

# **User Manual**



## **HFS 9000 Stimulus System**

**070-8365-03**

**Please check for change information  
at the rear of this manual.**

Copyright © Tektronix, Inc. 1994. All rights reserved.

Tektronix products are covered by U.S. and foreign patents, issued and pending. Information in this publication supercedes that in all previously published material. Specifications and price change privileges reserved.

Printed in the U.S.A.

Tektronix, Inc., P.O. Box 1000, Wilsonville, OR 97070-1000

TEKTRONIX and TEK are registered trademarks of Tektronix, Inc.

## WARRANTY

Tektronix warrants that this product will be free from defects in materials and workmanship for a period of one (1) year from the date of shipment. If any such product proves defective during this warranty period, Tektronix, at its option, either will repair the defective product without charge for parts and labor, or will provide a replacement in exchange for the defective product.

In order to obtain service under this warranty, Customer must notify Tektronix of the defect before the expiration of the warranty period and make suitable arrangements for the performance of service. Customer shall be responsible for packaging and shipping the defective product to the service center designated by Tektronix, with shipping charges prepaid. Tektronix shall pay for the return of the product to Customer if the shipment is to a location within the country in which the Tektronix service center is located. Customer shall be responsible for paying all shipping charges, duties, taxes, and any other charges for products returned to any other locations.

This warranty shall not apply to any defect, failure or damage caused by improper use or improper or inadequate maintenance and care. Tektronix shall not be obligated to furnish service under this warranty a) to repair damage resulting from attempts by personnel other than Tektronix representatives to install, repair or service the product; b) to repair damage resulting from improper use or connection to incompatible equipment; or c) to service a product that has been modified or integrated with other products when the effect of such modification or integration increases the time or difficulty of servicing the product.

**THIS WARRANTY IS GIVEN BY TEKTRONIX WITH RESPECT TO THIS PRODUCT IN LIEU OF ANY OTHER WARRANTIES, EXPRESSED OR IMPLIED. TEKTRONIX AND ITS VENDORS DISCLAIM ANY IMPLIED WARRANTIES OF MERCHANTABILITY OR FITNESS FOR A PARTICULAR PURPOSE. TEKTRONIX' RESPONSIBILITY TO REPAIR OR REPLACE DEFECTIVE PRODUCTS IS THE SOLE AND EXCLUSIVE REMEDY PROVIDED TO THE CUSTOMER FOR BREACH OF THIS WARRANTY. TEKTRONIX AND ITS VENDORS WILL NOT BE LIABLE FOR ANY INDIRECT, SPECIAL, INCIDENTAL, OR CONSEQUENTIAL DAMAGES IRRESPECTIVE OF WHETHER TEKTRONIX OR THE VENDOR HAS ADVANCE NOTICE OF THE POSSIBILITY OF SUCH DAMAGES.**



# Table of Contents

<b>General Safety Summary</b> .....	<b>xi</b>
<b>Preface</b> .....	<b>xv</b>
<b>Getting Started</b>	
Product Description .....	1-1
A Brief Tour .....	1-2
Part 1: Reset the HFS 9000 .....	1-2
Part 2: Set the Time Base .....	1-6
Part 3: Turn On Pulse Output .....	1-10
Part 4: Setting Up a Data Time Generator .....	1-11
<b>Operating Basics</b>	
<b>An Operator Overview</b> .....	<b>2-1</b>
<b>Calibration</b> .....	<b>2-7</b>
<b>Channels</b> .....	<b>2-9</b>
<b>Data Time Generators</b> .....	<b>2-13</b>
<b>Deskew</b> .....	<b>2-25</b>
<b>GPIB</b> .....	<b>2-29</b>
<b>Levels</b> .....	<b>2-35</b>
<b>Phase Lock</b> .....	<b>2-39</b>
<b>Power On</b> .....	<b>2-43</b>
<b>Pulse Generators</b> .....	<b>2-45</b>
<b>Reset</b> .....	<b>2-51</b>
<b>RS-232-C</b> .....	<b>2-53</b>
<b>Saved Settings</b> .....	<b>2-57</b>
<b>Self Test</b> .....	<b>2-59</b>
<b>Time Base</b> .....	<b>2-61</b>
<b>Trigger</b> .....	<b>2-67</b>
<b>Reference</b>	
<b>Setting Up the Instrument</b> .....	<b>3-1</b>
Controllers .....	3-1
Using the GPIB Interface .....	3-1
<b>Command Syntax</b> .....	<b>3-9</b>
Clearing the HFS 9000 .....	3-9
Command and Query Structure .....	3-9
Command Entry .....	3-11
Argument Types .....	3-13
Data Formats .....	3-19

Syntax Diagrams .....	3-20
<b>Commands .....</b>	<b>3-21</b>
<b>Status and Events .....</b>	<b>3-129</b>
Registers .....	3-129
Queues .....	3-133
Event Handling Sequence .....	3-133
Conflicts .....	3-134
Messages .....	3-135
<b>Programming Examples .....</b>	<b>3-139</b>
Example 1: Setting Up a Pulse Channel .....	3-139
Example 2: Command/Query Usage with Error Handling .....	3-141
Example 3: Interacting With a User .....	3-144

## Appendices

<b>Appendix A: Accessories .....</b>	<b>A-1</b>
Standard Accessories .....	A-1
Optional Accessories .....	A-2
Power Cord Options .....	A-2
<b>Appendix B: Specifications .....</b>	<b>B-1</b>
Nominal Traits .....	B-1
Warranted Characteristics .....	B-8
Typical Characteristics .....	B-11
<b>Appendix C: Interface Specifications .....</b>	<b>C-1</b>
Interface Messages .....	C-1
Character Set (ASCII Chart) .....	C-2
Reserved Words .....	C-3
Using Debug Mode .....	C-4
GPIB Function Subsets .....	C-5
Wiring for Alternate RS-232-C Configurations .....	C-6
<b>Appendix D: Error Messages .....</b>	<b>D-1</b>
<b>Appendix E: Packing for Shipment .....</b>	<b>E-1</b>
<b>Appendix F: Performance Verification .....</b>	<b>F-1</b>
Required Test Equipment .....	F-1
Test Record .....	F-2
Verification Sequence .....	F-11
Self Test .....	F-11
Calibration .....	F-12
Check Procedures .....	F-13

Instrument Setup .....	F-13
Output Level Checks (HFS 9DG1 Card Only) .....	F-13
Output Level Checks (HFS 9DG2 and HFS 9PG2 Cards Only) .....	F-16
Output Level Checks (HFS 9PG1 Card Only) .....	F-19
Trigger Output Level .....	F-21
Rise Time and Fall Time Checks (HFS 9PG1 and HFS 9DG1 Cards Only) .....	F-22
Rise Time and Fall Time Checks (HFS 9PG2 and HFS 9DG2 Cards Only) .....	F-25
Edge Placement Checks .....	F-27
Frequency Accuracy Check .....	F-31
Phase Lock Check .....	F-34

**Glossary**

**Index**

## List of Figures

<b>Figure 1–1: MAIN MENU Button Location</b> .....	1–2
<b>Figure 1–2: Main Menu Display</b> .....	1–3
<b>Figure 1–3: The SELECT and Arrow Buttons</b> .....	1–3
<b>Figure 1–4: The Save/Recall Menu</b> .....	1–5
<b>Figure 1–5: The Reset Verification Dialog</b> .....	1–5
<b>Figure 1–6: The Time Base Menu</b> .....	1–6
<b>Figure 1–7: Time Base Relationships</b> .....	1–6
<b>Figure 1–8: Mode Set to Auto-Burst</b> .....	1–7
<b>Figure 1–9: The Time Base Menu After Adjustment</b> .....	1–8
<b>Figure 1–10: Pulse Generator, Data Time Generator, and Time Base Controls and Connectors</b> .....	1–10
<b>Figure 1–11: Setting the Signal Type</b> .....	1–12
<b>Figure 1–12: Viewing Channel Data</b> .....	1–13
<b>Figure 2–1: The Cal/Deskew Menu</b> .....	2–7
<b>Figure 2–2: Channel Locations</b> .....	2–9
<b>Figure 2–3: Channel Controls on an HFS 9PG2 Card</b> .....	2–10
<b>Figure 2–4: Channel Controls on an HFS 9DG1 Card</b> .....	2–10
<b>Figure 2–5: Channel Controls on an HFS 9DG2 Card</b> .....	2–10
<b>Figure 2–6: Pulse Menu, Showing Channel Selection</b> .....	2–11
<b>Figure 2–7: Levels Menu, Showing Channel Selection</b> .....	2–12
<b>Figure 2–8: Signal Menu, Showing Channel Selection</b> .....	2–12
<b>Figure 2–9: The Pulse Menu</b> .....	2–13
<b>Figure 2–10: The Signal Menu</b> .....	2–14
<b>Figure 2–11: The Signal Name Dialog Box</b> .....	2–15
<b>Figure 2–12: Signal Menu After Entering Signal Name</b> .....	2–15
<b>Figure 2–13: Naming a Bus</b> .....	2–16
<b>Figure 2–14: Viewing a Bus by Group</b> .....	2–16
<b>Figure 2–15: Assigning Signal Type</b> .....	2–17
<b>Figure 2–16: Changing the Display Order</b> .....	2–17
<b>Figure 2–17: The Data Edit Menu</b> .....	2–18
<b>Figure 2–18: The Vector Menu</b> .....	2–19
<b>Figure 2–19: The Data Fill Menu</b> .....	2–21
<b>Figure 2–20: A Block Filled with Fill Scale Set to 1</b> .....	2–22
<b>Figure 2–21: A Block Filled with Fill Scale Set to 3</b> .....	2–23



<b>Figure 2–22: The Data Copy Menu</b> .....	2–24
<b>Figure 2–23: The Cal/Deskew Menu</b> .....	2–25
<b>Figure 2–24: Deskewing Channels</b> .....	2–26
<b>Figure 2–25: GPIB Connector Location</b> .....	2–30
<b>Figure 2–26: SRQ Button and REMOTE Light Locations</b> .....	2–32
<b>Figure 2–27: The GPIB Menu</b> .....	2–33
<b>Figure 2–28: The Pulse Menu</b> .....	2–36
<b>Figure 2–29: The Levels Menu and Associated Display</b> .....	2–37
<b>Figure 2–30: The Time Base Card Connectors</b> .....	2–40
<b>Figure 2–31: The Time Base Menu with the PhaseLockIn Menu Item</b> .....	2–40
<b>Figure 2–32: Phase Lock In and Frame Sync In Timing Relationships</b> .....	2–41
<b>Figure 2–33: The Cal/Deskew Menu</b> .....	2–43
<b>Figure 2–34: A Typical Configuration Display</b> .....	2–43
<b>Figure 2–35: The Pulse Menu</b> .....	2–45
<b>Figure 2–36: The Save/Recall Menu with Reset and Factory Items</b> ..	2–51
<b>Figure 2–37: SERIAL PORT Connector Location</b> .....	2–54
<b>Figure 2–38: The RS-232 Menu</b> .....	2–55
<b>Figure 2–39: The Save/Recall Menu</b> .....	2–57
<b>Figure 2–40: The Cal/Deskew Menu</b> .....	2–59
<b>Figure 2–41: The Time Base and Cal/Deskew Menus</b> .....	2–61
<b>Figure 2–42: The Timing Diagram, Illustrating the Count Parameter</b> .....	2–62
<b>Figure 2–43: The Time Base and Cal/Deskew Menus</b> .....	2–67
<b>Figure 3–1: GPIB Connector Location</b> .....	3–2
<b>Figure 3–2: How to Stack GPIB Connectors</b> .....	3–3
<b>Figure 3–3: Typical GPIB Network Configurations</b> .....	3–4
<b>Figure 3–4: The GPIB Menu</b> .....	3–4
<b>Figure 3–5: Command Message Elements</b> .....	3–10
<b>Figure 3–6: Block Argument Example</b> .....	3–15
<b>Figure 3–7: Typical Syntax Diagrams</b> .....	3–20
<b>Figure 3–8: Reading Binary Encoded Data into a Channel</b> .....	3–62
<b>Figure 3–9: Reading Binary Encoded Data into Vectors</b> .....	3–120
<b>Figure 3–10: Reading ASCII Data into a Vector</b> .....	3–123
<b>Figure 3–11: The Standard Event Status Register (SESR)</b> .....	3–130
<b>Figure 3–12: The Status Byte Register (SBR)</b> .....	3–130
<b>Figure 3–13: The Device Event Status Enable Register (DESER)</b> ...	3–131

<b>Figure 3–14: The Event Status Enable Register (ESER) . . . . .</b>	<b>3–132</b>
<b>Figure 3–15: The Service Request Enable Register (SRER) . . . . .</b>	<b>3–132</b>
<b>Figure 3–16: Status and Event Handling Process . . . . .</b>	<b>3–134</b>
<b>Figure C-1: The Debug Window . . . . .</b>	<b>C–4</b>

# List of Tables

<b>Table 2–1: Output Voltage Limits</b> .....	<b>2–35</b>
<b>Table 2–2: Logic State of Outputs When Time Base Stopped</b> .....	<b>2–63</b>
<b>Table 3–1: BNF Symbols and Meanings</b> .....	<b>3–9</b>
<b>Table 3–2: Command Message Elements</b> .....	<b>3–10</b>
<b>Table 3–3: Comparison of Header On and Off Responses</b> .....	<b>3–11</b>
<b>Table 3–4: Commands Common to All GPIB Devices</b> .....	<b>3–21</b>
<b>Table 3–5: HFS 9000 Device Commands and Parameters</b> .....	<b>3–22</b>
<b>Table 3–6: FACTORY Front Panel Settings</b> .....	<b>3–36</b>
<b>Table 3–7: FACTORY Time Base Settings</b> .....	<b>3–37</b>
<b>Table 3–8: FACTORY Pulse and Data Time Generator Settings</b> ...	<b>3–37</b>
<b>Table 3–9: FPAN:KEY Front Panel Key Equivalents</b> .....	<b>3–50</b>
<b>Table 3–10: Results from *TST?</b> .....	<b>3–117</b>
<b>Table 3–11: SESR Bit Functions</b> .....	<b>3–130</b>
<b>Table 3–12: SBR Bit Functions</b> .....	<b>3–131</b>
<b>Table 3–13: No Event Messages</b> .....	<b>3–135</b>
<b>Table 3–14: Command Error Messages — CME Bit 5</b> .....	<b>3–135</b>
<b>Table 3–15: Execution Error Messages — EXE Bit 4</b> .....	<b>3–137</b>
<b>Table 3–16: Device Error Messages — DDE Bit 3</b> .....	<b>3–137</b>
<b>Table 3–17: System Event Messages — QYE Bit 2</b> .....	<b>3–138</b>
<b>Table 3–18: Execution Warning Messages — EXE Bit 4</b> .....	<b>3–138</b>
<b>Table B–1: Nominal Traits — HFS 9PG1 Output Performance</b> ....	<b>B–1</b>
<b>Table B–2: Nominal Traits — HFS 9PG2 Output Performance</b> ....	<b>B–2</b>
<b>Table B–3: Nominal Traits — HFS 9DG1 Output Performance</b> ....	<b>B–3</b>
<b>Table B–4: Nominal Traits — HFS 9DG2 Output Performance</b> ....	<b>B–3</b>
<b>Table B–5: Nominal Traits — Time Base</b> .....	<b>B–4</b>
<b>Table B–6: Nominal Traits — Performance to External Frequency Reference</b> .....	<b>B–4</b>
<b>Table B–7: Nominal Traits — Output Edge Placement Performance</b>	<b>B–5</b>
<b>Table B–8: Nominal Traits — Transducer In Performance</b> .....	<b>B–5</b>
<b>Table B–9: Nominal Traits — Skew Cal In Performance</b> .....	<b>B–5</b>
<b>Table B–10: Nominal Traits — Trigger In Performance</b> .....	<b>B–6</b>
<b>Table B–11: Nominal Traits — Trigger Out Performance</b> .....	<b>B–6</b>
<b>Table B–12: Nominal Traits — Power Requirements</b> .....	<b>B–6</b>
<b>Table B–13: Nominal Traits — System Memory Performance</b> ....	<b>B–6</b>

<b>Table B-14: Nominal Traits — HFS 9003 Mechanical</b>	<b>B-7</b>
<b>Table B-15: Nominal Traits — HFS 9009 Mechanical</b>	<b>B-7</b>
<b>Table B-16: Warranted Characteristics — HFS 9PG1 Output Performance</b>	<b>B-8</b>
<b>Table B-17: Warranted Characteristics — HFS 9PG2 Output Performance</b>	<b>B-8</b>
<b>Table B-18: Warranted Characteristics — HFS 9DG1 Output Performance</b>	<b>B-8</b>
<b>Table B-19: Warranted Characteristics — HFS 9DG2 Output Performance</b>	<b>B-9</b>
<b>Table B-20: Warranted Characteristics — Time Base</b>	<b>B-9</b>
<b>Table B-21: Warranted Characteristic — Performance to External Frequency Reference</b>	<b>B-9</b>
<b>Table B-22: Warranted Characteristics — Output Edge Placement Performance</b>	<b>B-9</b>
<b>Table B-23: Warranted Characteristics — Trigger Out Performance</b>	<b>B-10</b>
<b>Table B-24: Warranted Characteristics — Power Requirements</b>	<b>B-10</b>
<b>Table B-25: Warranted Characteristics — Environmental and Safety</b>	<b>B-10</b>
<b>Table B-26: Typical Characteristics — Time Base</b>	<b>B-11</b>
<b>Table B-27: Typical Characteristics — HFS 9PG1 Output Performance</b>	<b>B-11</b>
<b>Table B-28: Typical Characteristics — HFS 9PG2 Output Performance</b>	<b>B-12</b>
<b>Table B-29: Typical Characteristics — HFS 9DG1 Output Performance</b>	<b>B-12</b>
<b>Table B-30: Typical Characteristics — HFS 9DG2 Output Performance</b>	<b>B-12</b>
<b>Table B-31: Typical Characteristics — Performance to External Frequency Reference</b>	<b>B-13</b>
<b>Table B-32: Typical Characteristics — Transducer In Performance</b>	<b>B-13</b>
<b>Table B-33: Typical Characteristics — Trigger In Performance</b>	<b>B-13</b>
<b>Table B-34: Typical Characteristics — Trigger Out Performance</b>	<b>B-14</b>
<b>Table B-35: Typical Characteristics — Power Requirements</b>	<b>B-14</b>
<b>Table C-1: HFS 9000 Standard Interface Messages</b>	<b>C-1</b>
<b>Table C-2: The ASCII Character Set</b>	<b>C-2</b>
<b>Table C-3: Serial Port DB-9 Pin Assignments</b>	<b>C-6</b>
<b>Table C-4: Standard Accessory Cable Connections</b>	<b>C-7</b>
<b>Table C-5: Converter Wiring for 25-pin PCs</b>	<b>C-7</b>

<b>Table C-6: Converter Cable for 9-pin PCs1</b> .....	<b>C-8</b>
<b>Table D-1: Displayed Error Messages</b> .....	<b>D-1</b>
<b>Table F-1: Required Test Equipment</b> .....	<b>F-1</b>
<b>Table F-2: Trigger Output Level and Phase Lock Test</b> .....	<b>F-3</b>
<b>Table F-3: Test Record for HFS 9DG1 Card</b> .....	<b>F-4</b>
<b>Table F-4: Test Record for HFS 9DG2 Card</b> .....	<b>F-6</b>
<b>Table F-5: Test Record for HFS 9PG1 Card</b> .....	<b>F-7</b>
<b>Table F-6: Test Record for HFS 9PG2 Card</b> .....	<b>F-9</b>
<b>Table F-7: HFS 9DG1 Output Level Checks, First Settings</b> .....	<b>F-14</b>
<b>Table F-8: HFS 9DG1 Output Level Checks, Second Settings</b> .....	<b>F-14</b>
<b>Table F-9: HFS 9DG1 Output Level Checks, Third Settings</b> .....	<b>F-15</b>
<b>Table F-10: HFS 9DG1 Output Level Checks, Fourth Settings</b> .....	<b>F-15</b>
<b>Table F-11: HFS 9DG2 and HFS 9PG2 Output Level Checks, First Settings</b> .....	<b>F-17</b>
<b>Table F-12: HFS 9DG2 and HFS 9PG2 Output Level Checks, Second Settings</b> .....	<b>F-17</b>
<b>Table F-13: HFS 9PG2 Output Level Checks, Third Settings</b> .....	<b>F-18</b>
<b>Table F-14: HFS 9PG2 Output Level Checks, Fourth Settings</b> .....	<b>F-18</b>
<b>Table F-15: HFS 9PG1 Output Level Checks, First Settings</b> .....	<b>F-19</b>
<b>Table F-16: HFS 9PG1 Output Level Checks, Second Settings</b> .....	<b>F-20</b>
<b>Table F-17: HFS 9PG1 Output Level Checks, Third Settings</b> .....	<b>F-20</b>
<b>Table F-18: HFS 9PG1 Output Level Checks, Fourth Settings</b> .....	<b>F-21</b>
<b>Table F-19: Settings for Trigger Output Check</b> .....	<b>F-22</b>
<b>Table F-20: Settings for Rise Time and Fall Time Checks</b> .....	<b>F-23</b>
<b>Table F-21: DSO Settings for Rise/Fall Time Checks</b> .....	<b>F-24</b>
<b>Table F-22: Settings for Rise Time and Fall Time Checks</b> .....	<b>F-25</b>
<b>Table F-23: DSO Settings for Rise/Fall Time Checks</b> .....	<b>F-26</b>
<b>Table F-24: Settings for Edge Placement Checks</b> .....	<b>F-27</b>
<b>Table F-25: Lead Delay Limits for HFS 9PG1 and HFS 9PG2</b> .....	<b>F-28</b>
<b>Table F-26: Lead Delay Limits for HFS 9DG1 and HFS 9DG2</b> .....	<b>F-29</b>
<b>Table F-27: Width Variance Limits for HFS 9PG1</b> .....	<b>F-29</b>
<b>Table F-28: Width Variance Limits for HFS 9DG1</b> .....	<b>F-30</b>
<b>Table F-29: Width Limits for HFS 9PG1 and HFS 9PG2</b> .....	<b>F-30</b>
<b>Table F-30: Width Limits for HFS 9DG1</b> .....	<b>F-30</b>
<b>Table F-31: Width Limits for HFS 9DG2</b> .....	<b>F-31</b>
<b>Table F-32: Frequency Limits (HFS 9PG1 &amp; HFS 9DG1)</b> .....	<b>F-32</b>
<b>Table F-33: Frequency Limits (HFS 9PG2)</b> .....	<b>F-32</b>
<b>Table F-34: Frequency Limits (HFS 9G2)</b> .....	<b>F-33</b>



# General Safety Summary

Review the following safety precautions to avoid injury and prevent damage to this product or any products connected to it.

*Only qualified personnel should perform service procedures.*

## Injury Precautions

- |   |  |
|---|--|
| <b>Use Proper Power Cord</b>                  | To avoid fire hazard, use only the power cord specified for this product.  |
| <b>Avoid Electric Overload</b>                | To avoid electric shock or fire hazard, do not apply a voltage to a terminal that is outside the range specified for that terminal.  |
| <b>Ground the Product</b>                     | This product is grounded through the grounding conductor of the power cord. To avoid electric shock, the grounding conductor must be connected to earth ground. Before making connections to the input or output terminals of the product, ensure that the product is properly grounded. |
| <b>Do Not Operate Without Covers</b>          | To avoid electric shock or fire hazard, do not operate this product with covers or panels removed.   |
| <b>Use Proper Fuse</b>                        | To avoid fire hazard, use only the fuse type and rating specified for this product.  |
| <b>Do Not Operate in Wet/Damp Conditions</b>  | To avoid electric shock, do not operate this product in wet or damp conditions.  |
| <b>Do Not Operate in Explosive Atmosphere</b> | To avoid injury or fire hazard, do not operate this product in an explosive atmosphere.  |

## Product Damage Precautions

- |                                   |   |
|-----------------------------------|---|
| <b>Use Proper Power Source</b>    | Do not operate this product from a power source that applies more than the voltage specified. |
| <b>Provide Proper Ventilation</b> | To prevent product overheating, provide proper ventilation.                                   |

**Do Not Operate With Suspected Failures**

If you suspect there is damage to this product, have it inspected by qualified service personnel.

## Safety Terms and Symbols

**Terms in This Manual**

These terms may appear in this manual:



---

**WARNING.** *Warning statements identify conditions or practices that could result in injury or loss of life.*

---



---

**CAUTION.** *Caution statements identify conditions or practices that could result in damage to this product or other property.*

---

**Terms on the Product**

These terms may appear on the product:

DANGER indicates an injury hazard immediately accessible as you read the marking.

WARNING indicates an injury hazard not immediately accessible as you read the marking.

CAUTION indicates a hazard to property including the product.

**Symbols on the Product**

The following symbols may appear on the product:



DANGER  
High Voltage



Protective Ground  
(Earth) Terminal



ATTENTION  
Refer to  
Manual



Double  
Insulated



## Certifications and Compliances

**CSA Certified Power Cords** CSA Certification includes the products and power cords appropriate for use in the North America power network. All other power cords supplied are approved for the country of use.

**Compliances** Consult the product specifications for IEC Installation Category, Pollution Degree, and Safety Class.



# Preface

The *HFS 9000 User Manual* contains operating and programming information for the HFS 9003 and HFS 9009 Stimulus Systems. This manual contains the following sections:

- *Getting Started* provides a product description along with a brief tour of the HFS 9000.
- *Operating Basics* contains a graphical overview of the HFS 9000 followed by an alphabetical arrangement of topics. Each topic covers an essential aspect of operating the HFS 9000.
- *Reference* explains how to use the HFS 9000 over the General Purpose Interface Bus (GPIB) and describes the programming commands and the status and event reporting system. This section also includes programming examples of how to control the HFS 9000 over the GPIB.
- *Appendices* includes a list of product accessories, product specifications, interface specifications, and error messages. The final appendix is a complete performance verification procedure with forms that may be photocopied and used for recording test results.

## Related Manuals

The following manuals contain additional user, service, or reference information for the HFS 9000 products:

- *HFS 9003 Service Manual* (070-8564-00)
- *HFS 9009 Service Manual* (070-8366-01)
- *BitWriter User Manual* (070-8859-00)





# Getting Started

This section presents a product description followed by a brief tour of the HFS 9000 Stimulus System. The brief tour illustrates how easy it is to use the HFS 9000.

## Product Description

The HFS 9000 Stimulus System combines the capabilities of a complete data generator, pulse generator, and switch matrix in a single instrument. Together with a high-speed digitizing oscilloscope, the HFS 9000 provides a complete device characterization and test solution with unsurpassed accuracy and repeatability. Some of the outstanding characteristics of the HFS 9000 are as follows:

- *Multi-channel stimulus* — The HFS 9000 can be configured with up to 36 channels of output in one mainframe, and up to 640 channels across multiple phase-locked systems.
- *Independent edge placement* — This feature can be applied to all channels and is especially useful in characterizing synchronous components.
- *Up to 1 ps timing resolution* — The timing resolution is an order of magnitude greater than typical ECL gate delays. Combined with the multi-channel capability, this allows for setup and hold time margin testing by providing clock, data, set, and reset signals to the device under test.
- *Advanced trigger features* — The triggering is designed specifically to help in device characterization. Phase lock lets you synchronize the HFS 9000 to other signal sources. Trigger out deskew eliminates the timing delays introduced by cabling.
- *Mixed logic family testing* — The HFS 9000 can be configured to combine different kinds of pulse output in the same mainframe for characterizing mixed-logic components.
- *Exceptionally flexible formatting* — A high-speed card can provide data at a rate of up to 630 MB/sec, with a transition time of less than 250 ps. A variable rate card has a variable transition time between 800 ps to 6 ns.
- *Fully programmable digital architecture* — The HFS 9000 is a digital instrument throughout. This means that the HFS 9000 can be fully programmed through either the GPIB or RS-232-C interface. Programmed control is essential for automated, repeatable tests. In addition, the program capability of the HFS 9000 means that it will fit easily into your automated test system. A complete automated test facility can be configured from an

HFS 9000, a controller such as a PC, and a high-speed acquisition system such as the Tektronix 11801B Digital Sampling Oscilloscope.

- *Graphic display* — Sample waveforms show how the controls are set, and indicate visually the parameter that a particular control governs.
- *BitWriter Software* — (Optional) This software package provides a Microsoft Windows environment in which to program the HFS 9000 using an IBM-PC compatible computer. (The PC must include at least an 80386 processor with 640 kbytes minimum, a color monitor, a high-density 5.25-inch or 3.5-inch disk drive, a GPIB card, and a mouse.)

## A Brief Tour

You may choose to go through this tour very carefully, or you may elect to skip the tour and investigate the HFS 9000 on your own. If you do not take the tour, use the *Operating Basics* section that follows to answer any questions you encounter. The *Operating Basics* section also describes details and features not covered in the *Getting Started* section.

### Part 1: Reset the HFS 9000

Resetting the HFS 9000 to a known, factory-default state is useful when you begin a new task and need to “start fresh” with known default settings. Without resetting, the HFS 9000 could be left with one or more parameters set to values that interfere with the job you are trying to accomplish.

**Screen Menus.** The HFS 9000 implements controls as menus that are displayed on the front-panel screen. Figure 1–1 shows the location of the **MAIN MENU** button, which displays the top-level menu.

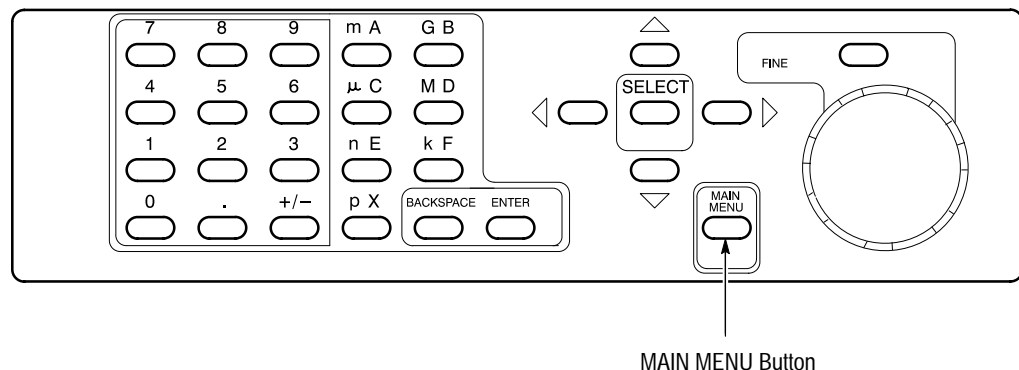

Figure 1–1: MAIN MENU Button Location

1. Press the **MAIN MENU** button.

Figure 1–2 shows the appearance of the Main menu. Each item in this menu leads to a second-level menu. The menu you see may have a different menu item highlighted, that is, black type on an amber background.

Main Menu			
press SELECT to show the Pulse Menu.			
Pulse Menu	Time Base Menu	Levels Menu	Signal Menu
Vector Menu	Data Edit Menu	Data Fill Menu	Data Copy Menu
Save/Recall Menu	GPiB Menu	RS-232 Menu	Cal/Deskew Menu

Figure 1–2: Main Menu Display

All menus have a name bar across the top and several rectangular menu items beneath. Some menus have a prompt line between the name bar and the menu items.

At all times, one and only one of the menu items is highlighted. The **SELECT** button (Figure 1–3) will operate on this highlighted item. The arrow keys surrounding the **SELECT** button let you change which item is highlighted; each arrow button moves the highlighting to the next item in the direction indicated.

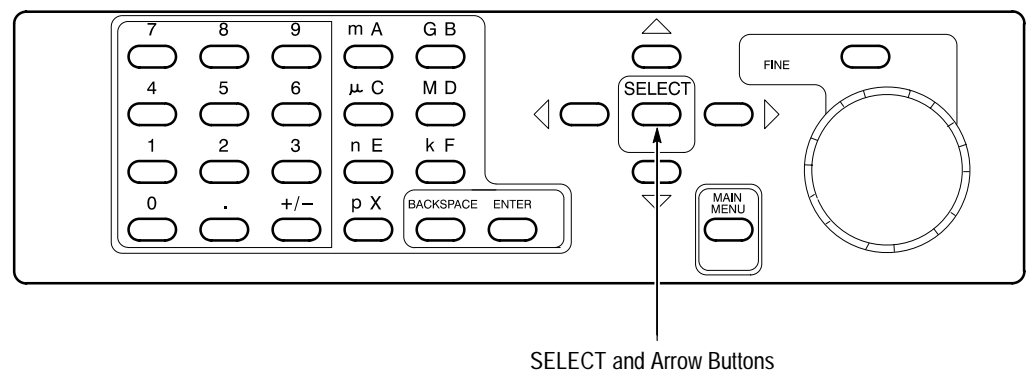

Figure 1–3: The SELECT and Arrow Buttons



The Main menu gives you access to the twelve second-level menus:

- The Pulse menu controls the pulse generator parameters such as pulse timing and voltage levels.
- The Time Base menu controls timing and triggering of the HFS 9000.
- The Levels menu sets voltage levels and limits for the pulse generators.
- The Signal menu controls channel display order, signal types, signal names, and channel view.
- The Vector menu controls vector parameters.
- The Data Edit menu lets you edit the data streams produced by data time generators.
- The Data Fill menu lets you fill data time generator channel memory.
- The Data Copy menu lets you copy blocks of data between data time generator channels.
- The Save/Recall menu lets you save and recall Stimulus System settings. This menu also has the reset control.
- The GPIB menu controls the GPIB parameters for remote programming.
- The RS-232 menu controls the serial port parameters for remote programming.
- The Cal/Deskew menu provides calibration, self-test, instrument identification, and pulse channel deskew functions.

The goal of this first part is to reset the HFS 9000. Since the reset control is in the Save/Recall menu, you need to display this menu next.

2. Use the arrow buttons surrounding the **SELECT** button to move the menu item highlight to the **Save/Recall Menu** item.
3. Press the **SELECT** button.

The Save/Recall menu, as shown in Figure 1–4, is displayed.

Save/Recall Menu			
Setting 1	Recall	Save	Purge
—	—	Reset	Factory

Figure 1-4: The Save/Recall Menu

Once in the Save/Recall menu, you can reset the HFS 9000 by selecting the Reset menu item.

4. Use the arrow buttons to move the menu item highlight to the **Reset** menu item.
5. Press the **SELECT** button.

Accidentally resetting the instrument can be inconvenient, especially if you have spent some time getting the perfect setup. For your protection, the HFS 9000 asks you to verify that you really want to reset.

To perform the verification, the HFS 9000 displays a temporary screen dialog, as shown in Figure 1-5.

```

This operation will discard the current
instrument setup.
Reset the instrument?
Yes
Cancel

```

Figure 1-5: The Reset Verification Dialog

You can select from the options in the dialog by using either the up and down Arrow keys, or by turning the knob. Once you have the proper selection, press **SELECT** to perform the verified action.

6. Make certain that the **Yes** choice in the dialog is highlighted, and then press the **SELECT** button to verify the reset request.

After the HFS 9000 resets, it displays the Main menu.

**Part 2: Set the Time Base**

The HFS 9000 provides several pulse or data time generation channels, but they are all governed by a single time base. The next several steps set up the time base to trigger itself repeatedly, and to have the time base specify a predetermined number of pulses from the pulse or data time generators.

The controls for the time base are found in the Time Base menu, shown in Figure 1-6.

1. Use the arrow buttons to highlight the **Time Base** menu, then press the **SELECT** button to display the Time Base menu.

Time Base Menu			
press SELECT: ▶ Auto Burst Auto-Burst Trig-Auto			
Mode	Period	Count	Out Period
Auto	5ns	64	1
Trigger In	Trig Slope	Trig Level	PhaseLockIn
On	Positive	-1.3V	Off
Run/Stop	—	—	—
Running			

**Figure 1-6: The Time Base Menu**

The highlighted menu item is **Mode**, which you need to set for this example. The time base normally waits for a trigger event, then specifies **Count** number of pulses to be generated. After that, the time base pauses for a re-arm time and then waits for the next trigger event. The display screen above the Time Base menu graphically depicts this sequence. (see Figure 1-7).

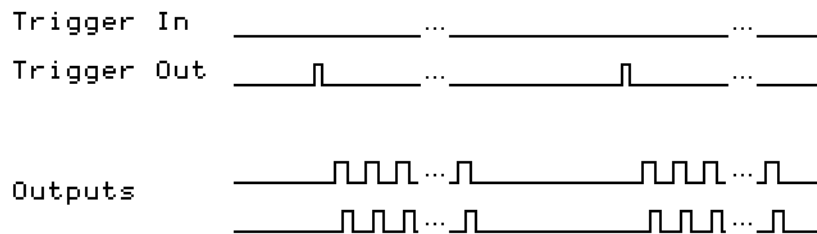

**Figure 1-7: Time Base Relationships**

The **Mode** control has four possible settings:

- **Burst** mode produces a burst of pulses whenever a trigger event is detected.
- **Auto-Burst** mode does not wait for a trigger before generating a burst of pulses.
- **Auto** mode generates a continuous stream of pulses without waiting for a trigger or delaying for re-arm time.
- **Trig-Auto** mode works like Auto mode except it does not begin until it receives a trigger event.

To keep this example simple, we will use **Auto Burst** mode.

Set the mode control with the **SELECT** button. The prompt line, just below the menu title, shows you the current mode setting with an arrow (▶). Each time you press **SELECT**, the arrow moves to a different setting and the text in the **Mode** item changes.

2. Press the **SELECT** button twice. When you are done, the prompt line should appear as in Figure 1–8.

```

Time Base Menu
press SELECT: Auto Burst▶Auto-Burst Trig-Auto
Mode
Auto-Burst

```

Figure 1–8: Mode Set to Auto-Burst

Two other items in the top line of the Time Base menu, **Period** and **Count**, control the generated pulses. When either of these items is highlighted, the waveform display above the menu is augmented to more clearly illustrate the parameter being adjusted with that item.

- **Period** controls the timing of the individual pulses produced by the pulse generators. This can also be changed to be a **Frequency** control, as will be demonstrated later in this tour.
- **Count** determines the number of pulses generated after the startup delay.

Both of these items can be adjusted with the knob or each can be entered using the keypad. When using the knob, the **FINE** button above the knob can give you more control through finer resolution.

3. Use the arrow keys to highlight the **Period** item.

- Use the knob to adjust the period to 6.25 ns. This will require that you use the fine control.

First, use the knob to set the **Period** to 6.2 ns. Then, press the **FINE** button to make the knob increments smaller. Note that the **FINE** light turns on. Finally, use the knob to set it to 6.25 ns.

Numeric values can also be entered through the keypad. Type in the number, and, if needed, press a key to specify the unit prefix (p, n,  $\mu$ , m, k, M, or G). Indicate that you are finished by pressing the **ENTER** key. You never need to enter the units, such as seconds or Volts. If you make a mistake, the **BACKSPACE** key will back up character by character.

- Use the arrow keys to highlight the **Count** item.
- Enter the value 5 by pressing **5** and **ENTER**.

As mentioned above, the **Period** item can be changed to specify **Frequency** instead. Period and frequency are two ways of specifying the same parameter. When you use the **SELECT** button to change modes of this item, the readout shows you the setting in that mode.

- Use the arrow keys to highlight the **Period** item. Observe that the period setting is 6.25 ns.
- Press the **SELECT** button. Observe that the item changes to **Frequency** and that the frequency setting is 160 MHz, the reciprocal of 6.25 ns.
- Use the knob or the keypad to set the frequency to 150 MHz. If you left the Fine knob control on from Step 4, turn it off to set the frequency quickly.

You have now set up the HFS 9000 to enable the output of pulses. You will see the results in the next part, but first check to make sure your Time Base menu appears as shown in Figure 1-9.

Time Base Menu			
press SELECT: Period▶Frequency			
Mode	Frequency	Count	Out Period
Auto-Burst	150MHz	5	1
Trigger In On	Trig Slope Positive	Trig Level -1.3V	PhaseLockIn Off
Run/Stop Running	—	—	—

Figure 1-9: The Time Base Menu After Adjustment

The other settings do not require adjustment for this tutorial example. Since the HFS 9000 is in **Auto-Burst** mode, no input trigger is needed to generate pulses.

**The UNDO Button.** Whenever you change a setting, the HFS 9000 remembers the old setting as well. Should you then change your mind, you can press the **UNDO** button. The **UNDO** button is located to the right of the display panel. Pressing the **UNDO** button twice cancels the undo.

- 10.** Press the **UNDO** button. Note that the original frequency setting of 160 MHz is restored.
- 11.** Press the **UNDO** button again. Note that your changed value, 150 MHz, is returned.

**Part 3: Turn On Pulse Output**

The pulse and data time generators are all synchronized by the time base, but currently none of the pulse or data time generator channels are switched on. You can turn on any channel from the Pulse menu, but it is easiest to turn on a channel from the front panel.

Depending on the configuration of your HFS 9000, you have from one to nine pulse generator cards, with up to four channels each. The controls for each card appear as in Figure 1–10.

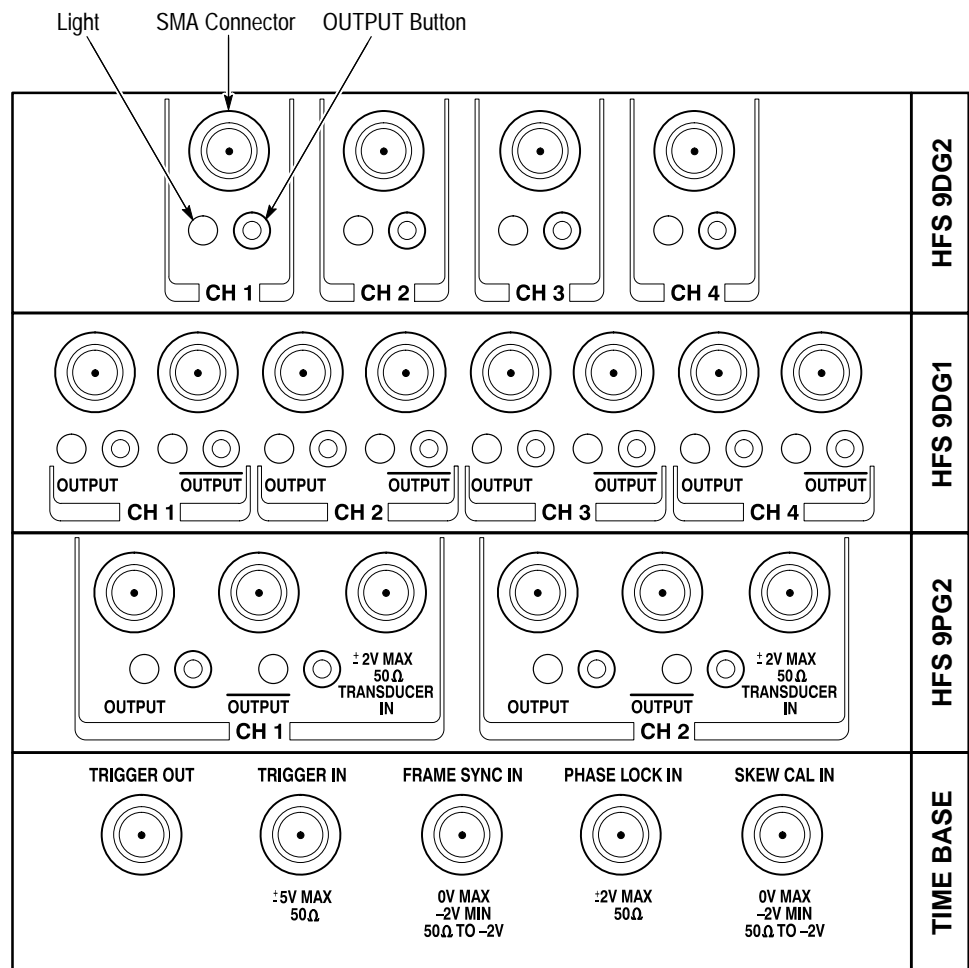

**Figure 1–10: Pulse Generator, Data Time Generator, and Time Base Controls and Connectors**

1. Select any channel to use for output, and press the **OUTPUT** button for that channel. Observe that the associated light turns on.

The HFS 9000 is now creating pulse trains. It puts out 5 pulses of 150 MHz frequency. When that is done, it automatically starts over after the re-arm time. If you have an oscilloscope, you can view the pulses that are being generated.

2. Connect a cable from the associated **OUTPUT** connector to the signal input connector of your oscilloscope.
3. Adjust your oscilloscope for a stable display of the pulses. If necessary, you can also connect a cable from the Time Base card **TRIGGER OUT** connector to the external trigger connector of your oscilloscope.

You may also observe the normal Burst mode operation of the HFS 9000.

4. Use the arrow keys on the HFS 9000 to highlight the **Mode** item of the Time Base menu. Use the **SELECT** button to select **Burst** mode.
5. Observe that the oscilloscope is no longer triggered and displaying a signal.
6. Press the **MANUAL TRIGGER** button (to the right of the display panel). Observe that each time you press this button, the oscilloscope shows one and only one burst of output from the HFS 9000.

#### Part 4: Setting Up a Data Time Generator

If a Data Time generator is installed in your HFS 9000, it can produce data streams for device testing in addition to generating pulses. You can perform the following steps only if your HFS 9000 has an HFS 9DG1 or HFS 9DG2 card installed.

1. Perform all steps in “Reset the HFS 9000” of *Getting Started*, to reset all HFS 9000 parameters to the factory defaults.
2. Use the arrow keys to highlight the **Pulse** menu, then press the **SELECT** button to display the Pulse menu.
3. Using the **Channel** menu item, select a channel located on a data time generator card.

For a channel to generate a data stream, the signal type of the channel must be set appropriately. The available signal types are: **NRZ**-Non-Return to Zero; **RZ**, Return-to-Zero; and **R1**, Return-to-One. A data time generator channel can also be set to **DC** (direct current).

4. Highlight the **Signal Type** menu item in the Pulse menu. (Figure 1–11). Turn the knob to change the signal type.



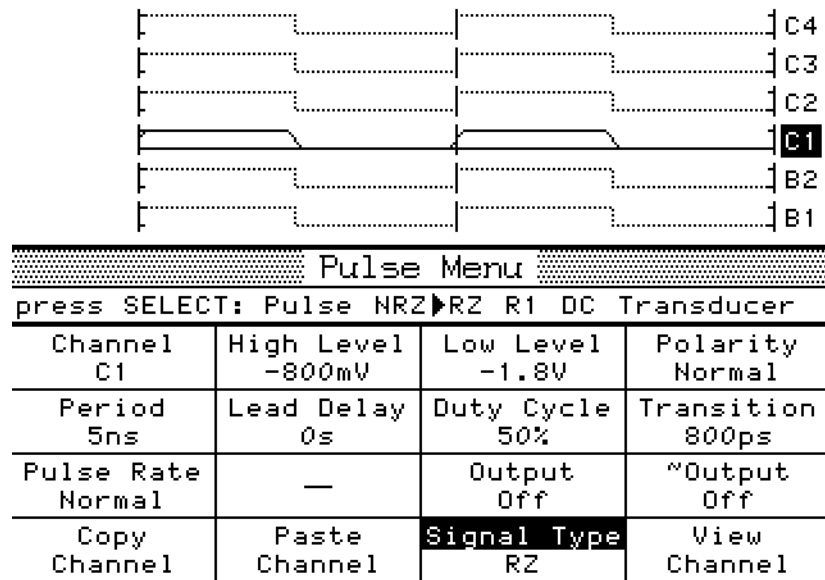

Figure 1-11: Setting the Signal Type

- Observe how the illustration at the top of the display changes with the signal type. Set the signal type to **NRZ**.
- Press the **MAIN MENU** button.
- Use the arrow keys to highlight the **Data Fill** menu and press the **SELECT** button.

A channel is initially filled with zeros. You can change the data in the channel using the Data Fill menu or by editing the data in the channel one bit at a time in the Data Edit menu. The Data Fill menu is the quickest method for placing data in a channel using the front panel.

The commands in the Data Fill menu work on a “Block” of vectors. A Block is defined by a start vector and an end vector. Initially the block start and end vectors are set to 0.

- Highlight the **Block End** menu item. On the numeric keypad, press **1**, **5**, and **ENTER**. This sets the block end vector to 15.

Blocks are filled using the **Fill Block with Method** menu item. The three parameters for this menu item are **Constant**, **Method**, and **Fill Scale**. **Constant** provides the value used to fill a block or the starting value for the **Count Up**, **Count Down** and **Random** fill methods. **Method** specifies how a channel is filled with data; the options are Constant, Invert, Count Up, Count Down, and Random. **Fill Scale** is the number of vectors that are filled with a value before generating a new fill value.

9. To set the fill method, use the arrow keys to highlight the **Method** menu item.
10. Turn the knob to select each of the different fill methods. Observe the descriptions that appear above the menu.
11. Select the Constant method.
12. Use the arrow keys to highlight the **Fill Block with Method** menu item. Press the **SELECT** key.
13. A menu will appear informing you that the operation cannot be undone. Press the **SELECT** key to allow the operation to proceed.

To view the results of the fill operation, you can view the channel data in the Data Edit menu.

14. Press the **MAIN MENU** button. Highlight the **Data Edit Menu** item and press **SELECT**.

When the Data Edit menu appears, you will see the selected channel and the data that has filled it.

```

Press
Select
to view
other
Vectors
      C
      1
-----
000000 SL 1
000001      1
000002      1
000003      1
000004      1
000005      1
000006      1
000007 E: 1
000008      1
000009      1
000010      1
000011      1
000012      1
000013      1
-----
Data Edit Menu

```

Figure 1-12: Viewing Channel Data

You can edit each of the bits in the channel from the front panel. Select a bit by turning the knob and enter a new value from the numeric keypad.

**15.** Turn the knob to highlight vector 7.

**16.** Press 0 on the numeric keypad.

Observe that the 1 in vector address 7 is replaced by a 0 and the cursor moves down to the next vector.

This completes your brief tour of the HFS 9000 Stimulus System. Refer to the *Operating Basics* and *Reference* sections in this manual for more details on operating your HFS 9000.



# An Operator Overview

The Operating Basics section is arranged as an alphabetic list of topics. Each topic covers one aspect of the operation of the HFS 9000. The topics that follow this operator overview are:

Calibration	Pulse Generators
Channels	Reset
Data Time Generators	RS-232-C
Deskew	Saved Settings
GPIB	Self Test
Levels	Time Base
Phase Lock	Trigger
Power On	

## Timing and Pulses (Burst and Auto-Burst Modes)

The Frequency or Period setting determines the frequency or duration of the pulse windows. See page 2-62.

The Count setting determines the number of pulse windows in a burst — see page 2-62. Pulses may occur at any time and be any width within the pulse window. Each channel may independently set such pulse parameters as width, phase, lead delay, and trailing delay. See page 2-45.

The Out Period setting determines which pulse window the output trigger is associated with; in this case it is the third pulse window. See page 2-62.

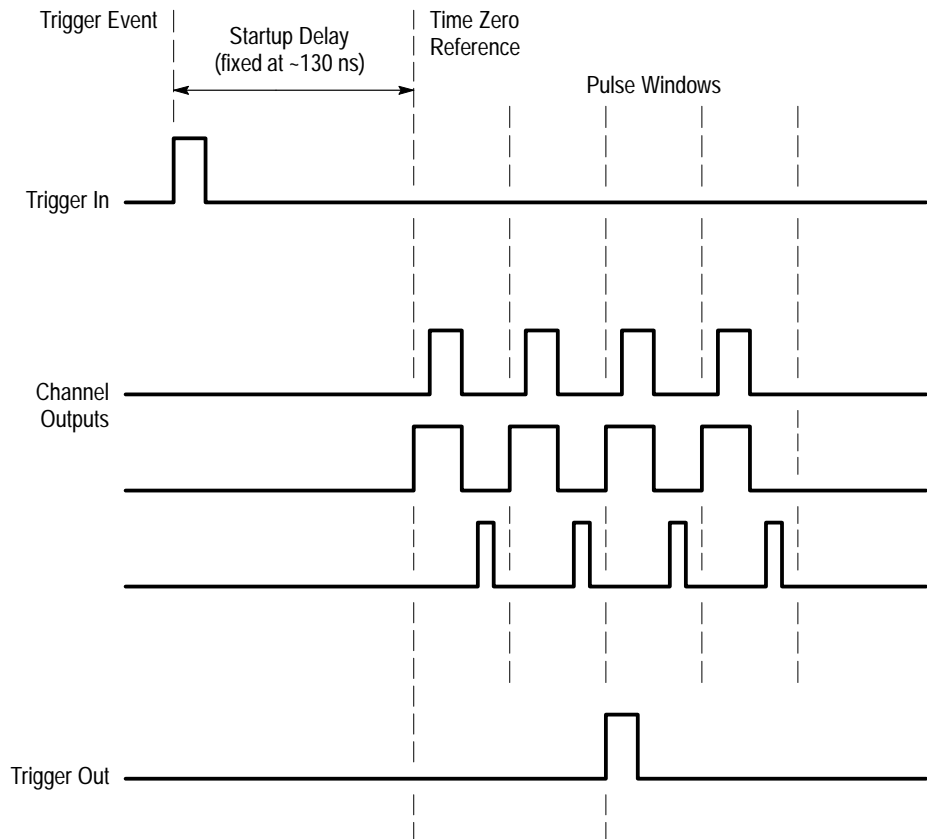

## The HFS 9003 Front Panel

NEXT CHANNEL and PREVIOUS CHANNEL buttons let you select a channel in menus that have channel parameters. This convenience avoids a lot of menu navigation. See page 2-11.

The UNDO button restores the HFS 9000 to the state it was in before your last change. When you change menus, you can no longer undo the previous operation.

The Generator cards have connectors for normal OUTPUT and inverted OUTPUT, along with buttons to turn the outputs on and off and lights to indicate whether those outputs are on. The TRANSDUCER IN connector (PG cards only) lets you apply a logic signal to directly drive a channel. See pages 2-13 and 2-45.

The Time Base card has connectors for timing input and output, including the TRIGGER IN, TRIGGER OUT connectors (see page 2-65), the PHASE LOCK IN and FRAME SYNC IN connectors (see page 2-41), and the SKEW CAL IN connector (see page 2-7).

REMOTE light and SRQ button — used for operator interaction when the HFS 9000 is controlled from a computer or controller. See page 2-31.

RUN/STOP lets you start and stop the time base as necessary. The RUNNING light indicates whether or not the time base is running.

The MANUAL TRIGGER button simulates a trigger event that normally occurs as a signal at the TRIGGER IN connector. See page 2-68.

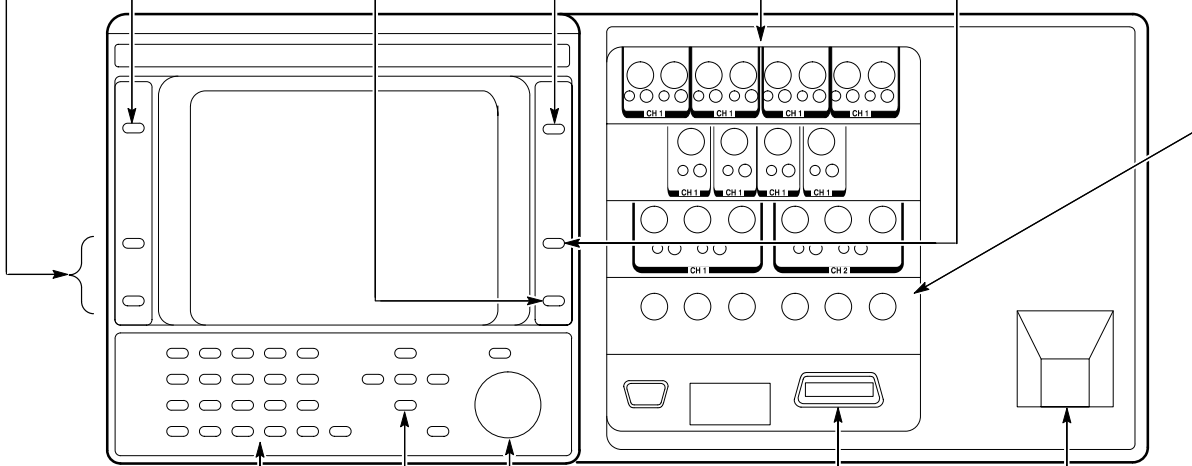

Numeric keypad lets you type a number for any selected menu item having a numeric value. End your number by pressing the ENTER button. See page 1-8.

The knob and FINE button let you adjust the value of any selected menu item that has a numeric value. The FINE button gives you finer knob control. The FINE light tells you when the knob is in fine granularity mode. See page 1-7.

ON/STANDBY switch turns on the HFS 9000 or turns it off (standby). Even when on standby, some circuits have line power applied. To remove all power, disconnect the power cord from the HFS 9000.

SELECT, arrow, and MAIN MENU buttons navigate through the menus. MAIN MENU displays the main menu. The arrow buttons change which menu item is selected — see page 2-4. In the main menu, SELECT displays the selected menu. In other menus, SELECT may perform an action or change the way an item works — see page 1-7.

The CPU card has connectors for the SERIAL PORT (see page 2-53) and for the GPIB bus (see page 2-29).

## The HFS 9009 Front Panel

SELECT, arrow, and MAIN MENU buttons navigate through the menus. MAIN MENU displays the main menu. The arrow buttons change which menu item is selected — see page 2-4. In the main menu, SELECT displays the selected menu. In other menus, SELECT may perform an action or change the way an item works — see page 1-7.

ON/STANDBY switch turns on the HFS 9000 or turns it off (standby). Even when on standby, some circuits have line power applied. To remove all power, disconnect the power cord from the HFS 9000.

The knob and FINE button let you adjust the value of any selected menu item that has a numeric value. The FINE button gives you finer knob control. The FINE light tells you when the knob is in fine granularity mode. See page 1-7.

The REMOTE light and SRQ button are used for operator interaction when the HFS 9000 is controlled from a computer or controller. See page 2-31.

The UNDO button restores the HFS 9000 to the state it was in before your last change. When you change menus, you can no longer undo the previous operation.

The MANUAL TRIGGER button simulates a trigger event that normally occurs as a signal at the TRIGGER IN connector. See page 2-68.

RUN/STOP lets you start and stop the time base as necessary. The RUNNING light indicates whether the time base is running or not.

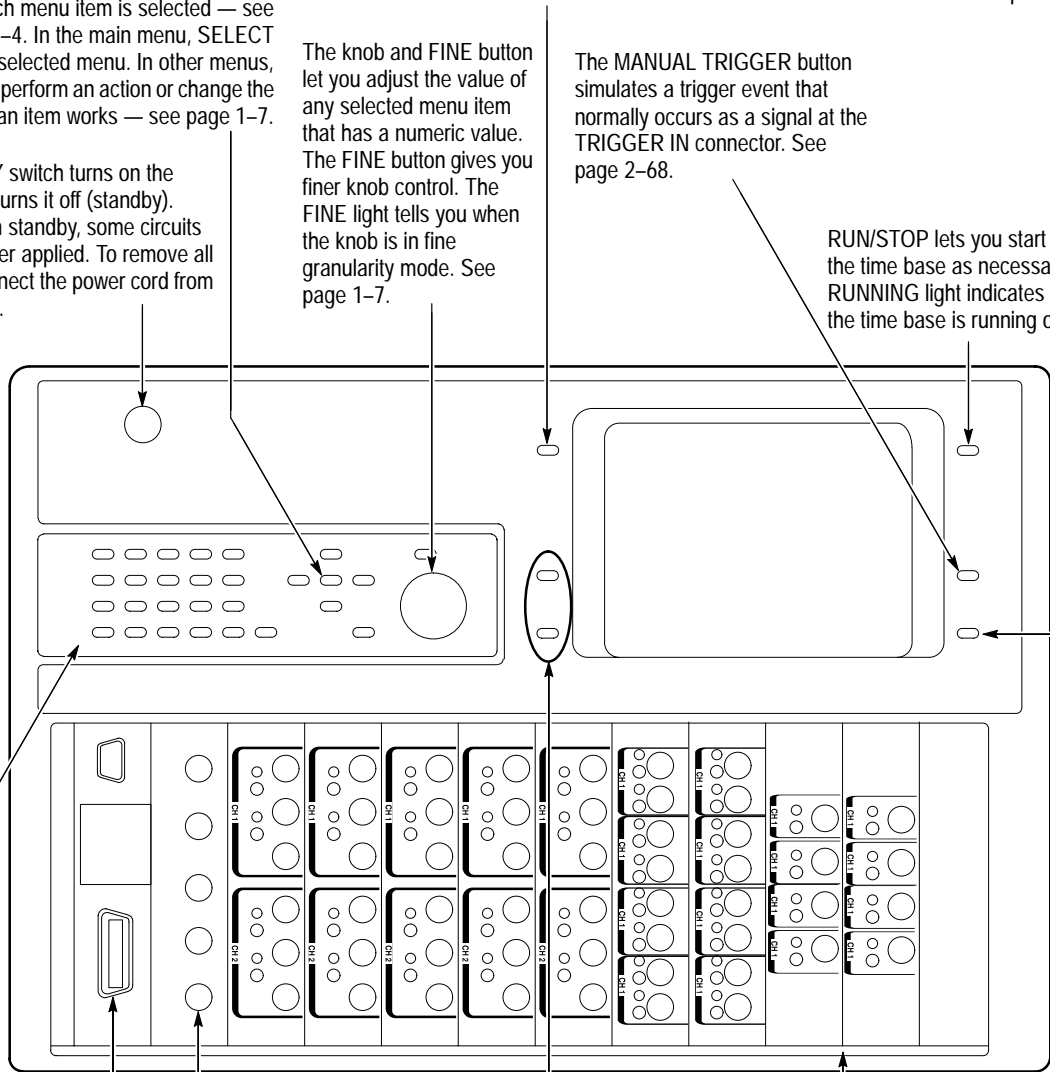

Numeric keypad lets you type a number for any selected menu item having a numeric value. End your number by pressing the ENTER button. See page 1-8.

The Time Base card has connectors for timing input and output, including the TRIGGER IN and TRIGGER OUT connectors (see page 2-65), the PHASE LOCK IN and FRAME SYNC IN connectors (see page 2-41), and the SKEW CAL IN connector (see page 2-7).

The Pulse Generator cards have connectors for normal OUTPUT and inverted OUTPUT, along with buttons to turn the outputs on and off and lights to indicate whether those outputs are on. The TRANSDUCER IN connector lets you apply a logic signal to directly drive a channel. See pages 2-13 and 2-45.

The CPU card has connectors for the SERIAL PORT (see page 2-53) and for the GPIB bus (see page 2-29).

NEXT CHANNEL and PREVIOUS CHANNEL buttons let you select a channel in menus that have channel parameters. This convenience avoids a lot of menu navigation. See page 2-11.

## Menu Navigation

1. Press the MAIN MENU button to display the top-level menu.

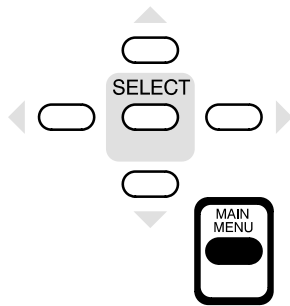

Main Menu			
press SELECT to show the Pulse Menu.			
Pulse Menu	Time Base Menu	Levels Menu	Signal Menu
Vector Menu	Data Edit Menu	Data Fill Menu	Data Copy Menu
Save/Recall Menu	GPIB Menu	RS-232 Menu	Cal/Deskew Menu

2. Use the arrow buttons to move to the menu you want to display.

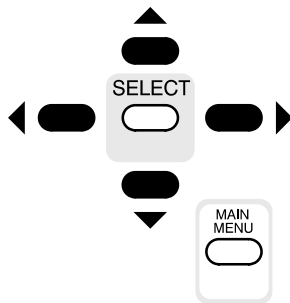

Main Menu			
press SELECT to show the Time Base Menu.			
Pulse Menu	<b>Time Base Menu</b>	Levels Menu	Signal Menu
Vector Menu	Data Edit Menu	Data Fill Menu	Data Copy Menu
Save/Recall Menu	GPIB Menu	RS-232 Menu	Cal/Deskew Menu

3. Press the SELECT button to display that menu.

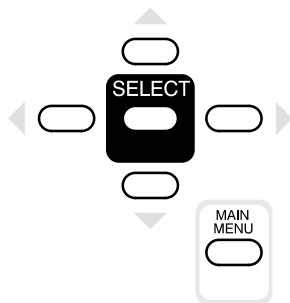

Time Base Menu			
press SELECT: Auto Burst▶Auto-Burst Trig-Auto			
<b>Mode</b>	<b>Period</b>	<b>Count</b>	<b>Out Period</b>
Auto-Burst	1.7ns	1	1
Trigger In On	Trig Slope Positive	Trig Level 0V	PhaseLockIn Off
Run/Stop Running	—	—	—



# Menu Map

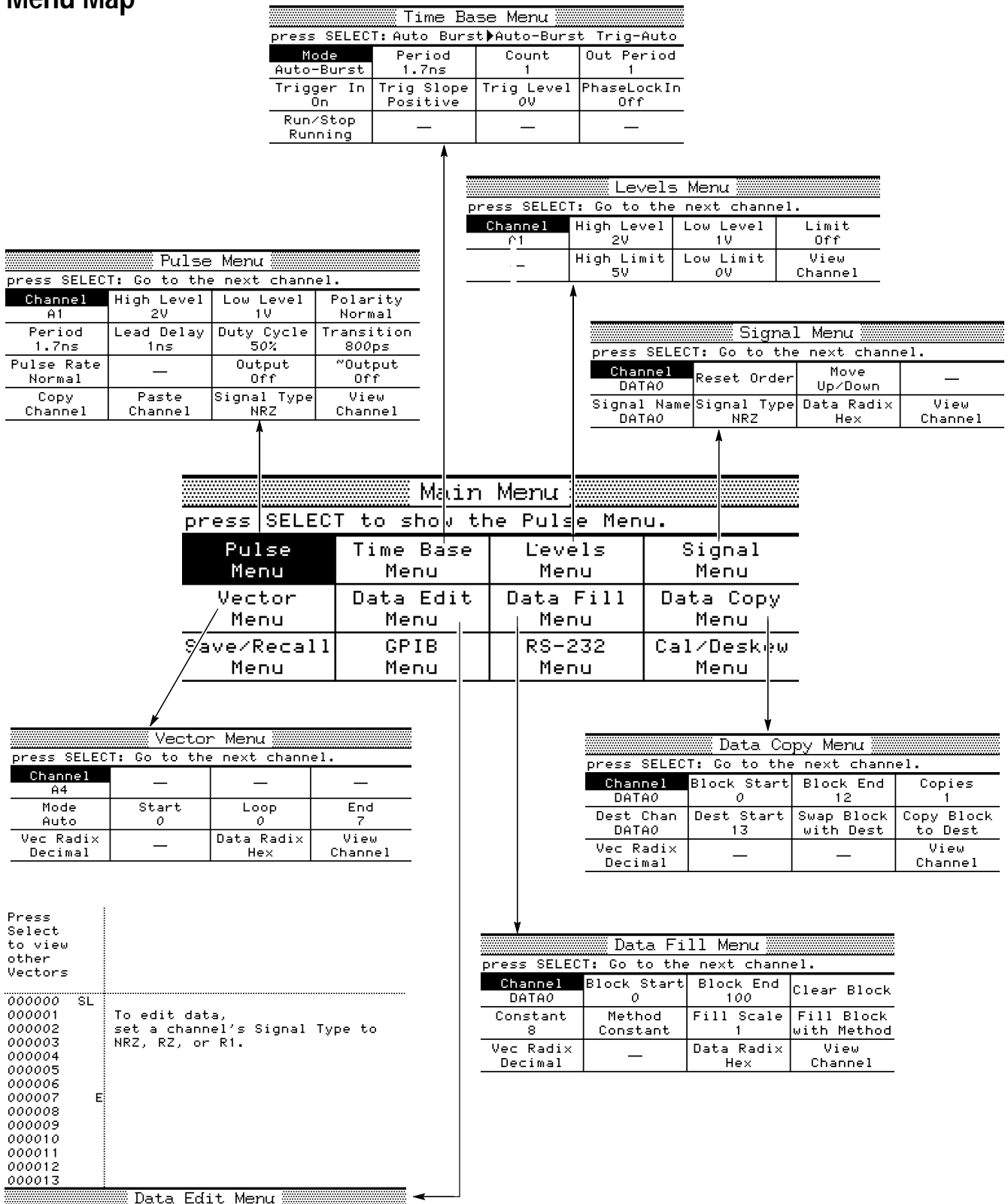

## Menu Map (Cont.)

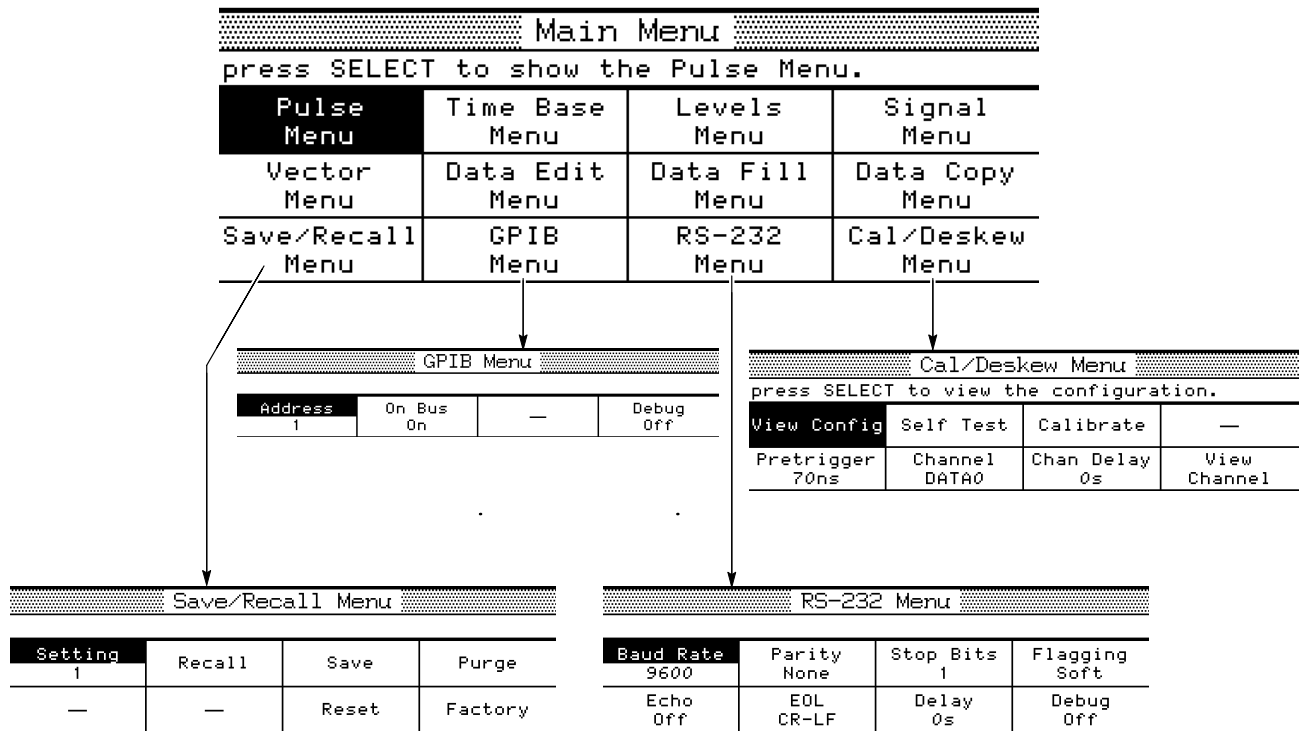

# Calibration

The HFS 9000 is shipped in a calibrated state, with the outputs deskewed to the front panel. Calibration settings are saved in a special non-volatile memory which is separate from any other memory in the instrument. Calibration adjusts the instrument to its internal voltage and timing references.

## Calibrating the HFS 9000

It is important to calibrate the HFS 9000 after the instrument has been repaired or after the instrument has been reconfigured by adding or changing cards. It is also necessary to calibrate the HFS 9000 if you operate the instrument in an environment where the ambient temperature differs by more than 5° C from the temperature of the last calibration. As a matter of routine, you should calibrate the HFS 9000 every six months.

To calibrate the HFS 9000, use the **Calibrate** item in the Cal/Deskew menu. Figure 2-1 shows this menu.

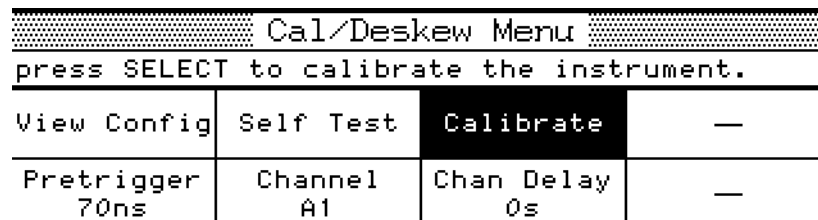

```
Cal/Deskew Menu
press SELECT to calibrate the instrument.
View Config  Self Test  Calibrate  —
Pretrigger   Channel   Chan Delay  —
  70ns       A1          0s
```

Figure 2-1: The Cal/Deskew Menu

Run the calibration procedure only when the HFS 9000 has been powered on for 20 minutes in the temperature environment you expect it to be used. You will need a 20 inch SMA cable; the cable supplied as a standard accessory is acceptable. The calibration process will take approximately one minute for every channel installed in the HFS 9000.

When you select the Calibrate item in the Cal/Deskew menu, a dialog box asks you for verification. If you proceed, the HFS 9000 will prompt you to attach the SMA cable from the front panel **SKEW CAL IN** connector first to the **TRIGGER OUT** connector, and then to each channel **OUTPUT** connector in turn. During the time that the channels are connected, calibration is performed automatically.

## Diagnostic Failure of Calibration Memory

Whenever you power on the HFS 9000, diagnostics check the integrity of the calibration memory. If the test fails, the instrument may require service. When this happens, nominal values are put into calibration memory, and the instrument will be uncalibrated. However, the HFS 9000 will let you continue to operate the instrument after the initial warning that calibration memory has been reset. Check out the instrument to be certain it is running correctly and run the calibration procedure before operating the instrument.

If the instrument configuration has been changed since last power on (for example, boards have been changed or firmware memory has been updated), the power-on diagnostics will detect this as a failure of calibration memory integrity. Run the calibration procedure before operating the instrument.

---

**NOTE.** *Some features will not function if the HFS 9000 is in an uncalibrated state.*

---

# Channels

You have from 2 to 36 channels of output, depending on the type and number of cards you have installed in your HFS 9000 system. The HFS 9PG1 and HFS 9PG2 pulse generator cards provide two output channels, while the HFS 9DG1 and HFS 9DG2 data time generator cards provide four output channels.

## Channel Names

Each pulse generator card is assigned the letter designation A, B, C, D, E, F, G, H, or I depending on its physical position in the Stimulus System mainframe.

The channels on HFS 9PG1 and HFS 9PG2 cards are numbered 1 and 2. The channels on HFS 9DG1 and HFS 9DG2 cards are numbered 1, 2, 3, and 4. The full designation for a channel is a letter and a number; for example A1, C2, H4, etc. Figure 2–2 shows the locations of the channels in a typical instrument.

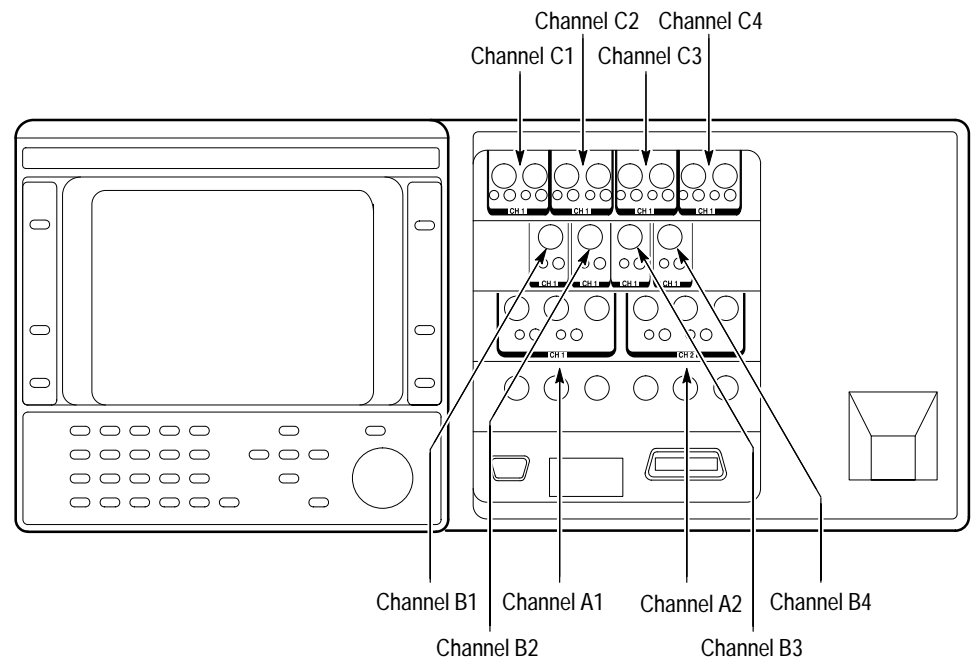

Figure 2–2: Channel Locations

## Channel Controls

On HFS 9PG1, HFS 9PG2, and HFS 9DG1 cards, each channel has both normal **OUTPUT** and inverted **OUTPUT** connectors. The HFS 9DG2 card has only one connector per channel, **OUTPUT**. Each output connector of each channel has a button to turn on or off that output, and a light telling whether or not that output is on. In addition, each channel on HFS 9PG1 and HFS 9PG2 cards have a **TRANSDUCER IN** connector. (For more information on the Transducer mode, see page 2-49.) Figures 2-3, 2-4, and 2-5 show the layout of controls for the different pulse and data time generator cards.

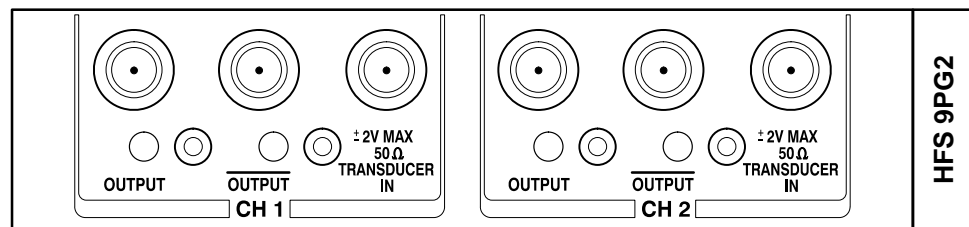

Figure 2-3: Channel Controls on an HFS 9PG2 Card

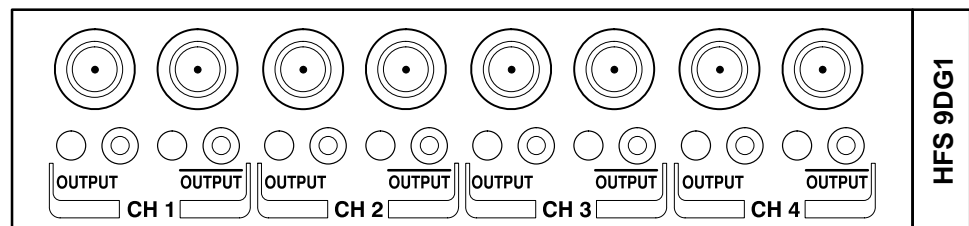

Figure 2-4: Channel Controls on an HFS 9DG1 Card

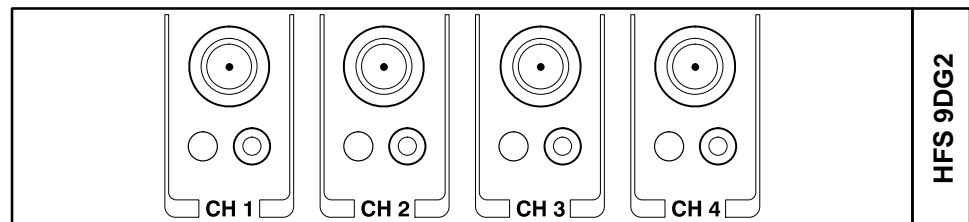

Figure 2-5: Channel Controls on an HFS 9DG2 Card

You can also turn off normal and inverted output for any channel with the Pulse menu items **Output** and **~Output**. When an output is off, the channel is internally tri-state. Off does not drive an output to ground.

## Selecting Channels

Several menus provide controls that apply to individual channels. In these menus, the upper left menu item lets you set which channel the other menu items control. You use the **SELECT** button or the knob to select the desired channel. Once you have set the desired channel, you can use the other menu items to control the parameters for that channel.

An alternate method of selecting channels is to use the **NEXT CHANNEL** and **PREVIOUS CHANNEL** buttons at the left of the display.

The Pulse menu, the Levels menu, and the Signal menu have associated channel displays above the menu. In these displays, each channel is labeled with its channel name (A1, C2, etc.). The name of the channel that is selected to be controlled by the other menu items is highlighted, that is, displayed in black lettering on an amber background. Figures 2-6, 2-7, and 2-8 show these three menus and indicate the highlighting on the associated displays.

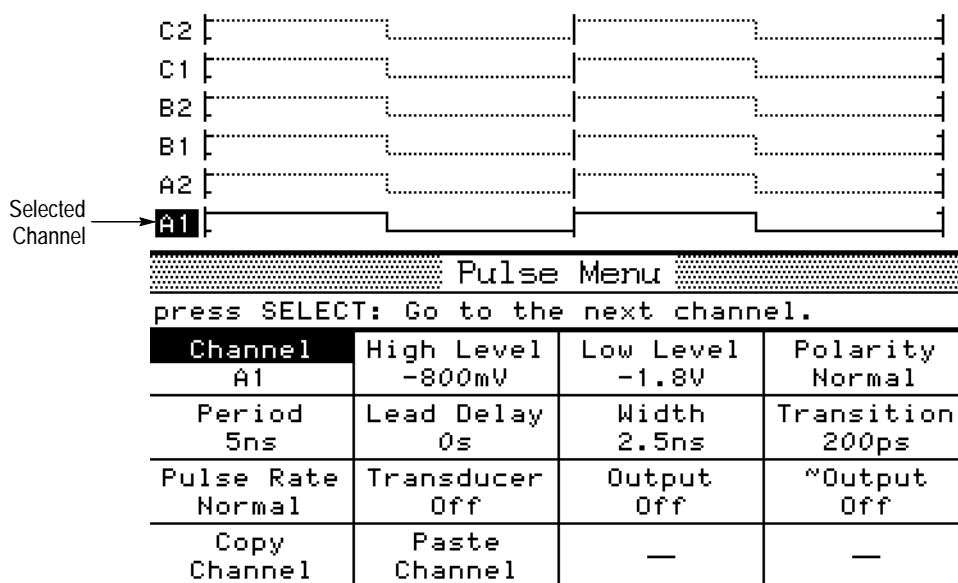

Figure 2-6: Pulse Menu, Showing Channel Selection

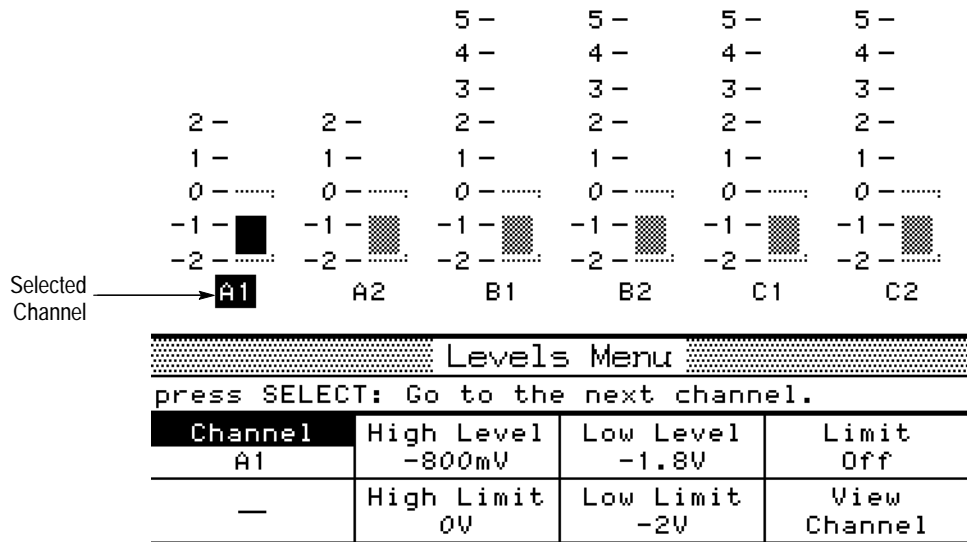

Figure 2-7: Levels Menu, Showing Channel Selection

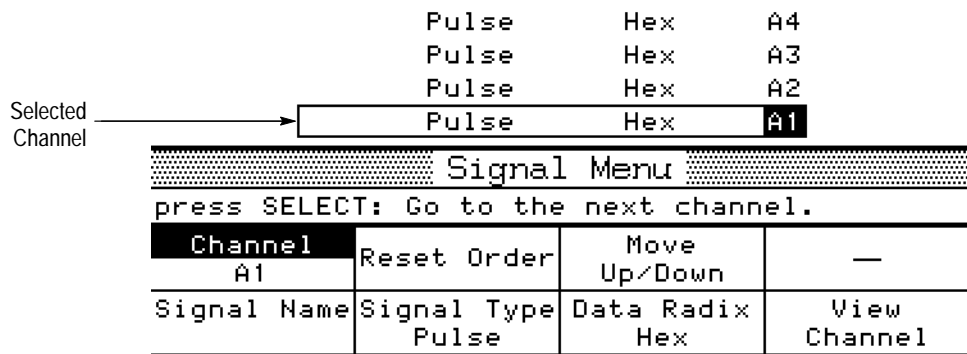

Figure 2-8: Signal Menu, Showing Channel Selection



# Data Time Generators

The HFS 9DG1 and HFS 9DG2 Data Time Generators combine the capabilities of a data time generator, pulse generator, and switch matrix in a single instrument. As part of the HFS 9000 Stimulus System, the data time generator can deliver complete data and timing signals to the circuit under test. Within the data time generator, every output is capable of producing any type of data and formatting — not just data and pulses. Complete control over rise and fall times, widths, and voltage levels on all data is provided. Because of their unique digital architecture, the data time generators can place an edge anywhere, even delaying waveforms across cycle boundaries.

Controls for the data time generators are accessed in several menus. Controls that affect the pulse parameters of the data time generators are in the Pulse menu, as shown in Figure 2–9. For more information on pulse parameter controls, see page 2–45.

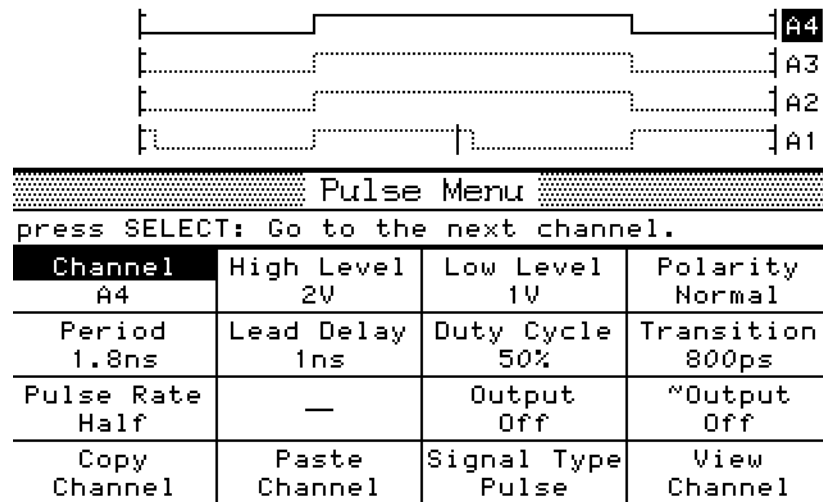

Figure 2–9: The Pulse Menu

Menus that control data generation parameters are the Signal menu, the Data Fill menu, the Data Copy menu, and the Data Edit menu.

## Turning Channels On and Off

The HFS 9DG1 provides two output connectors for each channel. Channels are identified by number; they are labeled **CH 1** through **CH 4**. Each channel provides both normal and logically inverted output and are labeled **OUTPUT** and **OUTPUT**. The HFS 9DG2 provides one output connector for each channel, labeled **CH 1** through **CH 4**.

Each output connector has a button to turn that output on or off, and a light showing whether or not that output is on. You can also turn on or off the normal or inverted output of any channel using the Pulse menu items **Output** and **~Output**.

## Naming a Channel

Generally, a channel is referred to by its slot and channel number; for example, you would refer to channel 1 of the card in slot A as channel A1. Additionally, you can identify a channel with a name. This would enable you to identify the signal going to the Write Enable pin of the DUT (device under test) as “WE” rather than A1. Any channel on any card can be given a name; this feature is not limited to the data time generator cards.

Assigning a name to a channel is performed by the **Signal Name** item in the Signal menu (see Figure 2–10).

	NRZ	Hex	A4
	NRZ	Hex	A3
	NRZ	Hex	A2
	NRZ	Hex	<b>A1</b>
Signal Menu			
press SELECT to edit this label.			
Channel	Reset Order	Move	—
A1		Up/Down	
<b>Signal Name</b>	Signal Type	Data Radix	View
	NRZ	Hex	Channel

Figure 2–10: The Signal Menu

To assign a name to a channel, select the channel using the **Channel** menu item. Select the **Signal Name** menu item and press **SELECT**. The dialog box appears as in Figure 2–11.

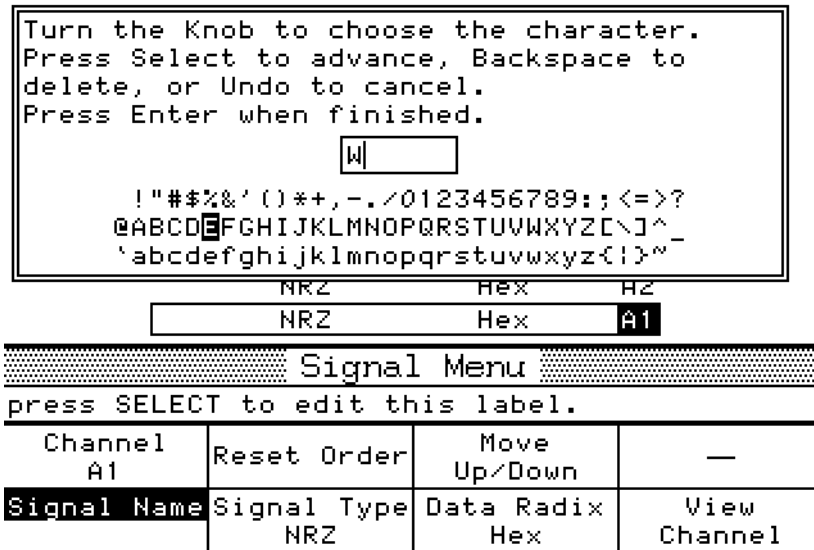

Figure 2-11: The Signal Name Dialog Box

To enter a name, choose a character by turning the knob or pressing the arrow keys. When the character is highlighted, press **SELECT** to signify your selection and enable selection of the next character. A signal name can be up to six characters long. When you are finished selecting characters, press **ENTER**. The dialog box will disappear and the new signal name will appear in the **Signal Name** and **Channel** menu items (see Figure 2-12).

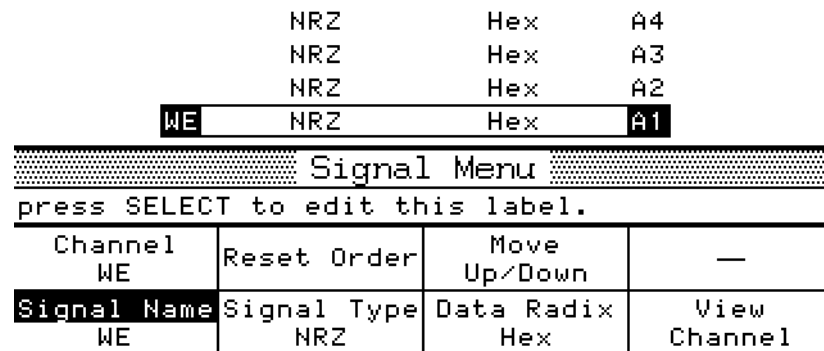

Figure 2-12: Signal Menu After Entering Signal Name

You can also name buses. To do this, assign the same name to two or more channels, but use different numbers as the last character in the name. You could create an bus named “ADDRx”, where x represents the number of each line of the bus (see Figure 2–13).

ADDR3	NRZ	Hex	A4
ADDR2	NRZ	Hex	A3
ADDR1	NRZ	Hex	A2
ADDR0	NRZ	Hex	A1

Signal Menu			
press SELECT to edit this label.			
Channel ADDR3	Reset Order	Move Up/Down	—
Signal Name	Signal Type	Data Radix	View
ADDR3	NRZ	Hex	Channel

Figure 2–13: Naming a Bus

If you create a bus, you can choose to view the bus by individual channel or as a single entity that represents the whole group. You change the view of channels with the **View** item. You can choose to view channels as a Channel or as a Group. In this manual, we will use “Signal” to refer to a channel that has been named. Figure 2–14 below is the same display as above except that the View is set to Group.

Addr[]	NRZ	Hex	A1
--------	-----	-----	----

Signal Menu			
press SELECT: Channel▶Group			
Channel Addr[]	Reset Order	Move Up/Down	—
Signal Name	Signal Type	Data Radix	View
Addr[]	NRZ	Hex	Group

Figure 2–14: Viewing a Bus by Group

## Signal Type

A Signal on an HFS 9DG1 or HFS 9DG2 can be of five different types: Pulse, NRZ (Non-Return to Zero), RZ (Return to Zero), R1 (Return to One), and DC. The signal type is assigned with the **Signal Type** menu item (see Figure 2–15).

	NRZ	Hex	A4
	NRZ	Hex	A3
	NRZ	Hex	A2
<b>WE</b>	NRZ	Hex	<b>A1</b>
Signal Menu			
press SELECT: Pulse▶NRZ RZ R1 DC Transducer			
Channel	Reset Order	Move Up/Down	—
WE			
Signal Name	Signal Type	Data Radix	View Channel
WE	NRZ	Hex	Channel

Figure 2-15: Assigning Signal Type

To set the signal type, select the channel using the Channel menu item. Select the **Signal Type** menu item. Turn the knob to select the correct signal type (the **Transducer** signal type appears in the menu but it cannot be assigned to data time generator channels).

## Changing Display Order

You can change the order in which signals are displayed using the **Move Up/Down** and **Reset Order** menu items in the Signal menu. To change the display order of signals, select the channel you want to move with the **Channel** menu item. After selecting the channel you want to move, select the **Move Up/Down** menu item (see Figure 2-16). To move the channel to a different position in the display order, turn the knob.

↑	<b>ADDR3</b>	NRZ	Hex	<b>A4</b>
	ADDR2	NRZ	Hex	A3
	ADDR1	NRZ	Hex	A2
	ADDR0	NRZ	Hex	A1
Signal Menu				
Turn the Knob to move this channel.				
Channel	Reset Order	Move Up/Down	—	
ADDR3				
Signal Name	Signal Type	Data Radix	View Channel	
ADDR3	NRZ	Hex	Channel	

Figure 2-16: Changing the Display Order

If you wish to return the display order to the default order (A1, A2, A3, A4, B1, B2, etc.), select the **Reset Order** menu item and press **SELECT**. A dialog box

will appear asking you to confirm that you wish to reset the channel order. The default answer is **Yes**. To select **Cancel**, use either the knob or the up/down arrow keys to change the selection. When the correct response is highlighted, press **SELECT**.

## Entering Vector Data

Data can be entered in three ways. One way is to enter data one bit at a time using the Data Edit menu. Another way is to use the Data Fill and Data Copy menus. The third method is used if you have generated test vectors with a CAD system or Tektronix BitWriter™ Software. With this method, you transfer your vector data into the HFS 9000 via the programming interface. For more information on entering data via the programming interface, please refer to page 3–121.

### Editing Vectors

You view and edit the contents of vectors from the Data Edit menu. There are no menu items in the Data Edit menu. To display the Data Edit menu, select **Data Edit Menu** from the main menu (see Figure 2–17).

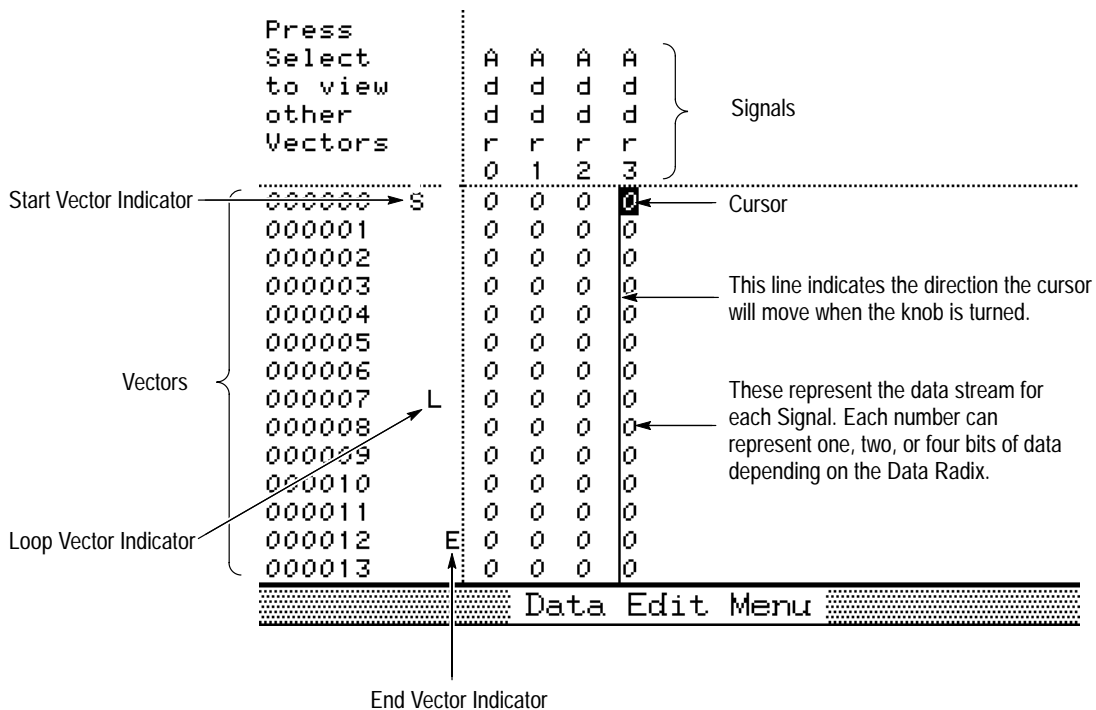

Figure 2–17: The Data Edit Menu

To edit the contents of a vector, move the cursor using the knob or the arrow keys. When the appropriate datum is highlighted, type the change using the keypad. When you type the change, the highlighted datum is changed and the cursor moves to the next datum. Note that the number of bits each datum represents depends on the Data Radix setting.

## Vector Parameters

There are several parameters related to vectors; these parameters are accessed from the Vector menu. From the Vector menu, you can set the Start, Loop, and End addresses. The vector radix, data radix, and time base mode are also set in this menu (see Figure 2–18).

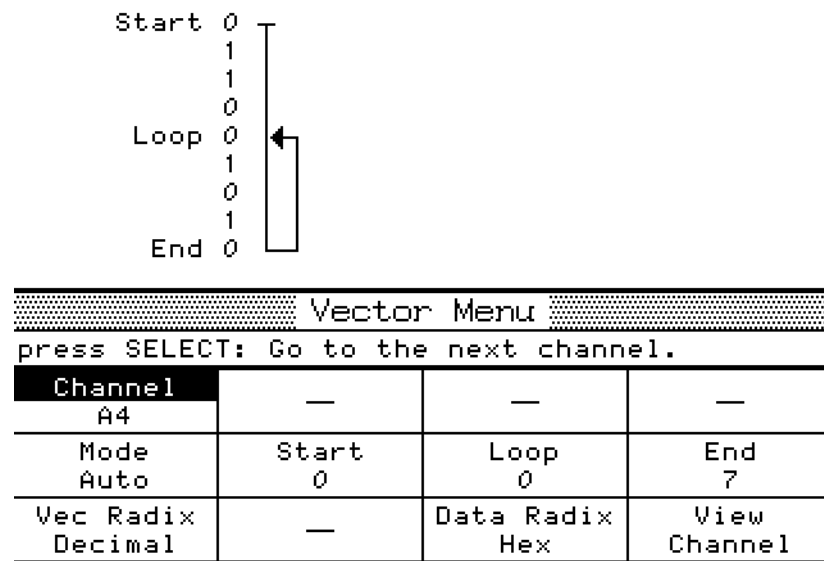

Figure 2–18: The Vector Menu

To set vector parameters, select the channel whose parameters you wish to set using the **Channel** menu item. Next, select the parameter you wish to set and use the knob (or numeric keypad as appropriate) to change the value.

- **Start** sets the vector of the first data bit output.
- **Loop** sets the start vector of all cycles except the first. The Loop value is used only in Auto and Trig Auto modes; it is ignored in Burst and Auto Burst modes. Loop is useful if you need to send setup information with the first cycle of data, but don't want it to be sent out on subsequent cycles. Of course, Loop can be set to the same vector as Start.

There are some constraints on Loop size (defined as:  $\text{End} - \text{Loop} + 1$ ). If vector consumption (defined as:  $\text{End} - \text{Start} + 1$ ) is:

≤8192, there are no constraints on Loop size

> 8192, then Loop size must be divisible by 2

>16384, then Loop size must be divisible by 4

>32768, then Loop size must be divisible by 8

- **End** sets the vector of the last data bit output.

---

***NOTE.** Start, Loop, End, Mode, and Vec Radix are global values. If you change these settings for any channel, the change applies to all channels.*

---

- The **Mode** menu item determines how data is output from the data time generator. It is the same as the **Mode** menu item in the Time Base Menu.

In **Burst** mode, the HFS 9000 waits for a trigger event at the **TRIGGER IN** connector, a remote \*TRG command, or a press of the **MANUAL TRIGGER** button. When a trigger event is detected, the HFS 9000 waits for approximately 130 ns (the startup delay) before outputting data. Data output begins with the Start vector and stops with the End vector. The HFS 9000 then awaits the next trigger event.

In **Auto-Burst** mode, output is similar to Burst, except that the HFS 9000 creates its own trigger events. There is a delay of approximately 15 μs between bursts.

- In **Auto** mode, data is output continuously without waiting for trigger events and without any startup events. Data output begins with the Start vector. Once End is reached, the output begins again at Start (or Loop if it is different from Start) and continues until stopped by a knob turn or ASCII interface command (RS-232-C or GPIB).

In **Trig-Auto**, the output is the same as with Auto mode, but output does not begin until a trigger event is received. The HFS 9000 waits for a trigger event at the **TRIGGER IN** connector, a remote \*TRG command, or a press of the **MANUAL TRIGGER** button.

If data output is stopped when **Mode** is set to Auto or Trig Auto, note that all channels may not stop on the same vector. Additionally, if a signal is set to NRZ and filled with “1”s as data, the channel may stop in a “0” state.

- **Vec Radix** specifies how vectors are displayed.
- **Data Radix** specifies how data is displayed in the Vector Edit menu. Data Radix applies only to the selected channel.

## Filling Vectors with Data

To quickly fill vectors with data, use the Data Fill menu (see Figure 2–19). The underlying concept used in the Data Fill menu is the idea of a Block. A Block is



a group of vectors. You specify a Block using a starting vector and either an ending vector or a block size. Once a Block is appropriately specified, you either fill the block with data or clear the block of data.

A Block is filled using the **Fill Block with Method** menu item. The three parameters for **Fill Block with Method** are **Constant**, **Method**, and **Fill Scale**.

```
Invert a block of Addr[].
```

Data Fill Menu			
press SELECT: Go to the next channel.			
Channel Addr[]	Block Start 0	Block End 12	Clear Block
Constant 1	Method Invert	Fill Scale 1	Fill Block with Method
Vec Radix Decimal	—	Data Radix Hex	View Group

Figure 2–19: The Data Fill Menu

- **Channel** selects the Signal (named channel) or bus on which the **Fill Block with Method** and **Clear Block** commands operate.
- **Block Start** sets the vector where fill or clear operations begin. Turn the knob or use the numeric keypad to change the Block Start vector.
- **Block End** sets the last vector in the Block. Turn the knob or use the numeric keypad to change the Block End vector. Pressing **SELECT** while Block End is highlighted changes the menu item to Block Size.

Block Size provides a second method of defining a block. Block Size sets the size of the block, regardless of the Block Start vector.

- **Clear Block** sets all the bits in the Block to zero. Note that if View is set to channel, only the selected channel is cleared. If View is set to Group, all channels in the specified bus are cleared.
- **Constant** is a number used by the **Method** menu item. Depending on the fill method selected, the constant is the number used to fill a Block or a

parameter used when filling a block. Note that valid numbers for Constant depend on the Data Radix setting. To change the constant, turn the knob or use the numeric keypad.

- **Method** specifies the algorithm used to fill a Block with data.

**Constant** fills the Block with the value in the **Constant** menu item.

**Invert** logically inverts the value of all the data in the Block.

**Count Up** fills each vector in the Block with an incrementally larger value. Count Up starts with the value specified by the **Constant** menu item.

**Count Down** fills each vector in the Block with an incrementally smaller value. Count Down starts with the value specified by the **Constant** menu item.

**Random** fills vectors in the Block with a pseudo-random data pattern. The pattern generated is based on the value of Constant.

- **Fill Scale** is a multiplier. It sets the number of vectors that receive each fill pattern. For example, if the fill method is set to Count Up and Constant is set to 0, then the Start vector is filled with a 0, the next vector receives a 1, the next vector receives a 2, etc. If Fill Scale is set to 3, then the Start vector and the next two vectors receive 0s, the next three vectors receive 1s, etc. Figures 2–20 and 2–21 show the result of setting Fill Scale to 1 and to 3.

Press		A	
Select		d	
to view		r	
other		E	
Vectors		J	
000000	S	0 0 0 0	Fill Scale was set to 1 when this block was filled. Thus, every vector receives a different value.
000001		0 0 0 1	
000002		0 0 1 0	
000003		0 0 1 1	
000004	L	0 1 0 0	
000005		0 1 0 1	
000006		0 1 1 0	
000007		0 1 1 1	
000008		1 0 0 0	
000009		1 0 0 1	
000010	E	1 0 1 0	
000011		1 0 1 1	
000012		1 1 0 0	
000013		1 1 0 1	

Data Edit Menu

Figure 2–20: A Block Filled with Fill Scale Set to 1

```

Press          A
Select        d
to view       d
other         r
Vectors       C
              J
-----
000000  S    0 0 0 0
000001          0 0 0 0
000002          0 0 0 0
000003          0 0 0 1
000004  L    0 0 0 1
000005          0 0 0 1
000006          0 0 1 0
000007          0 0 1 0
000008          0 0 1 0
000009          0 0 1 1
000010  E    0 0 1 1
000011          0 0 1 1
000012          0 1 0 0
000013          0 1 0 0
-----
Data Edit Menu

```

Fill Scale was set to 3 when this block was filled.  
Thus, each group of 3 vectors receives the same value.

Figure 2–21: A Block Filled with Fill Scale Set to 3

- Selecting **Fill Block with Method** fills the Block using the parameters set in **Constant**, **Method**, and **Fill Scale**.

### Copying Vector Data

You can also copy data in one Block to another using the **Data Copy Menu** (see Figure 2–22). The Data Copy menu provides the capability to copy a block of data from one channel to another or to duplicate a block of data within the same channel. You can also swap blocks of data between channels or within the same channel.

Aside from copying blocks of data, the **Data Copy Menu** can be used to insert a new vector into a Block. To insert a new vector into a Block, just copy the Block to a Dest Start vector one higher than the new vector. For example, if you need to insert a new vector at 000010, copy the vectors from 000010 through the end of the Block to a Dest Start address of 000011 (1 higher than 000010). Then edit the new vector in the Data Edit menu. You can delete single vectors using the same method — set the Dest Start vector to one less than the vector to be removed.

Copy will affect  
Addr0 vectors 13 through 25.

Data Copy Menu			
press SELECT to copy the block.			
Channel Addr0	Block Start 0	Block End 12	Copies 1
Dest Chan Addr0	Dest Start 13	Swap Block with Dest	Copy Block to Dest
Vec Radix Decimal	—	—	View Channel

Figure 2–22: The Data Copy Menu

- **Channel** selects the Signal (named channel) or bus on which the **Copy Block to Dest** and **Swap Block with Dest** commands operate.
  - **Block Start** sets the vector where copy or swap operations begin. Turn the knob or use the numeric keypad to change the Block Start vector.
  - **Block End** sets the last vector in the Block. Turn the knob or use the numeric keypad to change the Block End vector. Pressing **SELECT** while Block End is highlighted changes the menu item to Block Size.
- Block Size** provides a second method of defining a block. Block Size sets the size of the block, regardless of the Block Start vector.
- **Copies** sets the number of times the Block is copied.
  - **Dest Chan** specifies the channel that will receive the copied Block.
  - **Dest Start** sets the vector where the copied Block will begin.
  - **Swap Block with Dest** swaps the Block defined by Block Start and Block End/Size with the Block that begins at Dest Start.
  - **Copy Block to Dest** copies the Block defined by Block Start and Block End/Size to the Block that begins at Dest Start.
  - **Vec Radix** specifies how vectors are displayed in the Vector Edit menu.
  - **View** sets the display mode to either Channel or Group.

# Deskew

You can adjust two parameters to deskew the HFS 9000 so that its timing matches the external circuitry you are working with. Both these parameters, **Pretrigger** and **Chan Delay**, are in the Cal/Deskew menu as shown in Figure 2–23.

---

***NOTE.** Channel delay is set for each channel individually, while Pretrigger affects all channels by changing the delay relative to the HFS 9000 output trigger.*

---

Cal/Deskew Menu			
press SELECT to view the configuration.			
View Config	Self Test	Calibrate	—
Pretrigger 70ns	Channel A1	Chan Delay 0s	—

Figure 2–23: The Cal/Deskew Menu

## Channel Delay

You can set **Chan Delay** (channel delay) independently for each channel (Figure 2–24 shows the result of deskewing one channel). Channel delay adjusts the time between the trigger out the detection of a trigger event at the **TRIGGER IN** connector and the beginning of the first pulse window of the burst. There is normally a delay of approximately 130 ns between these two events. Channel delay lets you adjust the delay for each channel from –60 ns to 2  $\mu$ s. This value is added to the 100 ns internal delay.

In the Cal/Deskew menu, the **Channel** menu item lets you set which channel the **Chan Delay** menu item controls. Use the **SELECT** button or the knob to select the channel. Once you have set the desired channel, you can set the channel delay for that channel. An alternate method of channel selection is to use the **NEXT CHANNEL** and **PREVIOUS CHANNEL** buttons next to the display.

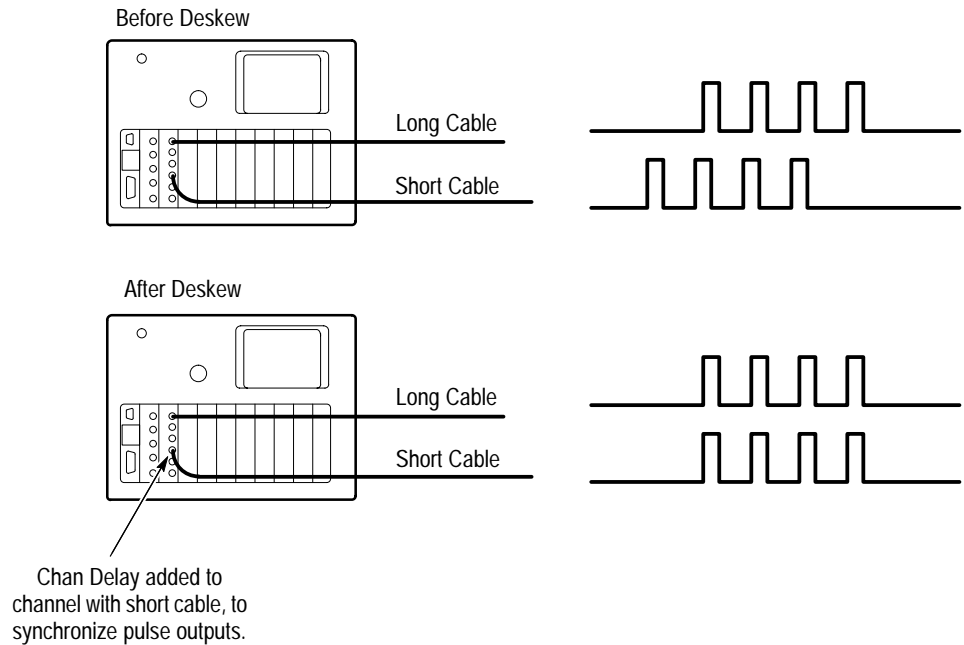

**Figure 2-24: Deskewing Channels**

Follow this sequence to deskew several channels so that they deliver pulses simultaneously to your device under test:

1. Connect the generator channels to the device under test using the exact cabling that you will use in the actual testing.
2. Set the **Chan Delay** of each channel to zero.
3. Turn on pulse output for each channel you are using. On each channel, set the **Lead Delay** to zero or the **Phase** to 0%. Set the **Count** to 1.
4. Using an oscilloscope, measure the time between the trigger event on the trigger signal and the rising edge of the pulse of each channel. Note which channel has the longest time delay; this is the reference channel.
5. For each channel in turn, adjust the **Chan Delay** until the time between the trigger event and the rising edge of the channel pulse matches that of the reference channel.

You can do this arithmetically, by computing the time difference and setting **Chan Delay** to that value. Alternately, you can do this using the oscilloscope, by probing each channel *with the same oscilloscope probe* and adjusting the **Chan Delay** until the pulse timing matches the reference channel.

This procedure synchronizes the channels so that they all deliver pulses to the device under test simultaneously. The procedure compensates for timing differences in the electrical paths of the channels, for example those caused by unequal cable lengths.

Once you have deskewed the channels, you can introduce controlled timing variations by using the **Lead Delay** or **Phase** menu items.

## Trigger Out Pretrigger

The output trigger can be adjusted to occur before the beginning of the specified pulse window. The default setting of 70 ns means that the trigger out signal appears 70 ns before the beginning of the pulse window.

Pretrigger can be used to compensate for the delay times incurred by cabling between the **TRIGGER OUT** connector and the device to be triggered. Pretrigger is also useful to compensate for an oscilloscope insertion delay; for example, the typical insertion delay for the Tektronix CSA 803 is approximately 35 ns.





# GPIB

You can use the GPIB (IEEE 488.2-1987) interface to control the HFS 9000 from a remote controller or computer. The Reference section of this manual, gives you step-by-step details of how to set up the HFS 9000 for remote operation. The following information describes the settings and controls that affect GPIB operation.

Connect your HFS 9000 to the GPIB using an IEEE STD 488 GPIB cable (available as Tektronix part number 012-0991-00). Figure 2-25 shows the location of the **GPIB** connector on the front of the HFS 9000.

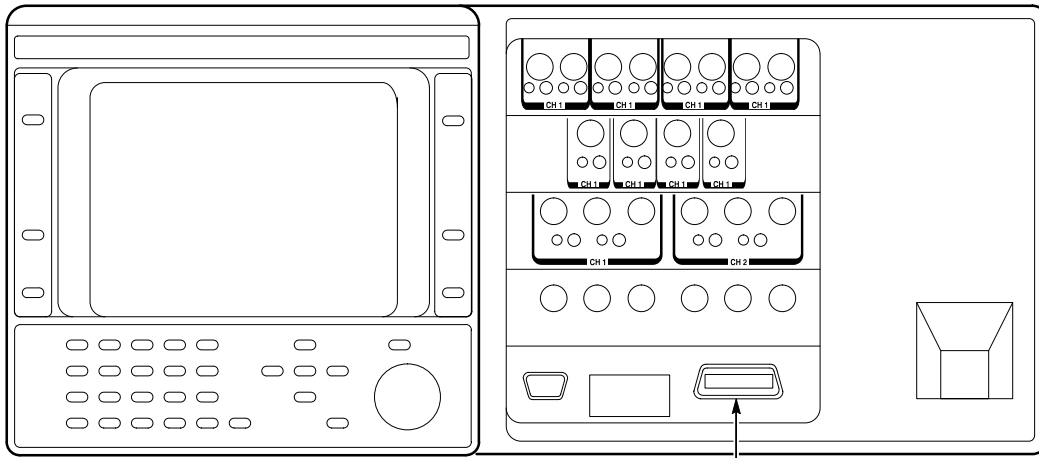

GPIB Connector

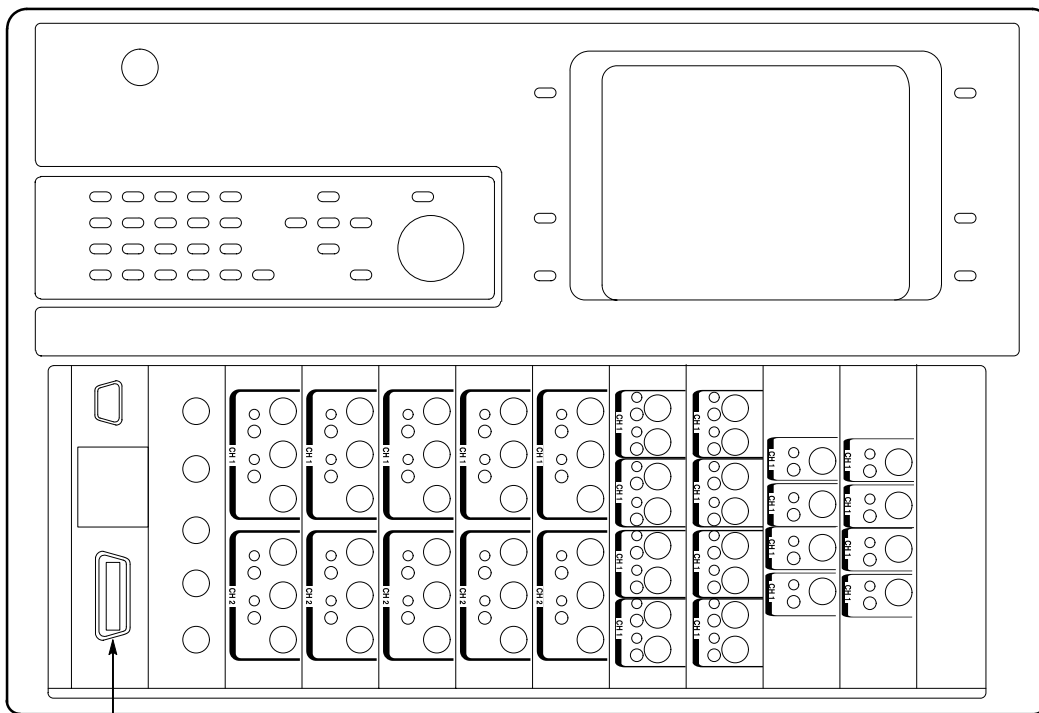

GPIB Connector

Figure 2-25: GPIB Connector Location

## Operator Controls

One common application for the HFS 9000 is as one instrument in a suite of automated test equipment. In this environment, the controlling program may need to operate the HFS 9000 for extended periods without operator intervention. The program may need to stop to have the operator perform some specific action. The program then needs to have some indication from the operator that the operator action has been completed and the program can continue the suite of tests.

The HFS 9000 supports this environment in two ways:

- The front-panel interface of the HFS 9000 can be locked out (disabled) and unlocked using commands sent from a remote controller or computer. When the front panel is locked out, the **REMOTE** light at the left of the display is lit. However, the **SRQ** button and the channel buttons on the pulse generator cards cannot be locked out. These buttons are always operational regardless of the state of lockout.
- The operator can send a trigger to the controlling program by pressing the **SRQ** button, just below the **REMOTE** light (see Figure 2–26).

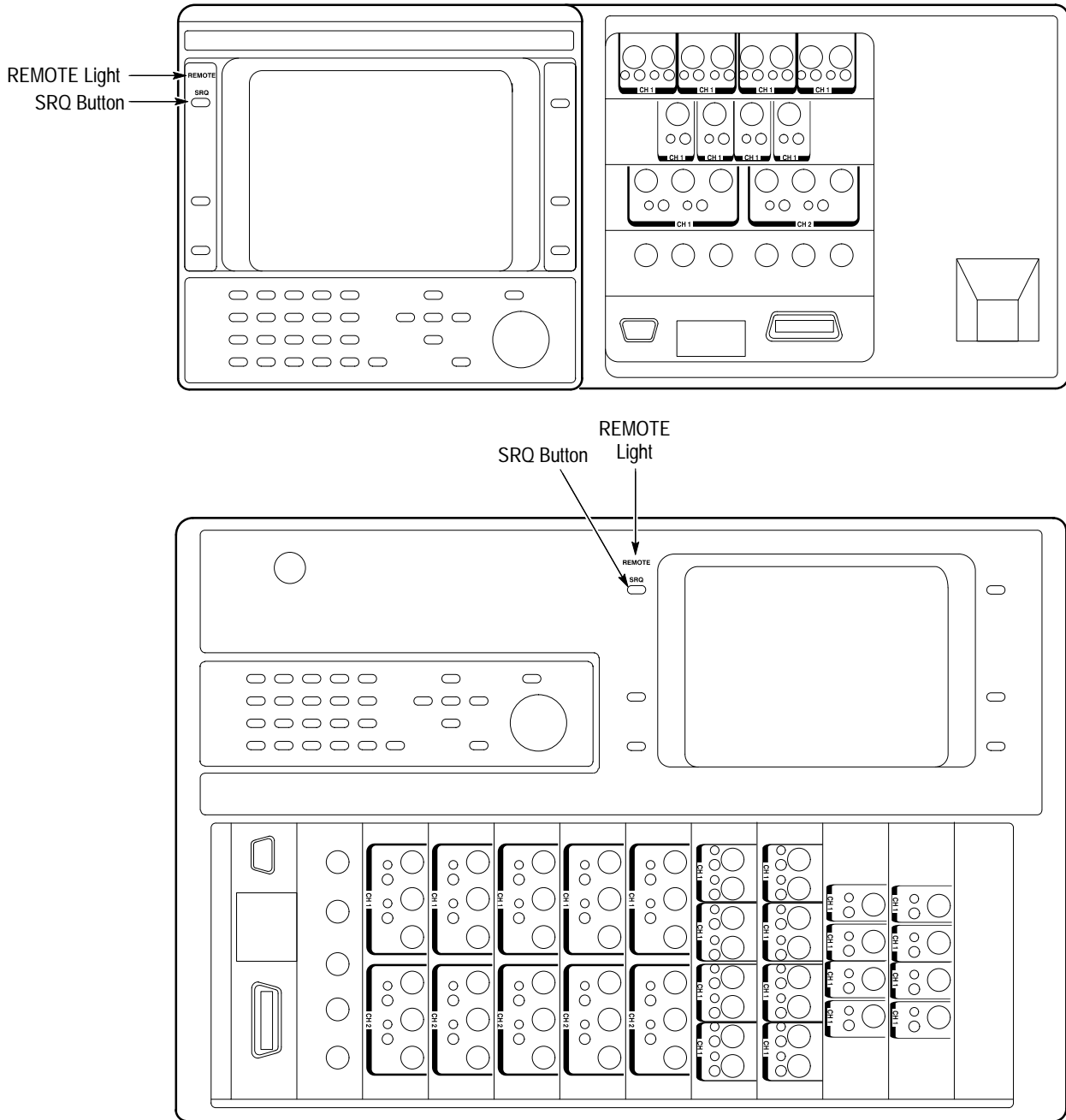

Figure 2-26: SRQ Button and REMOTE Light Locations

When the program expects the operator to perform some action before it can continue, it unlocks the front panel interface and displays a message to prompt the operator. The operator then performs the necessary action, after which he or she presses the **SRQ** button. The program recognizes the button press, locks out the front panel, and continues to the next automated test.

## The GPIB Menu

GPIB Menu			
Address	On Bus	—	Debug
1	On	—	Off

Figure 2-27: The GPIB Menu

*NOTE. The settings of the GPIB parameters are not changed when you reset or factory reset the HFS 9000 or when you recall settings.*

- **Address** lets you set the device address of the HFS 9000 (see Figure 2-27). Valid device addresses are 0 through 30. Once the device address is set, all other devices will communicate with the HFS 9000 using its device address. Every device on a GPIB bus must have a unique device address.
- **On Bus** lets you “turn off” or “turn on” the GPIB interface. When set to Off, the HFS 9000 GPIB interface is disabled and the remaining devices on the bus operate as if the HFS 9000 were not connected to the bus.
- **Debug** specifies whether commands and control settings appear in the HFS 9000 display. When debug is on, a display window appears showing the most recent commands sent to the HFS 9000, and the status of several control settings. Appendix C, Interface Specifications, gives complete information about using debug mode.



# Levels

You can set the voltage levels that the HFS 9000 uses for logical high and logical low. You can also limit the voltage levels that can be set with the normal level controls. Voltage level and level limit controls are provided for each channel individually. The output voltage range varies between cards as shown in Table 2–1.

**Table 2–1: Output Voltage Limits**

Pulse/Data Time Generator	Minimum Low Level	Maximum High Level
HFS 9PG1	–2 V	+2.6 V
HFS 9PG2	–2 V	+5.5 V
HFS 9DG1	–2.5 V	+5.0 V
HFS 9DG2	–2.0 V	+5.5 V

When you turn level limit on, the voltage level settings for each channel are adjusted, if necessary, to be within the limit boundaries set for that channel.

---

***NOTE.** Turning limiting off does not restore the channel voltage levels to their previous, unlimited values.*

---

## Setting Voltage Levels

The controls for levels are located in the Pulse Menu (see Figure 2–28) or the Levels Menu (see Figure 2–29).

Pulse Menu			
press SELECT: Go to the next channel.			
Channel	High Level	Low Level	Polarity
A1	-800mV	-1.8V	Normal
Period	Lead Delay	Duty Cycle	Transition
5ns	0s	50%	800ps
Pulse Rate	—	Output	Output
Normal		Off	Off
Copy Channel	Paste Channel	Signal Type	View Channel
		Pulse	

Figure 2–28: The Pulse Menu

The Pulse menu has these level controls:

- **Channel** lets you set the channel that the other menu items control. Use the **SELECT** button, the knob, or the **PREVIOUS CHANNEL** and **NEXT CHANNEL** buttons to select channels.
- **High Level** and **Low Level** are the voltage levels used for logical high and low. These can be set by knob or entered by keypad. If limiting is on, you will not be able to extend the voltages beyond the limits.

You can use the **SELECT** button to change **High Level** and **Low Level** into **Amplitude** and **Offset**. Amplitude is the voltage difference between the levels. Offset is the voltage level assigned to the midpoint between the levels.

## Setting Level Limits

The controls for level limits are located in the Levels Menu (see Figure 2–29). Controls for voltage levels are also provided here. The associated display graphically shows the levels and limits for each channel.



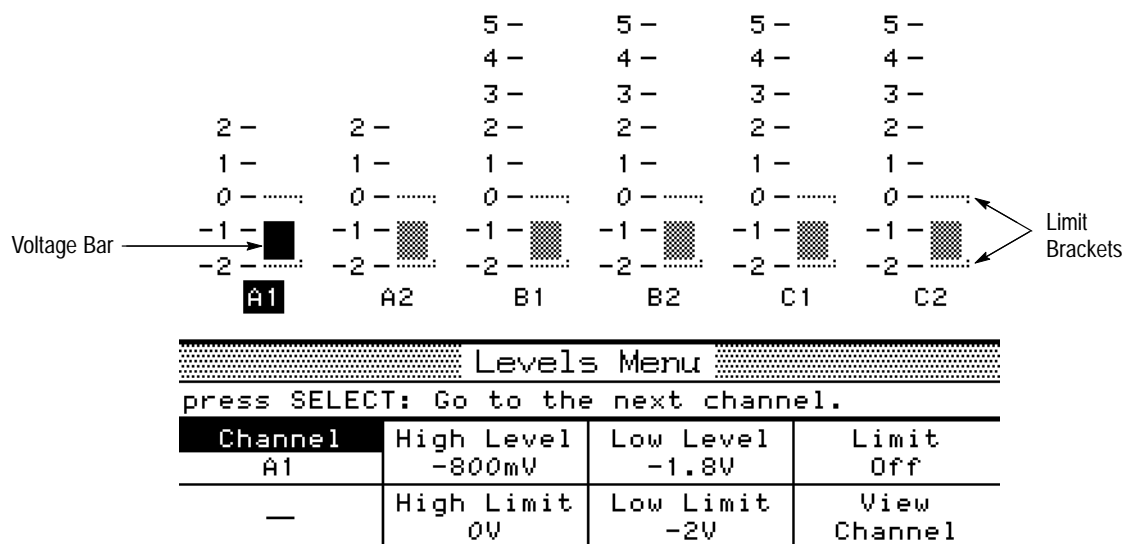

Figure 2-29: The Levels Menu and Associated Display

The Levels menu has these controls:

- **Channel** lets you set the channel that the other menu items control. Use the **SELECT** button, the knob, or the **PREVIOUS CHANNEL** and **NEXT CHANNEL** buttons to select channels.

The currently selected channel is indicated in the associated level display by having a denser level bar and having a highlighted channel name. The currently selected channel is also shown in the **Channel** menu item.

- **High Level** and **Low Level** are the voltage levels used for logical high and low. These are the same controls provided in the Pulse menu. They can be set by knob or entered by keypad. As you change these values, the voltage bar in the associated display changes to match. If limiting is on, you will not be able to extend the voltage bar beyond the limit brackets.

You can use the **SELECT** button to change **High Level** and **Low Level** into **Amplitude** and **Offset**. Amplitude is the voltage difference between the levels. Offset is the voltage level assigned to the midpoint of the amplitude range.

- **High Limit** and **Low Limit** are the voltage limits to use when limiting is on. These can be set by knob or entered by keypad. As you change these values, the limit brackets in the associated display change to match. If limiting is on, moving a bracket into the voltage bar will cause the bar to shrink.

- **Limit** sets limiting on or off. When limiting is on, any voltage levels that are outside the limits are reset to their respective limits. Limiting also adjusts voltage levels values as you change the limits.

Turning limiting off does not restore the channel voltage levels to their previous, unlimited, values.

# Phase Lock

You can synchronize and lock the HFS 9000 to an external timing source connected to the **PHASE LOCK IN** connector. This timing source then replaces the HFS 9000 internal clock. You can run the HFS 9000 at frequencies that are power-of-two harmonics or sub-harmonics of the phase lock signal. For example, you could run the HFS 9000 at  $1/16^{\text{th}}$  the phase lock frequency or at 32 times the phase lock frequency.

When in phase lock mode, you can use an external signal connected to the **FRAME SYNC IN** connector to provide a phase-locked trigger.

## Establishing Phase Lock

The signal connected to **PHASE LOCK IN** must be stable and continuous. It must not change frequency once phase lock is established. The frequency range of the phase lock signal must be between 6 MHz and 630 MHz.

The **PHASE LOCK IN** signal must have a voltage between 0.8 V and 1.0 V peak to peak. The input circuitry removes the DC component by passing the signal through a 0.1  $\mu\text{F}$  blocking capacitor. The signal is then terminated by a 50  $\Omega$  resistor to ground.

To ensure the proper operation of phase lock, it is important to calibrate the HFS 9000 after the instrument has been repaired or after the instrument has been reconfigured by adding or changing cards. It is also necessary to calibrate the HFS 9000 if you operate the instrument in an environment where the ambient temperature differs by more than 5° C from the temperature of the last calibration. As a matter of routine, you should calibrate the HFS 9000 every six months. Refer to page 2–7 for details about calibrating the HFS 9000.

Use the following procedure to establish phase lock and to put the HFS 9000 in phase lock mode:

1. Connect the phase lock signal to the **PHASE LOCK IN** connector on the Time Base Card (see Figure 2–30).

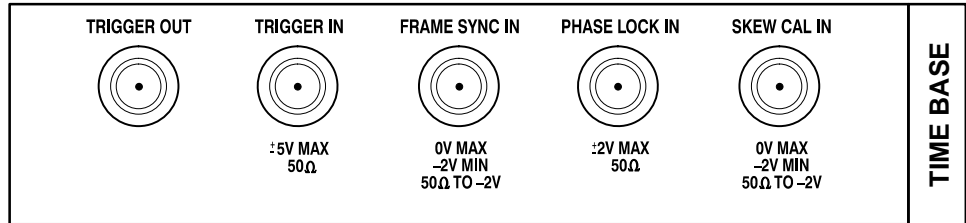

Figure 2-30: The Time Base Card Connectors

- Use the **PhaseLockIn** item in the Time Base menu to set phase lock to **On**. Figure 2-31 shows the Time Base menu with the detected phase lock frequency above the menu.

**NOTE.** If the HFS 9000 cannot determine the phase lock frequency, an error message is displayed. This will happen if the phase lock signal is not stable and continuous, or if the phase lock signal is outside the allowed frequency range, or if the HFS 9000 needs calibrating.

```
PhaselockIn = 250.000MHz
Time Base Menu
press SELECT: Off ▶ On
```

Mode Burst	Frequency 500MHz	Count 64	Out Period 1
Trigger In On	Trig Slope Positive	Trig Level -1.3V	<b>PhaseLockIn On</b>

Figure 2-31: The Time Base Menu with the PhaseLockIn Menu Item

**NOTE.** If you need to change the frequency of the phase lock signal after phase lock mode is established, turn phase lock mode off, then establish the new stable frequency before turning on phase lock mode again.

## Setting Period or Frequency During Phase Lock

When phase lock is first established, the setting of the **Period** or **Frequency** menu items changes to reflect the period or frequency of the phase lock signal.

You can change the frequency or period while in phase lock, but only by powers of two; that is, you can repeatedly double or halve the period or frequency. If you adjust period or frequency with the knob, each knob click will double or halve the value in the menu item. The frequencies you can use are limited to those within the frequency specifications of the HFS 9000.

## Triggering During Phase Lock Mode

You can provide a triggering window while in phase lock mode. This triggering window is the time during which the input at the **FRAME SYNC IN** connector is held high. A trigger event is the first positive-going edge of the phase lock signal that occurs during the triggering window (see Figure 2–32).

The **FRAME SYNC IN** is terminated through  $50\ \Omega$  to  $-2.0\ \text{V}$ . Logical low is from  $-1.810\ \text{V}$  to  $-1.475\ \text{V}$ ; logical high is from  $-1.165\ \text{V}$  to  $-0.810\ \text{V}$ . These are standard ECL specifications.

Just as normal triggering (a trigger event at the **TRIGGER IN** connector) is only operational during Burst mode operation, phase lock triggering using the **FRAME SYNC IN** connector can only be used during Burst mode. (See page 2–61 for a description of Burst, Auto-Burst, Auto, and Trig-Auto modes.)

Phase lock triggering is disabled when the **Trigger In** item in the Time Base menu is **Off**.

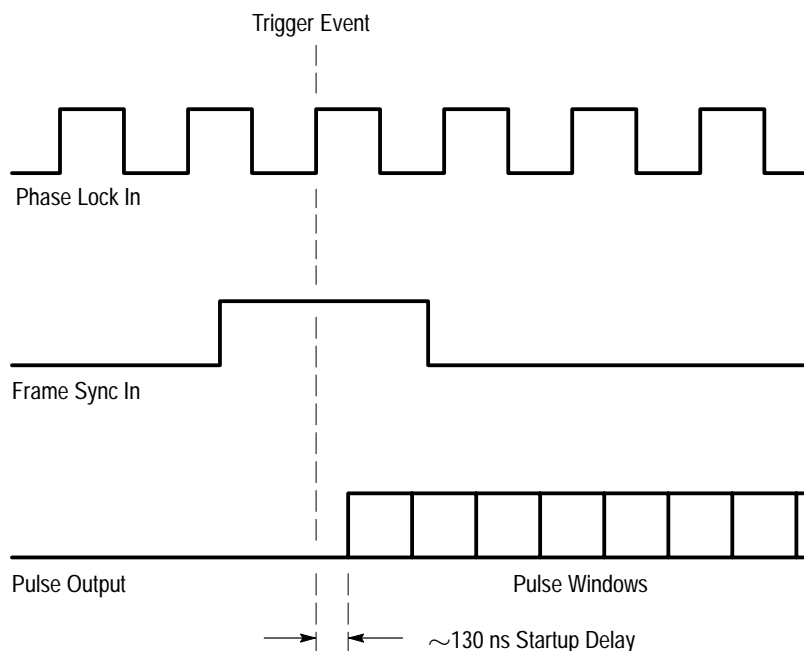

Figure 2–32: Phase Lock In and Frame Sync In Timing Relationships

## Phase Lock After Power on or Recall

Phase lock is set to off whenever you power on the HFS 9000 or whenever you recall a setting. This is because a signal must be applied to the **PHASE LOCK IN** connector before phase lock is established. Once you have recalled a setting or powered on, you can connect your phase lock signal and then turn on phase lock mode.

## Power On

When you power on the HFS 9000, it runs the self test diagnostics. Then it restores the instrument setting to the same way it was the last time it was powered off with the exception of the following two conditions:

- All outputs remained turned off. This prevents the HFS 9000 from damaging any equipment or devices under test that happen to be connected during power on.
- The phase lock mode is turned off because phase lock requires an external signal to be attached at the time phase lock is turned on. If you need to restore phase lock mode, power the HFS 9000 on, connect the phase lock signal to the **PHASE LOCK IN** connector then turn on phase lock using the Time Base menu **PhaseLockIn** item.

## Configuration

The HFS 9000 can display the configuration of the instrument. Use the **View Config** item in the Cal/Deskew menu. Figure 2–33 shows this menu, and Figure 2–34 shows a typical configuration display.

Cal/Deskew Menu			
press SELECT to view the configuration.			
View Config	Self Test	Calibrate	—
Pretrigger 70ns	Channel A1	Chan Delay 0s	—

Figure 2–33: The Cal/Deskew Menu

```
Instrument Configuration
Firmware          2.0   vec 0, pc=00000000
CPU "035002"      1.1   CPU, Slot 0
TB "037002"      1.2   Time Base
A "036001"       1.3   High Speed Pulse
```

Figure 2–34: A Typical Configuration Display

The configuration display shows the firmware version installed in the HFS 9000, and the cards that are installed. Each card also shows the card ID in quotes. You can change the card ID of any card through a programming interface by using the CAL:CID command.



# Pulse Generators

Pulse generators are the circuitry that generates the pulse signals specified by the time base. The HFS 9PG1 and HFS 9PG2 pulse generator cards each have two pulse generator channels. The HFS 9DG1 and HFS 9DG2 data time generator cards, in addition to their capabilities as data generators, have similar pulse generator capabilities as the HFS 9PG1 and HFS 9PG2 cards, respectively. The HFS 9DG1 and HFS 9DG2 have four pulse generator channels. Thus, your HFS 9000 can have up to 36 pulse generator channels depending on the mainframe and number of cards installed.

The controls for the pulse parameters are in the Pulse Menu (see Figure 2–35). The display above the Pulse Menu shows a representative timing diagram for each channel installed in the HFS 9000. As you change the pulse parameters, you will see their effect on the timing diagram.

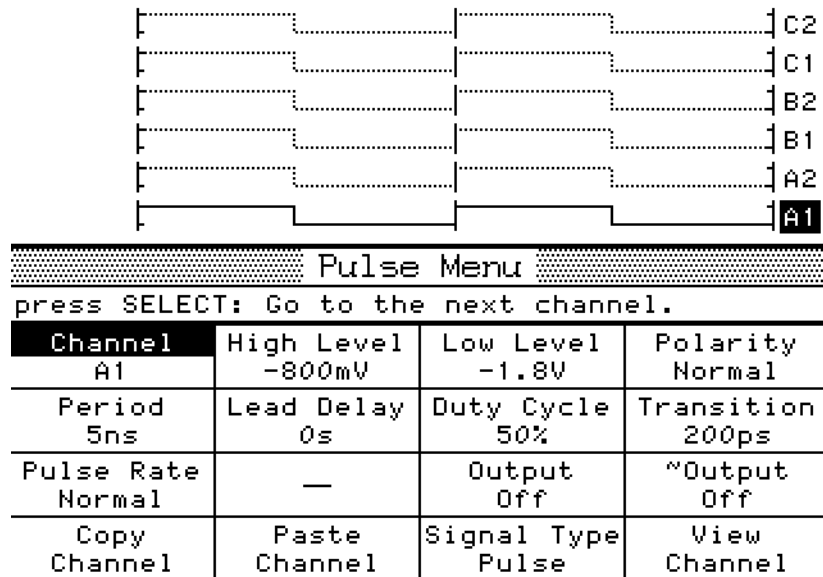

Figure 2–35: The Pulse Menu

The HFS 9000 time base defines windows in time, during which each pulse generator can generate a single pulse. The timing diagram above the Pulse menu shows two full pulse cycles as specified by the time base. The pulse generators can be individually set to generate a pulse with varying leading and trailing edge delays and varying levels.

The **Channel** menu item lets you set which channel the other menu items control. Use the **SELECT** button or the knob to select the channel. Once you have set the desired channel, you can use the other menu items to control parameters for that channel. An alternate method of channel selection is to use the **NEXT CHANNEL** and **PREVIOUS CHANNEL** buttons next to the display.

The selected channel is highlighted in the timing diagram above the Pulse menu. The selected channel has the channel name highlighted, and the timing lines are drawn as solid lines on the display. All non-selected channels are drawn in the timing diagram with dotted lines.

## Turning Channels On and Off

The channel boards provide two output connectors for each channel. These provide both normal and logically inverted output and are labeled **OUTPUT** and **OUTPUT**.

Each output connector has a button to turn on or off its output, and a light indicating whether or not its output is on. You can also turn on or off the normal or inverted output of any channel using the Pulse menu items **Output** and **~Output**.

## Signal Type

Though the HFS 9PG1 and HFS 9PG2 can only generate pulses, an HFS 9DG1 or HFS 9DG2 can generate five different types of signals: Pulse, NRZ (Non-Return to Zero), RZ (Return to Zero), R1 (Return to One), and DC. The signal type is assigned with the **Signal Type** menu item.

To set an HFS 9DG1 or HFS 9DG2 to generate pulses, select the channel using the Channel menu item, select the **Signal Type** menu item, then turn the knob to select the Pulse signal type.

## Voltage Levels

The **High Level** and **Low Level** menu items give you control over the voltages to be used for logical high and logical low. The **Polarity** item lets you invert the logical polarity of any channel.

You can use the **SELECT** button to change **High Level** and **Low Level** into **Amplitude** and **Offset**. Amplitude is the voltage difference between the levels; offset is the voltage level assigned to the midpoint between the levels.

The voltage range for HFS 9PG1 pulse generator cards is  $-2\text{ V}$  to  $+2.6\text{ V}$ , and  $-2\text{ V}$  to  $+5.5\text{ V}$  for HFS 9PG2 cards.

If limiting is on, then the range of voltage levels cannot be set outside the voltage limits. Limiting is controlled with the Levels menu. A complete discussion of limiting appears on page 2–36. The High Level and Low Level menu items in the Levels menu are identical to their counterparts in the Pulse menu.

Adjusting voltage levels does not change the appearance of the Pulse menu timing diagram. The Levels menu provides a graphic display of the pulse generator voltage settings and limits.

## Period/Frequency

Pulse windows can be specified in terms of **Frequency** or in terms of **Period**. Both frequency and period use the same menu item. Choose the way you want to specify pulse windows by pressing the **SELECT** button to alternate between frequency and period. Then use the knob or keypad to set the value.

This menu item is a duplicate of the **Period** (or **Frequency**) item in the Time Base menu.

---

***NOTE.** Period and Frequency are time base parameters and affect all pulse generator channels simultaneously. All other Pulse menu items affect only the selected channel.*

---

## Pulse Timing

You can adjust the timing of the pulse within the pulse window specified by the time base. Two Pulse menu items let you control the pulses in different ways:

- The **Lead Delay** (alternately **Phase**) menu item lets you control when the pulse begins within the window specified by the time base. Choose the way you want to specify the beginning pulse edge by pressing the **Select** button to alternate between Lead Delay and Phase. Then use the knob or keypad to set the value.

**Lead Delay** specifies the time between the beginning of the pulse window and the beginning of the pulse in terms of time. Lead Delay can be set from 0 seconds up.

**Phase** specifies the time between the beginning of the pulse window and the beginning of the pulse in terms of a percentage of the pulse window. Phase can be set from 0% to 100%.

- The **Width** (alternately **Duty Cycle** or **Trail Delay**) menu item lets you control when the trailing edge of the pulse occurs. Choose the way you want to specify the trailing pulse edge by pressing the **SELECT** button to alternate between Width, Duty Cycle, and Trail Delay. Then use the knob or keypad to set the value.

**Width** specifies the pulse width in terms of the time duration of the pulse. Width can be set from 0 seconds up.

**Duty Cycle** specifies the pulse width in terms of a percentage of the pulse window specified by the time base. Duty cycle can be set from 0% to 100%.

**Trail Delay** specifies the trailing edge of the pulse in terms of time from the beginning of the pulse window specified by the time base. Trail delay can be set from 0 seconds up.

## Blinking Menu Items

You can set the menu items described in the Pulse Timing section to conflict. For example, you could set the pulse width to be twice the period of the time base. The HFS 9000 lets you set up conflicts but causes the conflicting menu items to blink. If you see a blinking menu item, look at other menu item(s) that are also blinking. You can resolve the conflict by adjusting any of the blinking menu items.

Sometimes the conflict is between the time base and some other channel. For example, if you change the period, the new value may not conflict with the channel you are viewing. In this case, use the **Channel** menu item to search the other channels to find the conflict.

A common blinking conflict is caused by too little recovery time. This occurs when there is too little time between the end of one pulse and the beginning of the next. The minimum recovery time is 800 ps. The pulse width adjustment range is from zero to one period less 800 ps.

## Rising and Falling Slopes

The **Transition** menu item (HFS9PG2 and HFS 9DG2 cards only) lets you control the rise time and fall time of logic transitions. Enter the desired rise/fall time using the numeric keypad or adjust it with the knob. The HFS 9PG1 and HFS 9PG2 cards do not have variable slope rates. Any attempt to change the displayed value in the **Transition** menu item will result in an error message.

## Half, Quarter, and Eighth Rate Modes

You can set any pulse generator channel to one half, one quarter, or one eighth of the frequency of the time base with the **Pulse Rate** menu item. You can also turn off pulses from the channel by setting the pulse rate to off.

When in half-rate mode, the number of pulses in the pulse burst are half of the number specified in the Time Base menu **Count** item. If the specified count is an odd number, half-rate mode rounds the count up. For example, if the specified count is 5, then in half-rate mode there will be 3 pulses in a burst. The quarter and eighth rates behave in the same fashion as the half-rate mode.

---

***NOTE.** The Trigger Out signal is based on the slowest channel. So, when you use the half, quarter and eighth pulse rate modes, be aware of the effect this will have on the Trigger Out signal.*

---

The ability to change the pulse rate is useful in testing devices. For example, you can use one pulse generator channel running at normal pulse rate as a clock for the device and set another channel to half pulse rate to simulate data to the device under test.

Pulse rate set to off is useful to hold an output at logical high or low during a test. You can use the **Polarity** item to control the output logic level.

## Transducer Mode

The **Transducer** menu item lets you bypass the Stimulus System time base for an HFS 9PG1 or 9PG2 channel. Transducer mode is not available on the HFS 9DG1 or 9DG2 cards. When transducer mode is on, the signal you apply to the **TRANSDUCER IN** connector directly controls the channel pin driver. This allows you to use the fast transition times of the HFS 9000 amplifiers to shape your timing signal.

In transducer mode, only the output levels (including level limits), the transition time control (HFS 9PG2 card only), and the output on/off controls can be used. Timing and polarity controls for the channel are bypassed.

The **TRANSDUCER IN** signal must have a voltage between 1.0 V and 1.5 V peak to peak. The input circuitry removes the DC component by passing the signal through a blocking capacitor, after which the signal is terminated by 50  $\Omega$  to ground.

## Copying Pulse Channel Setups

Once you have set up a channel, you can use the **Copy Channel** and **Paste Channel** menu items to transfer the channel setup to another channel. This simplifies setting up several channels with identical settings and reduces the chance for errors when setting up several channels with identical settings.

To copy a channel setup, first select the channel you wish to copy from using the **Channel** menu item. Select the **Copy Channel** menu item. Then, use the **Channel** menu item or the **NEXT CHANNEL** and **PREVIOUS CHANNEL** buttons to select the channel you wish to copy the setup to. Select the **Paste Channel** menu item. All of the channel parameters except Channel Delay will be copied to the selected channel.

# Reset

You can reset all of the HFS 9000 settings to a known, predefined state. This is useful when you begin using the HFS 9000 after someone else has left it in an unknown state.

The two types of reset are **Reset** and **Factory**.

- **Reset** changes settings in menus to default condition. Reset does not affect stored settings, defined aliases, or GPIB and RS-232-C interface parameters.
- **Factory** resets all the same items as Reset. In addition, Factory removes all stored settings and all alias definitions. Factory does not affect GPIB and RS-232-C interface parameters.

There is no form of reset for communication parameters, either GPIB or RS-232-C.

Reset and Factory are items in the Save/Recall menu (see Figure 2–36). Each presents a verification dialog before executing.

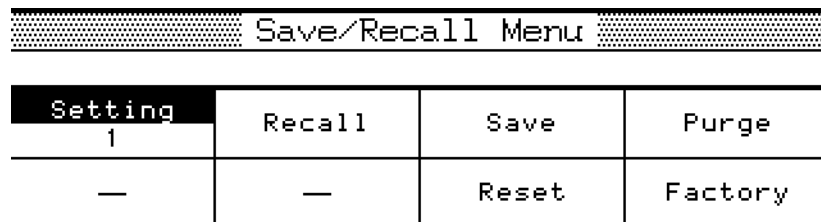

Setting	Recall	Save	Purge
1			
—	—	Reset	Factory

Figure 2–36: The Save/Recall Menu with Reset and Factory Items

## Total Instrument Reset

If you encounter problems or observe certain error messages such as “Calibration memory is corrupted,” you may want to completely reset the HFS 9000. You can perform a total instrument reset which clears and re-establishes all memory in the instrument.

---

**NOTE.** Total instrument reset erases all memory in the HFS 9000, including calibration memory, GPIB and RS-232-C settings, and, optionally, stored settings. Total instrument reset is not normally required and should be considered a corrective action only.

---

To perform a total instrument reset, power off the HFS 9000. Then hold down the **BACKSPACE** button while powering on the HFS 9000. Hold the button down until you see a dialog asking you the type of reset you want. Choose the type of reset you want using the knob or arrow buttons, and press the **Select** button to perform the reset.

- Purging **stored settings** operates identically to a **Factory** reset and does not perform a total instrument reset.
- Purging **calibration and stored settings** performs the total instrument reset.
- **Cancel** performs no reset.

---

**NOTE.** *After a total instrument reset, the HFS 9000 is uncalibrated. The calibration values stored in calibration memory are default values only. You must **Calibrate** the instrument before using it.*

---





## RS-232-C

You can use the serial port (see Figure 2–37) to control the HFS 9000 from a remote terminal or computer that uses an EIA Standard RS-232-C interface. The Reference section of this manual gives you step-by-step details of how to set up the HFS 9000 for remote operation. The following information describes the settings and controls that affect RS-232-C operation.

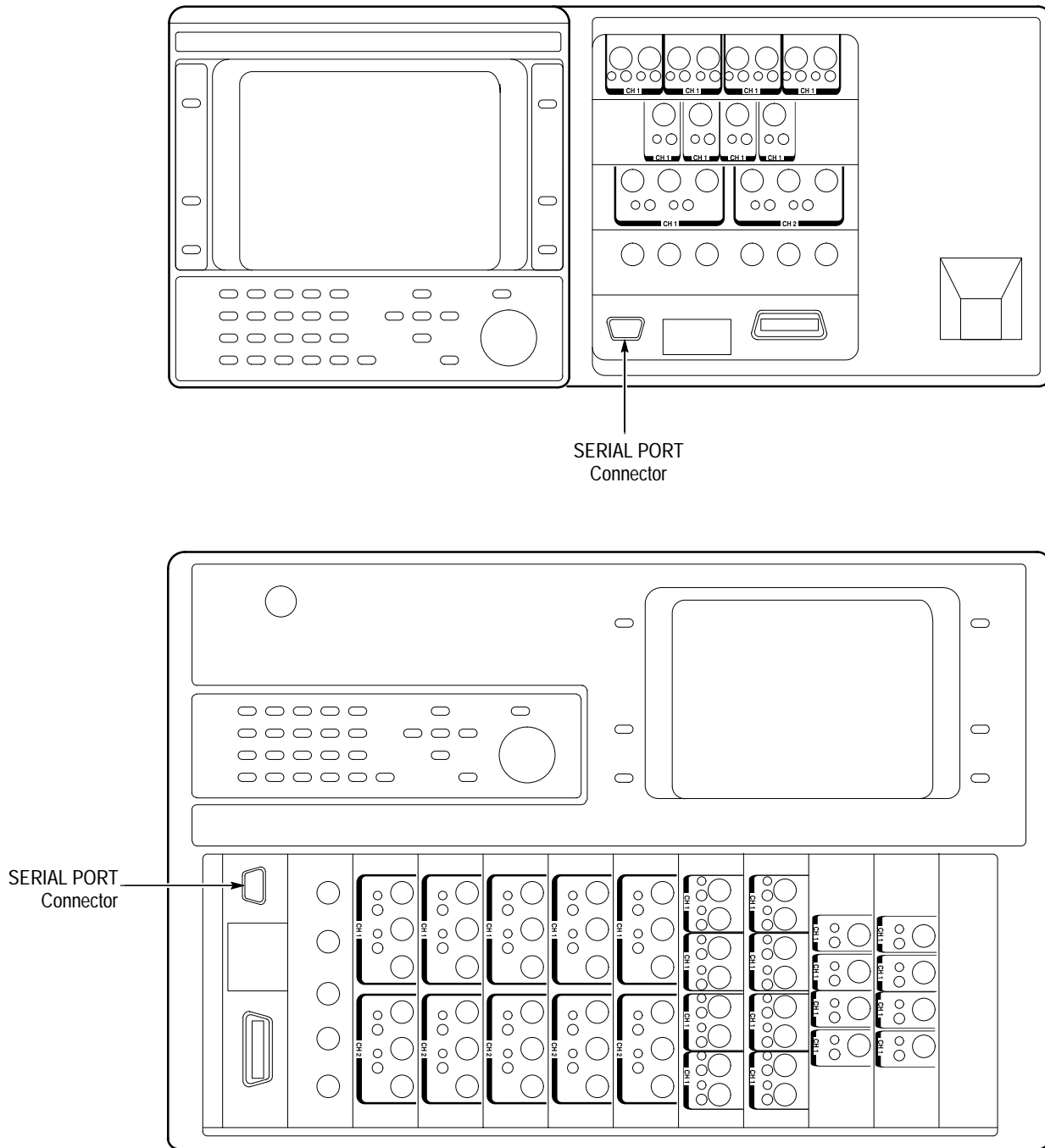

Figure 2-37: SERIAL PORT Connector Location

## The RS-232 Menu

RS-232 Menu			
Baud Rate	Parity	Stop Bits	Flagging
9600	None	1	Soft
Echo	EOL	Delay	Debug
Off	CR-LF	0s	Off

Figure 2–38: The RS-232 Menu

---

**NOTE.** The settings of the RS-232-C parameters are not changed when you reset or factory reset the HFS 9000, or when you recall settings.

---

- **Baud Rate** sets the speed of the RS-232-C interface (see Figure 2–38). Use the knob or keypad to enter the desired baud rate. Set this to the same setting as the terminal or computer you are using.
- **Parity** sets an error-checking communication parameter. Use the **SELECT** button to set the desired parity. You can set parity to even, odd, zero, one, or none. Set parity to the same setting as the terminal or computer you are using.
- **Stop Bits** sets the number of synchronizing bits used for each transmitted data byte. Use the **SELECT** button to set the desired value. You can specify 1, 1.5, or 2 stop bits. Set the stop bits to the same setting as the terminal or computer you are using.
- **Flagging** is a semaphoring parameter. Use the **SELECT** button to specify the desired setting. You can set flagging to hard, soft (sometimes known as XOn/XOff), or none. Set flagging to the same setting as the terminal or computer you are using.

Flagging is a method of preventing data overflow of buffers. Shortly before it can handle no more data, the receiving device flags the sending device to stop sending data until the flag is removed. With hard flagging, one of the cable wires is used to signal flagging. With soft flagging, a specific pair of characters (DC3 and DC1) are used to stop and restart transmission.

---

**NOTE.** Do not use soft flagging when transferring binary data since the data may contain DC3 and DC1 characters. Use hard flagging when transferring binary data.

---

- **Echo** determines whether or not the HFS 9000 sends back a copy of each character immediately upon receipt. Use the **SELECT** button to specify an off or on setting. For most systems, echo will be off.

You can use a terminal to send commands to the HFS 9000 and interactively observe the results. In this mode you will want echo on. For more detail, see Interactive Command Entry on page 3–6.

- **EOL** specifies the type of message terminator that the HFS 9000 puts at the end of every query response. Use the **SELECT** button to specify the desired setting: CR-LF, LF-CR, CR, or LF. A common selection is a carriage return followed by line feed (CR-LF).
- **Delay** sets the amount of time that the HFS 9000 waits after receiving a query before sending the response. Use the knob or keypad to set the desired value. Some systems require some setup time to begin receiving a message, and the delay setting lets you ensure that the HFS 9000 does not respond before the terminal or computer is ready. Delay can be set from 0 to 60 seconds, in 50 ms increments.
- **Debug** specifies whether commands and control settings appear in the HFS 9000 display. When debug is on, a display window appears showing the most recent commands sent to the HFS 9000 and the status of several control settings. Appendix C, Interface Specifications, gives complete information about using debug mode.

# Saved Settings

You can save the state of the HFS 9000 as a saved setting. Later, you can recall the HFS 9000 to exactly those settings. You can save up to 30 different settings. This feature lets you rapidly establish the conditions of a specific test setup, and to rapidly sequence through saved settings for a suite of tests.

Use the Save/Recall menu to store and recall settings. The associated display shows the 30 storage locations for settings and indicates which ones currently have settings stored in them. In Figure 2-39, storage locations 2, 8, and 10 have settings stored in them.

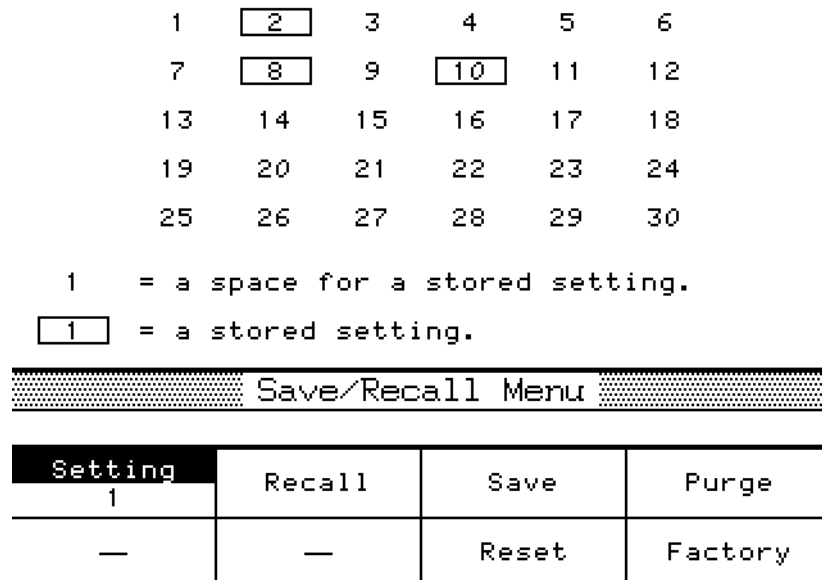

Figure 2-39: The Save/Recall Menu

The top row of menu items relate to saving and recalling settings.

- **Setting** lets you select which storage location you want the **Recall**, **Save**, and **Purge** items to use.
- **Recall** changes all settings of the HFS 9000 to those in the specified storage location. If no setting is stored in that location, you will see an error message. Before the settings are recalled, the HFS 9000 displays a verification dialog to prevent current settings from being replaced accidentally.

---

**NOTE.** Recall does not restore phase lock mode. After a recall, phase lock mode is always off because phase lock requires an external signal to be attached at the time phase lock is turned on. If your setting uses phase lock mode, recall the setting, connect the phase lock signal to the **PHASE LOCK IN** connector, then turn on phase lock using the Time Base menu **PhaseLockIn** item.

---

- **Save** stores a copy of all current settings into the specified storage location. If settings are already stored in that location, the HFS 9000 displays a dialog asking if you want them replaced by the current settings.
- **Purge** removes the stored settings from a storage location leaving it empty. The HFS 9000 always displays a verification dialog to prevent inadvertent loss of stored settings.

## Purging All Saved Settings

If you want to remove all the saved settings, you can select them one by one and purge them with the **Purge** menu item. A faster method is to perform a **Factory** reset. However, this has the side effect of changing all current settings.

Both factory reset and regular reset are items in the Save/Recall menu. The Reset section on page 2–51 has more information about both types of reset.

# Self Test

The HFS 9000 is equipped with an extensive suite of self-test diagnostic routines. These routines are run each time you power on the HFS 9000. They can also be run any time you wish by selecting the Cal/Deskew menu **Self Test** item (see Figure 2-40).

Cal/Deskew Menu			
press SELECT to run instrument self-tests.			
View Config	Self Test	Calibrate	—
Pretrigger 70ns	Channel A1	Chan Delay 0s	—

Figure 2-40: The Cal/Deskew Menu

Self test indicates the circuits being tested as the tests are performed. If the tests pass successfully, the HFS 9000 continues what it was doing at the time the self tests were run: the power up completes or the Cal/Deskew menu is displayed ready for the next selection.

If the self test fails at any test, the HFS 9000 halts with an error indication on the display that identifies which test has failed. The display also presents you with two choices:

- Press any button other than the **SELECT** button to show a terse description of the failure. This additional information may be of assistance to repair personnel.
- Press the **SELECT** button to continue with the next diagnostic test.

If you display the terse description, you must then press the **SELECT** button to continue with the next diagnostic test.

Self-test failure does not prevent you from continuing to use the HFS 9000. However, you should not assume the HFS 9000 meets specifications or is fully operational unless it passes the self test successfully.





# Time Base

The time base controls the timing of all channels of the HFS 9000. The time base defines times when the pulse channels will generate pulses. The time base can be externally triggered and phase locked to an external signal. The time base can provide an external trigger for other instruments.

## Timing and Trigger Relationships

The time base specifies when the pulse generator will create pulses relative to a trigger event detected at the **TRIGGER IN** connector. The timing setting items are in the Time Base menu and include the **Pretrigger** item in the Cal/Deskew menu (see Figure 2-41).

Time Base Menu			
press SELECT: Auto Burst ▶ Auto-Burst Trig-Auto			
Mode	Period	Count	Out Period
Auto-Burst	1.7ns	1	1
Trigger In	Trig Slope	Trig Level	PhaseLockIn
On	Positive	0V	Off
Run/Stop	—	—	—
Running			

Cal/Deskew Menu			
press SELECT to view the configuration.			
View Config	Self Test	Calibrate	—
Pretrigger 70ns	Channel A1	Chan Delay 0s	—

Figure 2-41: The Time Base and Cal/Deskew Menus

The time base does not directly determine the placement of pulses. The time base defines windows in time during which each channel can generate a pulse. The pulse generators can be individually set to generate a pulse during each of these windows in time with varying leading and trailing edge delays and levels. The Pulse Generator section on page 2-45 describes parameters that can be set individually for each pulse generator.

To set the time base mode, highlight the **Mode** menu item and press the **SELECT** button repeatedly until the desired mode is set. The four modes are Burst, Auto-Burst, Auto, and Trig-Auto.

**Burst Mode**

In burst mode, the HFS 9000 waits for a trigger event at the **TRIGGER IN** connector, a remote \*TRG command, or a press of the **MANUAL TRIGGER** button. When a trigger event is detected, the HFS 9000 waits for approximately 130 ns (the startup delay) before generating pulses. The time base then generates the number of pulse event windows specified by **Count** and awaits the next trigger event. The beginning of the first pulse window is the time zero reference.

***NOTE.** See the Deskew section on page 2–25 for information on compensating for the 130 ns startup delay.*

Pulse windows can be specified in terms of **Frequency** or **Period**. Both frequency and period use the same menu item. Choose the way you want to specify pulse windows by pressing the **SELECT** button to alternate between frequency and period. Then use the knob or keypad to set the value.

Displayed above the Time Base and Cal/Deskew menus is a timing diagram. When the Frequency/Period, Count, or Pretrigger menu items are highlighted, arrows and dotted lines annotate the timing diagram to illustrate the parameter controlled by that menu item. Figure 2–42 shows this timing diagram when the Count menu item is highlighted.

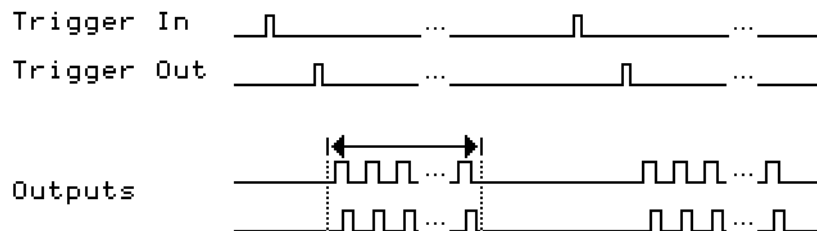

Time Base Menu

Mode Burst	Period 5ns	<b>Count</b> 64	Out Period 1
Trigger In On	Trig Slope Positive	Trig Level -1.3V	PhaseLockIn Off
Run/Stop Running	—	—	—

**Figure 2–42: The Timing Diagram, Illustrating the Count Parameter**

<b>Auto-Burst Mode</b>	Auto-burst mode operates much the same as burst mode, except that the HFS 9000 creates its own trigger events. There is a fixed delay of approximately 15 $\mu$ s between pulse bursts.
<b>Auto Mode</b>	Auto mode operates as a continuous source of pulse windows without waiting for any trigger events or startup delays in the series of pulses.
<b>Trig-Auto Mode</b>	In Trig-Auto, the output is the same as with Auto mode but output does not begin until a trigger event is received. The HFS 9000 waits for a trigger event at the <b>TRIGGER IN</b> connector, a remote *TRG command, or a press of the <b>MANUAL TRIGGER</b> button.

## Stopping the Time Base

You can stop the time base with the **Run/Stop** menu item. To stop the time base, select the **Run/Stop** menu item and turn the knob to select off. This menu item performs the same function as the front-panel **RUN/STOP** button.

When the time base stops, the logic state of the outputs depends on the mode the time base is in. Table 2–2 shows the logic state of the output according to what time base mode the instrument is in.

**Table 2–2: Logic State of Outputs When Time Base Stopped**

Time Base Mode	Output State
Burst and Auto-Burst	The HFS 9000 completes the defined burst and holds and the outputs at the logic level of the last bit.
Auto and Trig-Auto	No specified output state

**Single-Step Operation** For Single-Step operation, use the following procedure:

1. Set the time base to Auto Mode.
2. Program Start, Loop, and End to the same address.
3. Press Run to begin operation and Stop to end operation.
4. Perform steps 2 and 3 for the next address.

## Blinking Menu Items

You can set the menu items described in the Pulse Timing section to conflict. For example, you could set the pulse width to be twice the period of the time base. The HFS 9000 lets you set up conflicts but causes the conflicting menu items to blink. If you see a blinking menu item, look at other menu item(s) that are also blinking. You can resolve the conflict by adjusting any of the blinking menu items.

Sometimes the conflict is between the time base and some other channel. For example, if you change the period the new value may not conflict with the channel you are viewing. In this case, use the **Channel** menu item to search the other channels to find the conflict.

## Trigger In

The Time Base menu gives you control of the detection of trigger events at the **TRIGGER IN** connector. There are four Trigger In menu items:

- **Trigger In** can be set to on or off. When Trigger In is set to off, no trigger events can be detected at the **TRIGGER IN** connector. (When in phase lock mode, setting **Trigger In** to on enables the **FRAME SYNC IN** connector.) This is useful when you want to use the **MANUAL TRIGGER** button to trigger pulse bursts.
- **Trig Slope** can be set to positive or negative. When **Trig Slope** is set to positive, a trigger event occurs on a positive-going edge on the trigger in signal as it passes through the voltage level specified by **Trig Level**. When **Trig Slope** is set to negative, a trigger event occurs on a negative-going edge.
- **Trig Level** lets you set the voltage level at which a trigger events occur.
- **PhaseLockIn** lets you synchronize and lock in the HFS 9000 to an external timing source connected to the **PHASE LOCK IN** and **FRAME SYNC IN** connectors. For complete information about using phase lock, see the Phase Lock section on page 2–39.

## Manual Trigger

When the HFS 9000 is in Burst or Trig-Auto mode (set using the Time Base menu **Mode** item), you can use the **MANUAL TRIGGER** button to trigger the generation of pulse bursts.

If you have a trigger signal connected to the **TRIGGER IN** connector, you do not have to disconnect it to use manual triggering. Instead, turn off the trigger in signal by setting the Time Base menu **Trigger In** item to off.

## Trigger Out

You can set the HFS 9000 to produce an external trigger signal at the **TRIGGER OUT** connector. Use this output signal to trigger an external detection device such as an oscilloscope.

The Time Base menu **Out Period** menu item lets you specify which pulse window in the burst will generate the output trigger. For example, an out period setting of 16 will generate an output trigger at the beginning of the sixteenth pulse window. Also, the trigger out signal tracks the slowest channel. If you engage the Half, Quarter or Eighth Rate modes (set with the **Pulse Rate** menu item), be aware of the effect this will have on the trigger out signal.

Trigger Out timing is modified by the Cal/Deskew menu **Pretrigger** item. The default pretrigger setting of 70 ns means that the trigger out signal appears 70 ns before the beginning of the pulse window.

---

***NOTE.** The beginning of the pulse window does not necessarily coincide with the leading edge of any generated pulse. The Pulse menu lets you specify the timing of each pulse leading edge relative to the beginning of the pulse window.*

---

Whenever the time base is set to Auto mode, the HFS 9000 generates a trigger out signal for each pulse window.



# Trigger

The time base of the HFS 9000 can be externally triggered and can be phase locked to an external signal. The HFS 9000 can also provide an external trigger signal for other instruments.

## Timing and Trigger Relationships

The time base specifies when the pulse generator will create pulses relative to a trigger event detected at the **TRIGGER IN** connector. The timing setting items are in the Time Base menu and include the **Pretrigger** item in the Cal/Deskew menu (see Figure 2-43).

Time Base Menu			
press SELECT: Auto Burst ▶ Auto-Burst Trig-Auto			
Mode	Period	Count	Out Period
Auto-Burst	1.7ns	1	1
Trigger In On	Trig Slope Positive	Trig Level 0V	PhaseLockIn Off
Run/Stop Running	—	—	—

Cal/Deskew Menu			
press SELECT to view the configuration.			
View Config	Self Test	Calibrate	—
Pretrigger 70ns	Channel A1	Chan Delay 0s	—

Figure 2-43: The Time Base and Cal/Deskew Menus

## Trigger In

The Time Base menu gives you control of the detection of trigger events at the **TRIGGER IN** connector. There are four Trigger In menu items:

- **Trigger In** can be set to on or off. When Trigger In is set to off, no trigger events can be detected at the **TRIGGER IN** connector. (When in phase lock mode, setting **Trigger In** to on enables the **FRAME SYNC IN** connector.) This is useful when you want to use the **MANUAL TRIGGER** button to trigger pulse bursts.

- **Trig Slope** can be set to positive or negative. When **Trig Slope** is set to positive, a trigger event occurs on a positive-going edge on the trigger in signal as it passes through the voltage level specified by **Trig Level**. When **Trig Slope** is set to negative, a trigger event occurs on a negative-going edge.
- **Trig Level** lets you set the voltage level at which trigger events occur.
- **PhaseLockIn** lets you synchronize and lock in the HFS 9000 to an external timing source connected to the **PHASE LOCK IN** and **FRAME SYNC IN** connectors. For complete information about using phase lock, see the Phase Lock section on page 2–39.

## Manual Trigger

When the HFS 9000 is in Burst or Trig-Auto mode (set using the Time Base menu **Mode** item), you can use the **MANUAL TRIGGER** button to trigger the generation of pulse bursts.

If you have a trigger signal connected to the **TRIGGER IN** connector, you do not have to disconnect it to use manual triggering. Instead, turn off the trigger in signal by setting the Time Base menu **Trigger In** item to off.

## Trigger Out

You can set the HFS 9000 to produce an external trigger signal at the **TRIGGER OUT** connector. Use this output signal to trigger an external detection device such as an oscilloscope.

The Time Base menu **Out Period** menu item lets you specify which pulse window in the burst will generate the output trigger. For example, an out period setting of 16 will generate an output trigger at the beginning of the sixteenth pulse window. Also, the trigger out signal tracks the slowest channel. If you engage the Half, Quarter or Eighth Rate modes (set with the **Pulse Rate** menu item), be aware of the effect this will have on the trigger out signal.

Trigger Out timing is modified by the Cal/Deskew menu **Pretrigger** item. The default pretrigger setting of 70 ns means that the trigger out signal appears 70 ns before the beginning of the pulse window.

In auto mode the frequency of the trigger out tracks the slowest channel.

---

***NOTE.** The beginning of the pulse window does not necessarily coincide with the leading edge of any generated pulse. The Pulse menu lets you specify the timing of each pulse leading edge relative to the beginning of the pulse window.*

---





# Setting Up the Instrument

This section tells you how to prepare the HFS 9000 Stimulus System for use with a remote controller, terminal, or computer. The first part of this section explains how to connect the HFS 9000 to a controller, terminal, or computer through the **GPIB** or **SERIAL PORT** (RS-232-C) interface. The rest of the section describes how to use the HFS 9000 front panel settings to enable the HFS 9000 to send and receive messages to and from a remote controller.

## Controllers

You can control the HFS 9000 with a remote controller or computer that uses the IEEE Standard 488.2-1987 (GPIB) interface. Alternately, you can control the HFS 9000 with a remote terminal or computer that uses the EIA Standard RS-232-C interface.

If you will be using the serial port RS-232-C interface, refer to RS-232-C on page 2–53. If you will be controlling your HFS 9000 through the GPIB interface, read the following section.

## Using the GPIB Interface

Connect your HFS 9000 to the GPIB using an IEEE STD 488 GPIB cable (available as Tektronix part number 012-0991-00). The HFS 9000 has a 24-pin **GPIB** connector on its front panel (see Figure 3–1). This connector has a D-type shell and conforms to IEEE STD 488.

You can stack GPIB connectors as shown in Figure 3–2.

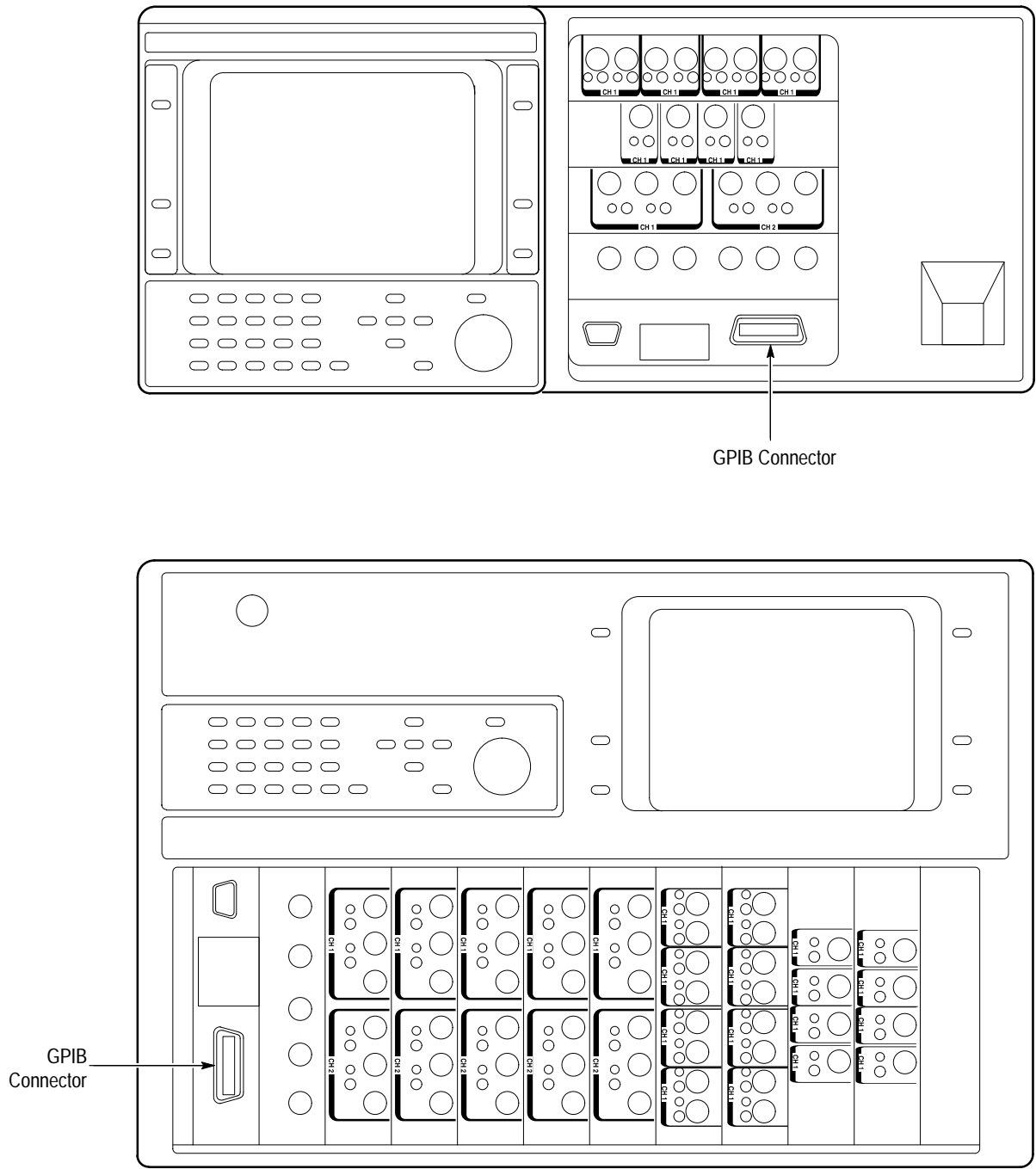
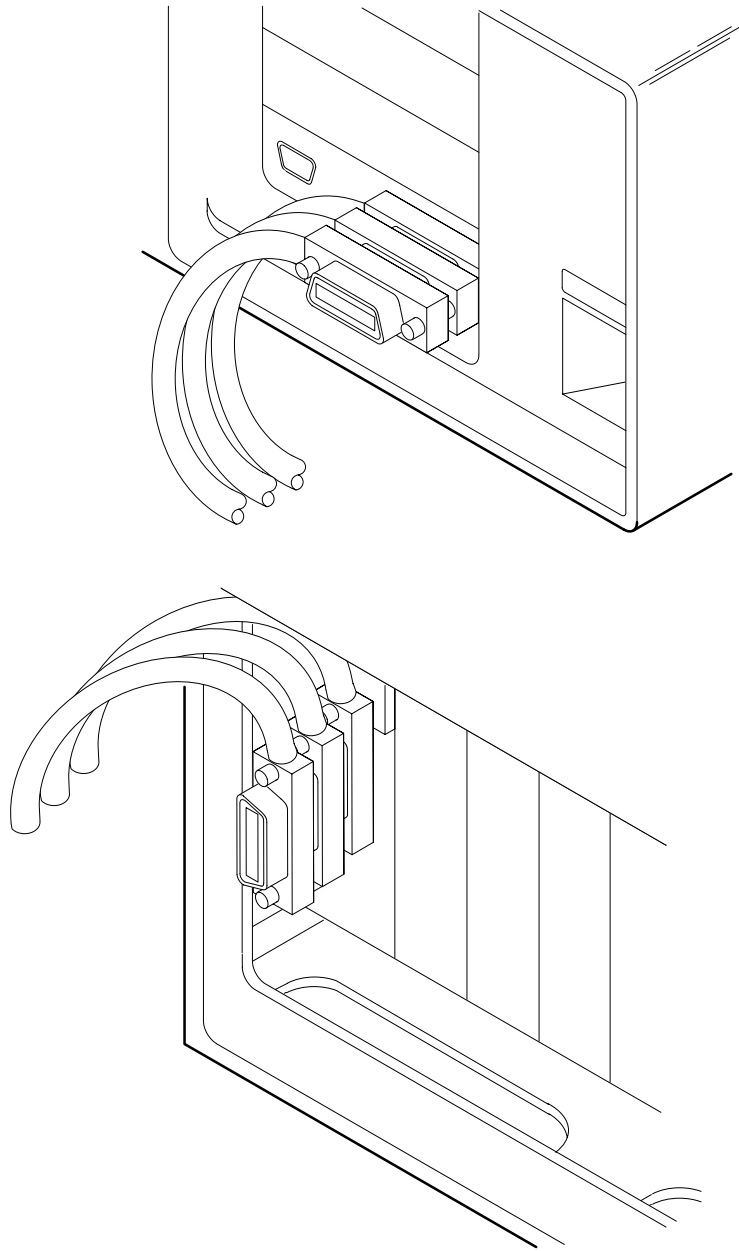

Figure 3-1: GPIB Connector Location



**Figure 3-2: How to Stack GPIB Connectors**

### **GPIB Requirements**

Observe these rules when you use your HFS 9000 with a GPIB network:

- Each device on the bus must be assigned a unique device address; no two devices can share the same device address.
- Do not connect more than 15 devices to any one bus.
- Connect one device for every 6 feet (2 meters) of cable used.

- Do not use more than 65 feet (20 meters) of cable to connect devices to a bus.
- At least two-thirds of the devices on the network must be turned on while the network is operating.
- Connect the devices on the network in a star or linear configuration as shown in Figure 3–3. Do not use loop or parallel configurations.

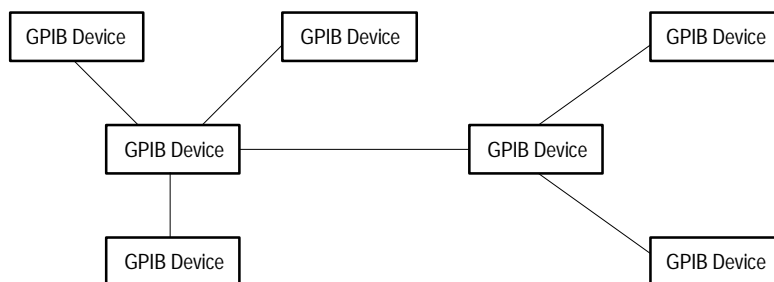

Figure 3–3: Typical GPIB Network Configurations

*Appendix C: Interface Specifications*, gives additional information on the HFS 9000 GPIB configuration.

### Setting the GPIB Parameters

Once you have connected your HFS 9000 through the GPIB interface, you need to set its GPIB parameters to allow it to communicate through the interface.

1. Display the GPIB Menu: press the **Main Menu** button, use the arrow buttons to highlight the **GPIB Menu** item, and press the **SELECT** button. Figure 3–4 shows this menu.

GPIB Menu			
Address	On Bus	—	Debug
1	On	—	Off

Figure 3–4: The GPIB Menu

2. Use the arrow buttons to highlight the **Address** item and the knob or keypad to enter the desired GPIB device address. You may use any number from 0 through 30.
3. If the **On Bus** item is set to off, use the arrow buttons to highlight the **On Bus** item, then press the **SELECT** button.

4. If the **Debug** item is not set as you wish, use the arrow buttons to highlight the **Debug** item, then press the **SELECT** button.

When debug is on, a display window shows the most recent commands sent to the HFS 9000 and the status of several control settings. Appendix C, Interface Specifications, gives complete information about using debug mode.

Once you have set these parameters, you can control the HFS 9000 through the GPIB interface.

---

***NOTE.** The HFS 9000 must use the same baud rate, parity, and stop bit settings as the controller. Also, the controller's RS-232-C port must be set for 8-bit characters.*

---

5. Use the arrow buttons to highlight the **Baud Rate** item and the knob or keypad to set the desired speed of the RS-232-C interface. Set this to the same baud rate setting as the terminal or computer you are using.
6. Use the arrow buttons to highlight the **Parity** item and the **Select** button to set the desired parity. Parity is an error-detecting communication parameter. You can set parity to even, odd, or none. Set parity to the same setting as the terminal or computer you are using.
7. Use the arrow buttons to highlight the **Stop Bits** item and the **SELECT** button to set the number of synchronizing bits per transmitted data byte. You can specify 1, 1.5, or 2 stop bits. Set the stop bits to the same setting as the terminal or computer you are using.
8. Use the arrow buttons to highlight the **Flagging** item and the **SELECT** button to specify the desired setting. You can set flagging to hard, soft (sometimes known as XOn/XOff), or none. Set flagging to the same setting as the terminal or computer you are using.

Flagging is a method to prevent data overflow of buffers. Shortly before it can handle no more data, the receiving device flags the sending device to stop sending data until the flag is removed. With hard flagging, one of the cable wires is used to signal flagging. With soft flagging, a specific pair of characters (DC3 and DC1) is used to stop and restart transmission.

---

***NOTE.** Do not use soft flagging when transferring binary data since the data may contain DC3 and DC1 characters. Use hard flagging when transferring binary data.*

---

9. Use the arrow buttons to highlight the **Echo** item, and use the **SELECT** button to specify the desired setting: off or on. For most systems, echo will be off. With echo on, whenever the HFS 9000 receives a character from the

terminal or computer, it sends the same character back to the terminal or computer before acting on it.

---

***NOTE.** If you use a terminal to send commands to the HFS 9000 and interactively observe the results, set Echo to on. For more detail, refer to Interactive Command Entry on page 3–6.*

---

10. Use the arrow buttons to highlight the **EOL** item and the **SELECT** button to specify the character sequence the HFS 9000 appends to all messages it sends: CRLF, LFCR, CR, or LF. For most systems, CRLF is the proper setting. EOL specifies the message terminator that the HFS 9000 puts at the end of every query response.
11. Use the arrow buttons to highlight the **Delay** item and the knob or keypad to set the desired value. Delay can be set from 0 to 60 seconds in 50 ms increments. Delay is the amount of time that the HFS 9000 waits after receiving a query before sending the response. Some systems require some setup time to begin receiving a message; the delay setting lets you ensure that the HFS 9000 does not respond before the terminal or computer is ready.
12. If the **Debug** item is not set as you wish, use the arrow buttons to highlight the **Debug** item and press the **SELECT** button.

When debug is on, a display window shows the most recent commands sent to the HFS 9000, and the status of several control settings. Appendix C, Interface Specifications, gives complete information about using debug mode.

Once you have set these parameters, you can use the RS-232-C interface to control your HFS 9000.

---

***NOTE.** You will need to consult the documentation for your computer to determine how commands are sent and messages are received from within the computer's programming language.*

---

## Interactive Command Entry

When you are using a CRT or hardcopy terminal with the HFS 9000 or are using terminal emulation software on your controller, you can send commands to the HFS 9000 and observe the results interactively. In this mode, turn echo on to use these echo features:

- Whenever the HFS 9000 is ready for the next command, it sends a “>” prompt to the terminal or controller. When this prompt appears, enter a command or query and a termination (CR or LF).

- All input is buffered, so the HFS 9000 will not analyze and act on a command until the complete command is sent and a terminator is received.
- Until the command terminator is received, you can use the following characters to edit the command you are entering:

Control-R retypes the input command being typed and places the cursor at the right of the last character entered.

Control-U deletes the input command being typed and prompts again for another input.

Back Space and Delete erase the last character entered.

Backslash (\) lets you place special characters such as CR, LF, Back Space, and Backslash into the command. Type “\” followed by the desired special character. The Backslash is not echoed to your terminal.

- You can use CR to terminate commands sent to the HFS 9000. Normally, only LF is recognized as a message terminator.





# Command Syntax

You can control the HFS 9000 through the GPIB and RS-232-C interfaces using a large group of commands and queries. This section describes the syntax these commands and queries use, and the conventions the HFS 9000 uses to process them. The commands and queries themselves are listed in the Commands section.

Transmit commands to the HFS 9000 using the enhanced American Standard Code for Information Interchange (ASCII) character encoding. Appendix C includes a chart of the ASCII character set.

This manual uses Backus-Naur Form (BNF) notation and syntax diagrams to describe commands and queries. The syntax diagrams follow the notations and conventions of the ANSI/IEEE Standard 488.2-1987, section 7.2.

This manual uses the following BNF symbols:

**Table 3-1: BNF Symbols and Meanings**

Symbols	Meaning
< >	Defined element
::=	Is Defined As
	Exclusive OR
{ }	Group; one element is required
[ ]	Optional
. . .	Previous element(s) may be repeated
( )	Comment

## Clearing the HFS 9000

You can stop any query or process by using the Device Clear (DCL) GPIB command. The HFS 9000 RS-232-C interface emulates the GPIB device clear function by responding to a break signal from your terminal's **Break** key. This will also stop any query or process.

## Command and Query Structure

Commands consist of set commands and query commands (usually called commands and queries). Commands modify instrument settings or tell the

HFS 9000 to take a specific action. Queries cause the HFS 9000 to return information about its status.

Most commands have both a set and query forms. The query form of the command is the same as the set form but with a question mark on the end. For example, the set command `PGENA:CH1:HIGH` has a query form `PGENA:CH1:HIGH?`. Not all commands have both a set and query form; some commands are set only and some are query only.

A command message is a command or query name, followed by any information the HFS 9000 needs to execute the command or query. Command messages consist of three different element types defined in Table 3–2 and shown in the example in Figure 3–5.

**Table 3–2: Command Message Elements**

Symbol	Meaning
<Header>	The basic command name. If the header ends with a question mark, the command is a query. The header may begin with a colon (:) character; if the command is concatenated with other commands the beginning colon is required. The beginning colon can never be used with command headers beginning with star (*).
<Mnemonic>	A header sub-function. Some command headers have only one mnemonic. If a command header has multiple mnemonics, they are always separated from each other by a colon (:) character.
<Argument>	A quantity, quality, restriction, or limit associated with the header. Not all commands have an argument, while other commands have multiple arguments. Arguments are separated from the header by one or more space characters. Arguments are separated from each other by a <Separator>.
<Separator>	A separator between arguments of multiple-argument commands. The separator can consist of a comma, or a comma with blank characters before and after it.

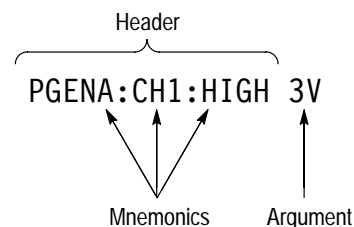

**Figure 3–5: Command Message Elements**

**Commands** Commands cause the HFS 9000 to perform a specific function or change one of its settings. Commands have the structure:

- [ : ] <Header> [ <Space> <Argument> [ <Separator> <Argument> ] . . . ]

**Queries** Queries cause the HFS 9000 to return information about its status or settings. Queries have the structure:

- [ : ] <Header> ?
- [ : ] <Header> ? [ <Space> <Argument> [ <Separator> <Argument> ] . . . ]

If you use only a partial header in a query command, the HFS 9000 returns information about all the possible mnemonics that you have left unspecified. For example, `TBAS:TIN:SLOPE?` returns the slope setting for the time base **Trigger In** connector, while `TBAS:TIN?` returns the settings for the time base Trigger In connector (input, level, and slope), and `TBAS?` returns all the settings for the entire time base.

### Headers in Query Responses

You can control whether or not headers are returned by the HFS 9000 as part of the query response. Use the `HEADER` command to control this feature. If header is on, command headers are returned as part of the query and the query response is formatted as a valid set command. When header is off, only the values are sent back in the response which may be easier to parse and extract information. Table 3–3 shows the difference in responses.

**Table 3–3: Comparison of Header On and Off Responses**

Query	Header Off Response	Header On Response
<code>TBAS:MODE?</code>	AUTO	<code>:TBAS:MODE AUTO</code>
<code>TBAS:COUNT?</code>	100	<code>:TBAS:COUNT 100</code>

## Command Entry

- You can enter commands in upper or lower case.
- You can precede any command with blank characters. Blank characters include any combination of the ASCII control characters 00 through 09 and 0B through 20 hexadecimal (0 through 9 and 11 through 32 decimal).
- The HFS 9000 ignores commands consisting of any combination of blank characters, carriage returns, and line feeds.

### Abbreviating Commands

Many HFS 9000 commands can be abbreviated. These abbreviations are shown in capital letters for each command in the Commands section. For example, the command `TBAS:PERiod` can be entered simply as `TBAS:PER` or `tbas:per`.

If you use the `HEADER` command to include command headers in query responses, you can further control whether the returned headers are abbreviated or are full-length. The `VERBOSE` command lets you control this.

### Concatenating Commands

You can concatenate any combination of set commands and queries using a semicolon (;). The HFS 9000 executes concatenated commands in the order received. Concatenating commands is useful when you want to avoid events generated by conflicting settings — see [Conflicts](#) on page 3–134.

When concatenating commands and queries you must follow these rules:

1. Completely different headers must be separated by a semicolon and the beginning colon on all commands but the first. For example, the commands `TBAS:MODE AUTO` and `PGENA:CH1:WIDTH 2ns` would be concatenated into a single command:

```
TBAS:MODE AUTO;:PGENA:CH1:WIDTH 2ns
```

2. If concatenated commands have headers that differ by only the last mnemonic, you can abbreviate the second command and eliminate its beginning colon. For example, the commands `TBAS:MODE BURST` and `TBAS:COUNT 100` could be concatenated into a single command:

```
TBAS:MODE BURST;COUNT 100
```

the longer version works equally well:

```
TBAS:MODE BURST;:TBAS:COUNT 100
```

3. Never precede a star (\*) command with a colon:

```
TBAS:MODE BURST;COUNT 100;*TRG
```

4. When you concatenate queries, the responses to all of the queries are concatenated into a single response message. For example, if the time base mode is burst and count is set to 100, the concatenated query

```
TBAS:MODE?;COUNT?
```

will return either `:TBAS:MODE BURST;:TBAS:COUNT 100` if header is on, or `BURST;100` if header is off.

5. Set commands and queries may be concatenated in the same message. For example:

```
TBAS:MODE BURST;PERIOD 10ns;COUNT?;:PGENA:CH1:WIDTH?
```

is a valid message that sets the time base mode to burst, the time base period to 10 ns, and responds with the time base count setting and the width setting of channel A1. Concatenated commands and queries are executed in the order received.

Here are some invalid concatenations with an explanation of why they are invalid:

- `TBAS:MODE AUTO;PGENA:CH1:WIDTH 2 ns`  
There is no colon before PGENA.
- `TBAS:MODE BURST;:COUNT 100`  
There is an extra colon before COUNT; `TBAS:COUNT` could be used instead.
- `TBAS:MODE BURST;:*TRG`  
There is an extra colon before a star (\*) command.
- `PGENA:CH1:WIDTH 1ns;CH2:WIDTH 2ns`  
The two commands differ in the middle mnemonic; you can abbreviate only if the commands differ by the last mnemonic.  
Place `:PGENA:` in front of CH2.

## Message Terminators

This manual uses `<EOI>` (End or Identify) to represent a message terminator.

Symbol	Meaning
<code>&lt;EOI&gt;</code>	Message terminator

If you use a GPIB network, `<EOI>` can be the IEEE-488 EOI interface symbol or LF (line feed).

If you use an RS-232-C network, you can use CR (carriage return), LF (line feed), CRLF (carriage return followed by a line feed), or LFCR (line feed followed by a carriage return) as the output terminator (EOL string). When using RS-232-C with echo off, the HFS 9000 accepts only LF (line feed) as an input message terminator.

The end-of-message terminator may be either the END message (EOI asserted concurrently with the last data byte), or the ASCII code for line feed (LF) sent as the last data byte.

## Argument Types

The argument of a command may be in one of several forms. The individual descriptions of each command tell which argument types to use with that command.

### Quoted String Arguments

Some commands accept or return data in the form of a quoted string, a group of ASCII characters enclosed by apostrophes (') or quotation marks ("). For example,

```
"this is a quoted string"
```

```
'this is also a quoted string'
```

Symbol	Meaning
<QString>	Quoted string of ASCII text

Follow these rules when you use quoted strings:

- A quoted string can include any character defined in the 7-bit ASCII character set.
- Use the same type of quote character to open and close the string. For example,
 

```
"this is correct"
```

```
'and this is correct'
```

```
"but this is not"
```
- You can mix quotation marks and apostrophes within a string as long as you follow the previous rule. For example,
 

```
"this is an 'acceptable' string"
```

```
'this is also an "acceptable" string'
```
- You can include a quote character within a string simply by repeating the quote. For example,
 

```
"here is a "" mark"
```

```
'here is a '' mark'
```
- Strings can have upper or lower case characters.
- If you use a GPIB network, you cannot terminate a quoted string with an EOI interface signal before the closing delimiter. For example, the following string is invalid:
 

```
"test<EOI>"
```
- A carriage return or line feed imbedded in a quoted string does not terminate the string, but is treated as just another character in the string.

**Block Arguments** Several HFS 9000 commands use a block argument form:

Symbol	Meaning
<Block>	A block of binary data bytes
<NZDig>	A digit character in the range 0–9 (note that 0 is treated as a special case)
<Dig>	A digit character in the range 0–9
<DChar>	A character with the binary equivalent of 0 through FF hexadecimal (0 through 255 decimal)

The block argument is in one of the two following formats:

- <Block> ::= #<NZDig><Dig>[<Dig>. . .][<DChar>. . .]
- <Block> ::= #0[<DChar>. . .]<EOI>

<NZDig> specifies the number of <Dig> elements that follow. Taken together, the <Dig> elements form a decimal integer that specifies how many <DChar> elements follow (see Figure 3–6).

If the second form is used, it means that the number of <DChar> elements to follow is unknown and that the end of the block of data bytes will be identified by EOI. So, when <NZDig> is zero, everything that follows is treated as data until an EOI character is encountered. This form should not be used with the RS-232-C interface or with GPIB controllers that have LF termination only.

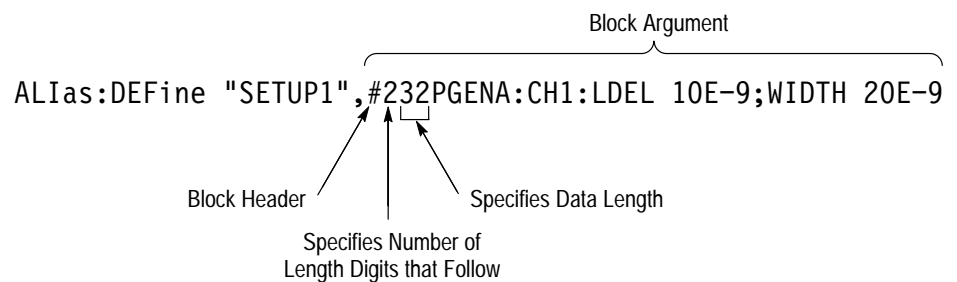

**Figure 3–6: Block Argument Example**



### Numeric Arguments

Many HFS 9000 commands require numeric arguments. This manual represents these arguments as follows:

Symbol	Meaning
<NR1>	Signed integer value
<NR2>	Floating point value without an exponent
<NR3>	Floating point value with an exponent
<NRf>	Flexible numeric argument {NR1   NR2   NR3}. A suffix composed of a multiplier (letter exponent) and units may be used as an alternate to NR3. For example, this numeric type would let you use "10ns" as an alternate to "10E-9"

### Card-Channel Mnemonics

The HFS 9000 has up to nine pulse generator cards depending on the mainframe. Most commands specify the card to address as a part of the first mnemonic in the header. Which channel to address is the second mnemonic in the header.

Symbol	Meaning
<x>	A card specifier, either A, B, C, D, E, F, G, H, or I.
CH<n>	A channel specifier; <n> is either 1, 2, 3, or 4.

The <Header> can be a simple command name or a command name with a card designator:

- <Header> ::= {<Command Name> | <Command Name><Card>}

Similarly, all Sub-Headers that begin with CH specify the channel.

For example, in the command PGENB:CH1:WIDTH 20ms, the header PGENB specifies the B pulse generator card, and the sub-header CH1 specifies channel 1 on that card.

### Channel Arguments

The HFS 9000 has up to nine pulse generator cards depending on the mainframe. Pulse Generator cards have two output channels; Data Time Generator cards have four output channels. When you use the front panel to control the HFS 9000, use a unique channel name to identify each channel. A few programming commands that deal with the front panel specify output channels according to their front-panel channel name.

Symbol	Meaning
<Channel>	A channel specifier, for example A1, A2, B1, B2, B3, B4, F1, or F2

Channel arguments are made up of a letter that specifies the card (A, B, C, D, E, F, G, H, or I) and a channel number (1, 2, 3, or 4). For example, output channel 1 of the second card is identified as channel B1. So, to specify the B card channel 2 in such a command, it would be written as `FPAN:DChannel "B2"`. For another example, output channel 4 of the eighth card is identified as channel H4. So, to specify the H card channel 4 in such a command, it would be written as `FPAN:DChannel "H4"`.

## Signal Arguments

For commands that change channel parameters, there are two methods to identify the channel whose parameters are to be changed. The first method, described previously, is physical in nature; a signal is specified by identifying the card and channel whose parameter is to be set. The second method views channels in a logical manner. Using this logical view, a name is given to a channel; for example, a channel could be named "CLK" or "RE". Thereafter, the channel would be referred to as "CLK" rather than A1.

Signal names are used to indirectly access a channel's parameters and data. A signal can be either a pin or a bus. A bus is composed of two or more pins. A pin maps directly to a single channel, while a bus maps to two or more channels. A pin is mapped onto a channel using the `:PGEX:Chn:SIGNAL <pin>` command. A bus is defined as all pins that have a common name with different numerical suffixes. For example, `Addr0`, `Addr1`, `Addr2`, and `Addr3` are pin names with the common name `Addr`. Together, these four pins create a bus named `Addr[0:3]`. Signals can be accessed using either pin names, bus names, or both.

A signal is defined as follows:

- `<signal> ::= {<pin> | <bus>}`

A pin can be specified in the following ways:

- `<pin> ::=`

<code>&lt;name&gt;</code>	a single non-bus pin
<code>&lt;name&gt;&lt;bit&gt;</code>	one bit of a bus
<code>&lt;name&gt;[&lt;bit&gt;]</code>	one bit of a bus

Some examples are:

```
Clk
Addr0
Addr[0]
```

A bus can be specified in the following ways:

- `<bus> ::=`

<code>&lt;name&gt;[]</code>	an entire bus
<code>&lt;name&gt;[&lt;msb&gt;:&lt;lsb&gt;]</code>	bus with bit order
<code>&lt;name&gt;[&lt;msb&gt;..&lt;lsb&gt;]</code>	bus with bit order

Some examples are:

```
Addr[]
Addr[0:3]
Addr[0..3]
Addr[3:0]
Addr[3..0]
```

The symbols used above are defined in the following table.

Symbol	Meaning
<name>	A <Qstring> that cannot be terminated by a decimal. The maximum length is six characters including <bit>.
<bit>	Bit number, in <NR1> form
<msb>	Most significant bit, in <NR1> form
<lsb>	Most significant bit, in <NR1> form

### Vector Data

Vector data can be input or output using either the physical view or the logical view of the HFS 9000. Using the physical view, :PGENx:CHn:DATA and :PGENx:CHn:BDATA are the commands used to download and upload data. If you use the logical view, the :SIGNAL:DATA, :SIGNAL:BDATA, :VECTOR:IOF, :VECTOR:DATA:, VECTOR:BIOF, and :VECTOR:BDATA are the commands to use.

Symbol	Meaning
<radix>	The data radix: {<bin> <oct> <hex>}
<address>	Data address: {<NR1> <bin> <oct> <hex>]}
<constant>	Data constant: {<NR1> <bin> <oct> <hex>]}
<count>	Data count: {<NR1> <bin> <oct> <hex>]}
<binary byte>	Binary data byte: {<NR1> <bin> <oct> <hex>]}
<ascii data>	ASCII encoded data: <Qstring>
<binary data>	Binary encoded data block: <block>
<bin>	Binary encoded number: #B{0 1}...
<oct>	Octal encoded number: #Q{0 1 2 3...7}...
<hex>	Hexadecimal encoded number: #H{0 1 2 3...F}...

## Data Formats

Data can be sent to or read from the HFS 9000 in either ASCII or binary format.

### ASCII Data Format

To provide for interfacing to CAD workstations and present human readable vectors, several commands accept ASCII formatted data. These are:

- :PGEN<x>:CH<n>:DATA
- :SIGNAL:DATA
- :VECTOR:IOFORMAT
- :VECTOR:DATA

These commands accept data as quoted strings, for example: "11011100", or "FE4210D". See each command for specific information on formatting the data.

### Binary Data Format

To facilitate fast downloading and uploading of data, several commands which use binary formatted data are provided. These are:

- :PGEN<x>:CH<n>:BDATA
- :SIGNAL:BDATA
- :VECTOR:BIOFORMAT
- :VECTOR:BDATA

To correctly use these commands, the binary data must be formatted correctly. The format used is based on the internal memory structure of the Data Generator cards.

To convert an ASCII formatted string into a binary formatted block, each byte of data must be reversed in bit order. Consider the following command (placed on two lines for ease of reading):

```
:SIGNAL:DATA "Data0",0,40,  
"1000001001000010110000100010001010100010"
```

Translating this data to binary form would result in this command:

```
:SIGNAL:DATA "Data0",0,40,#15ABCDE
```

where:

A = binary 0100 0001, which is the reverse of 1000 0010

B = binary 0100 0010, which is the reverse of 0100 0010

C = binary 0100 0011, which is the reverse of 1100 0010

D = binary 0100 0100, which is the reverse of 0010 0010

E = binary 0100 0101, which is the reverse of 1010 0010

## Syntax Diagrams

The syntax diagrams in this manual use the following symbols and notation:

- Circles and ovals contain literal elements that must be sent exactly as shown. Command and query names are abbreviated to the minimum required spelling.
- Boxes contain the defined elements described earlier in this section, such as <NRf> or <QString>.
- Elements are connected by arrows that show the allowed paths through the diagram, and thus the orders in which the elements can be sent. Parallel paths show that one and only one of the paths must be taken. A path around a group of elements shows that those elements are optional. Loops show elements that can be repeated.

Figure 3–7 shows the structure of a few typical syntax diagrams.

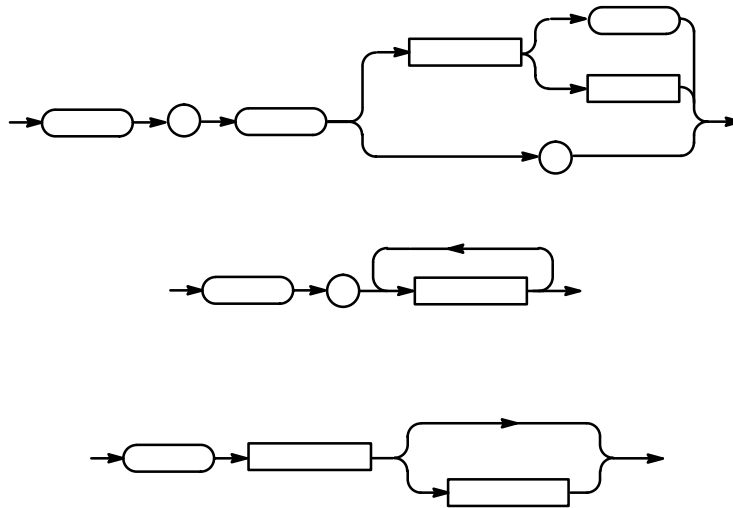

Figure 3–7: Typical Syntax Diagrams

# Commands

HFS 9000 commands fall into two main groups: Common Commands and Device Commands. The commands follow Tektronix Standard Codes and Formats 1989.

Most of these commands can be used either as set commands or queries. However, some commands can only be used to set: these have the words “No Query Form” included with the command name. Other commands can only be used to query: these have a question mark appended to the header and include the words “Query Only” in the command name.

Headers, mnemonics, and arguments are usually spelled out fully in text, with the minimum required spelling shown in upper case. For example, to use the command AMPLitude you must enter at least AMPL. The examples in this manual use the abbreviated forms.

## Common Commands and Queries

Several commands and queries used with the HFS 9000 are common to all devices on the GPIB bus. These commands and queries are defined by IEEE Std. 488.2-1987 and Tek Standard Codes and Formats 1989 as useful across all instruments in a GPIB system. These commands and queries may also be used in an RS-232-C system to control the HFS 9000.

Table 3–4 lists the Common Commands supported by the HFS 9000. Complete descriptions of these commands appear in an alphabetical listing of commands later in this section.

**Table 3–4: Commands Common to All GPIB Devices**

Header	Full Command Name
ALLEV?	All Events
*CLS	Clear Status
DESE	Device Event Status Enable
*ESE	Standard Event Status Enable
*ESR?	Standard Event Status Register
EVENT?	Event
EVMSG?	Event Message
FACTORY	Factory Reset
HEADER	Header

**Table 3–4: Commands Common to All GPIB Devices (Cont.)**

Header	Full Command Name
*IDN?	Identification
*LRN?	Learn Device Setup
*OPC	Operation Complete
*OPT?	Optional Identification
*PSC	Power-On Status Clear
PURGE	Purge
*RCL	Recall
*RST	Reset
*SAV	Save
*SRE	Service Request Enable
*STB?	Read Status Byte
*TRG	Trigger
*TST?	Self-Test
VERBOSE	Verbose
*WAI	Wait To Continue

## Device Commands and Queries

Device commands and queries are specific to the HFS 9000, and are defined in this manual. These commands and queries may be used by GPIB and RS-232-C systems to control the HFS 9000.

Table 3–5 lists the device commands and command parameters supported by the HFS 9000. Complete descriptions of these commands appear in the alphabetical listing of commands that immediately follows this table.

**Table 3–5: HFS 9000 Device Commands and Parameters**

Header	Full Command Name
ALIAS:CATALOG?	Alias Catalog
ALIAS:DEFINE	Alias Define
ALIAS:DELETE:ALL	Delete All Aliases
ALIAS:DELETE:NAME	Delete Named Alias
ALIAS:STATE	Turn the alias state on and off
CAL:CID	Card ID

Table 3-5: HFS 9000 Device Commands and Parameters (Cont.)

Header	Full Command Name
CAL:CONStant?	Calibration Constant
FPAN:ADVance	Front Panel Auto Advance Direction (HFS 9DG1 and HFS 9DG2 cards only)
FPAN:BEND	Front Panel Block End Address (HFS 9DG1 and HFS 9DG2 cards only)
FPAN:BHOLd	Front Panel Block Hold (HFS 9DG1 and HFS 9DG2 cards only)
FPAN:BSIZe	Front Panel Block Size (HFS 9DG1 and HFS 9DG2 cards only)
FPAN:BStart	Front Panel Block Start Address (HFS 9DG1 and HFS 9DG2 cards only)
FPAN:CONStant	Front Panel Constant Value (HFS 9DG1 and HFS 9DG2 cards only)
FPAN:COPIes	Front Panel Copies Value (HFS 9DG1 and HFS 9DG2 cards only)
FPAN:CORDer	Front Panel Channel Display Order
FPAN:DCHannel	Front Panel Displayed Channel
FPAN:DITem	Front Panel Displayed Item
FPAN:DMENu	Front Panel Displayed Menu
FPAN:DNCHannel	Front Panel Destination Channel (HFS 9DG1 and HFS 9DG2 cards only)
FPAN:DNSignal	Front Panel Destination Signal (HFS 9DG1 and HFS 9DG2 cards only)
FPAN:DNStart	Front Panel Destination Start Address (HFS 9DG1 and HFS 9DG2 cards only)
FPAN:DSEtting	Front Panel Displayed Setting
FPAN:DSIGnal	Front Panel Display Signal
FPAN:DVEctor	Front Panel Display Vector (HFS 9DG1 and HFS 9DG2 cards only)
FPAN:FSCale	Front Panel Fill Scale (HFS 9DG1 and HFS 9DG2 cards only)
FPAN:KEY	Front Panel Key
FPAN:KRESolution	Front Panel Knob Resolution
FPAN:MESSage	Front Panel Message
FPAN:MEthod	Front Panel Fill Method (HFS 9DG1 and HFS 9DG2 cards only)
FPAN:SORDER	Front Panel Signal Display Order



**Table 3–5: HFS 9000 Device Commands and Parameters (Cont.)**

Header	Full Command Name
FPAN:VRADix	Front Panel Vector Radix (HFS 9DG1 and HFS 9DG2 cards only)
PGEN<x>:CH<n>:AMPLitude	Pulse Generator Amplitude
PGEN<x>:CH<n>:BDATA	Pulse Generator Binary Data Input/Output
PGEN<x>:CH<n>:BDATA:FILL	Pulse Generator Binary Data Fill
PGEN<x>:CH<n>:CDElay	Pulse Generator Channel Delay
PGEN<x>:CH<n>:COUPut	Pulse Generator Complement Output
PGEN<x>:CH<n>:CVIew	Pulse Generator Channel View
PGEN<x>:CH<n>:DATA	Pulse Generator Data Input/Output (Binary ASCII) (HFS 9DG1 and HFS 9DG2 cards only)
PGEN<x>:CH<n>:DATA:COPI	Pulse Generator Data Copy (HFS 9DG1 and HFS 9DG2 cards only)
PGEN<x>:CH<n>:DATA:SWAP	Pulse Generator Data Swap (HFS 9DG1 and HFS 9DG2 cards only)
PGEN<x>:CH<n>:DCYCLe	Pulse Generator Duty Cycle
PGEN<x>:CH<n>:DRADix	Pulse Generator Data Radix (HFS 9DG1 and HFS 9DG2 cards only)
PGEN<x>:CH<n>:HIGH	Pulse Generator Level High
PGEN<x>:CH<n>:HLIMit	Pulse Generator High Limit
PGEN<x>:CH<n>:LDElay	Pulse Generator Leading Delay
PGEN<x>:CH<n>:LHOLd	Pulse Generator Leading Hold
PGEN<x>:CH<n>:LIMI	Pulse Generator Limit State
PGEN<x>:CH<n>:LLIMI	Pulse Generator Low Limit
PGEN<x>:CH<n>:LOW	Pulse Generator Level Low
PGEN<x>:CH<n>:LVIew	Pulse Generator Level View
PGEN<x>:CH<n>:OFFSet	Pulse Generator Offset
PGEN<x>:CH<n>:OUTPut	Pulse Generator Output
PGEN<x>:CH<n>:PHASe	Pulse Generator Phase
PGEN<x>:CH<n>:POLarity	Pulse Generator Polarity
PGEN<x>:CH<n>:PRATe	Pulse Generator Pulse Rate
PGEN<x>:CH<n>:SIGNal	Pulse Generator Signal Name
PGEN<x>:CH<n>:TDElay	Pulse Generator Trailing Delay
PGEN<x>:CH<n>:THOLd	Pulse Generator Trailing Hold
PGEN<x>:CH<n>:TINPut	Pulse Generator Transducer Input

**Table 3-5: HFS 9000 Device Commands and Parameters (Cont.)**

Header	Full Command Name
PGEN<x>:CH<n>:TRANSition	Pulse Generator Transition (HFS 9PG2 and HFS 9DG2 cards only)
PGEN<x>:CH<n>:TYPE	Pulse Generator Signal Type
PGEN<x>:CH<n>:WIDTH	Pulse Generator Width
RS232:BAUD	RS-232-C Baud Rate
RS232:DElay	RS-232-C Delay
RS232:ECHO	RS-232-C Echo
RS232:EOL	RS-232-C End-Of-Line
RS232:FLAGging	RS-232-C Flaggging
RS232:PARity	RS-232-C Parity
RS232:SBITs	RS-232-C Stop Bits
SIGna1:<parameter>	Signal Parameter
SIGna1:BDATA	Signal Binary Data Input/Out (HFS 9DG1 and HFS 9DG2 cards only)
SIGna1:BDATA:FILL	Signal Binary Data Fill (HFS 9DG1 and HFS 9DG2 cards only)
SIGna1:CVIew	Signal Channel View
SIGna1:DATA	Signal Data Input/Out (HFS 9DG1 and HFS 9DG2 cards only)
SIGna1:DATA:COPI	Signal Data Copy (HFS 9DG1 and HFS 9DG2 cards only)
SIGna1:DATA:SWAP	Signal Data Swap (HFS 9DG1 and HFS 9DG2 cards only)
SIGna1:DRADix	Signal Data Radix (HFS 9DG1 and HFS 9DG2 cards only)
SIGna1:TYPE	Signal Type
TBAS:COUNT	Time Base Count
TBAS:FREQuency	Time Base Frequency
TBAS:MODE	Time Base Mode
TBAS:PERiod	Time Base Period
TBAS:PLIN:INPut	Time Base Phase Lock In Input
TBAS:PVIEw	Time Base Period View
TBAS:RUN	Time Base Trigger Run
TBAS:TIN:INPut	Time Base Trigger In Input
TBAS:TIN:LEVe1	Time Base Trigger In Level

**Table 3–5: HFS 9000 Device Commands and Parameters (Cont.)**

<b>Header</b>	<b>Full Command Name</b>
TBAS:TIN:SLOPe	Time Base Trigger In Slope
TBAS:TIN:TRIGger	Time Base Trigger Generation
TBAS:TOUT:PERiod	Time Base Trigger Out Period
TBAS:TOUT:PRETrigger	Time Base Trigger Out Pretrigger
VECTor:BDATA	Vector Binary Data Input/Output (HFS 9DG1 and HFS 9DG2 cards only)
VECTor:BIOFormat	Vector Binary Input/Output Format (HFS 9DG1 and HFS 9DG2 cards only)
VECTor:DATA	Vector Data Input/Output (HFS 9DG1 and HFS 9DG2 cards only)
VECTor:END	Vector End Address (HFS 9DG1 and HFS 9DG2 cards only)
VECTor:IOFormat	Vector Input/Output Format (HFS 9DG1 and HFS 9DG2 cards only)
VECTor:LOOP	Vector Loop Address (HFS 9DG1 and HFS 9DG2 cards only)
VECTor:START	Vector Start Address (HFS 9PG2 and HFS 9DG2 cards only)

## ALIAS:CATALOG? (Query Only)

The ALIAS:CATALOG? query returns the currently defined alias labels.

**Related Commands** ALIAS:DEFINE, ALIAS:DELETE, FACTORY.

**Syntax** ALIAS:CATALOG?

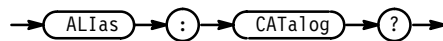

**Examples** ALI:CAT?

might return the string "SETUP1", "PULSE1", "DEFAULT", showing that there are currently 3 aliases named SETUP1, PULSE1, and DEFAULT. If the query returns the string "", no aliases are defined.

## ALIAS:DEFINE

The ALIAS:DEFINE command assigns a sequence of program messages to an alias label. These messages are then substituted for the alias whenever it is received as a command or query. The ALIAS:DEFINE? query returns the definition of a selected alias.

**Related Commands** ALIAS:CATALOG?, ALIAS:DELETE, FACTORY.

**Syntax** ALIAS:DEFINE <QString><Separator>{ <QString> | <Block> }  
 ALIAS:DEFINE? <QString>

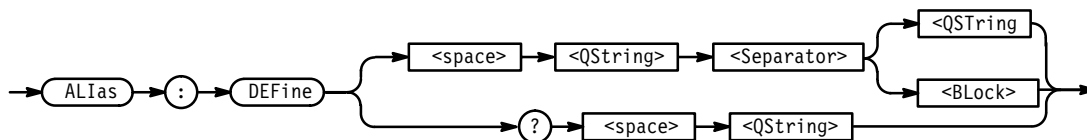

**Arguments** The first <QString> is the alias label. This label cannot be a command name. (Reserved command names are listed in Appendix C: Interface Specifications.) Labels must start with a letter. Labels can contain only letters, numbers, and underscores; other characters are not allowed.

The second <QString> or <Block> is a complete sequence of program messages. The messages must be separated by semicolons. Partial set commands or queries are not allowed and will cause an error when the alias label is received.

---

**NOTE.** Attempting to give two aliases the same name causes an execution error. To give a new alias the name of an existing alias, you must first delete the existing alias.

---

**Examples**    `ALI:DEF "PULSE_QRY","PGENA:CH1:LDELAY?;WIDTH?"`  
 creates an alias called PULSE\_QRY. Whenever the HFS 9000 receives PULSE\_QRY, it will replace PULSE\_QRY with the string PGENA:CH1:LDELAY?;WIDTH?

`ALI:DEF? "PULSE_QRY"`  
 returns the definition of the alias PULSE\_QRY, which is the string PGENA:CH1:LDELAY?;WIDTH?. If the query returned the string #10, this would show that no alias named PULSE\_QRY exists.

## ALIAS:DELETE:ALL (No Query Form)

The ALIAS:DELETE:ALL command deletes all existing aliases.

**Related Commands**    ALIAS:CATALOG?, ALIAS:DEFINE, FACTORY.

**Syntax**    ALIAS:DELETE:ALL



## ALIAS:DELETE:NAME (No Query Form)

The ALIAS:DELETE:NAME command removes a selected alias.

**Related Commands**    ALIAS:CATALOG?, ALIAS:DEFINE, FACTORY.

**Syntax**    ALIAS:DELETE:NAME <QString>



**Arguments**    <QString> is the name of the alias you want to remove. Using ALIAS:DELETE:NAME without specifying an alias causes an execution error.

**Examples**     ALIAS:DELETE:NAME "SETUP3"  
                       removes the alias called SETUP3.

## ALIAS:STATE

The ALIAS:STATE command turns aliases on or off. This command is identical to the ALIAS command

**Related Commands**     ALIAS, FACTORY.

**Syntax**     ALIAS:STATE { OFF | ON | <NR1> }  
                   ALIAS:STATE?

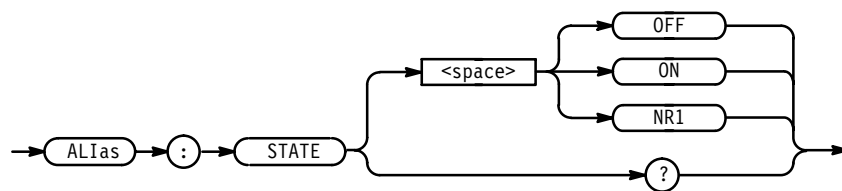

**Arguments**     OFF or <NR1> = 0 turns alias expansion off. If a defined alias is sent when ALIAS:STATE is OFF, a command error will be generated.

ON or <NR1> = 1 turns alias expansion on. When a defined alias is received, the specified command sequence is substituted for the alias and executed.

**Examples**     ALIAS:STATE OFF  
                       turns the command alias feature off.

ALIAS:STATE?  
                       returns 0 when alias mode is off.

## ALLEV? (Query Only)

Causes the HFS 9000 to return all events and their messages, and removes the returned events from the Event Queue. The messages are separated by commas. Use the \*ESR? query to enable the events to be returned. For a complete discussion of the use of the Event Queue registers, see page 3–129. This command is similar to repeatedly sending \*EVMsg? queries to the instrument.

**Related Commands**     \*CLS, DESE, \*ESE, \*ESR?, EVENT?, EVMsg?, \*SRE, \*STB?

**Syntax** ALLEv?



**Examples** ALLEv?

might return the string ALLEV 520, "Value too large, decreased to maximum; -PERiod-5.0e +02",420,"Query UNTERMINATED; "

## CAL:CONStant? (Query Only)

The CAL:CONStant? query returns selected calibration constants for a designated board.

**Syntax** CAL:CONStant? <QString><Separator><NRf>

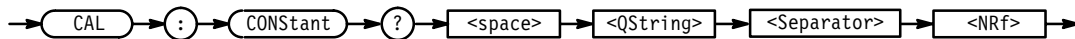

**Arguments** <QString> specifies the card to be queried. Valid strings are "CPU", "TB", "A", "B", "C", "D", "E", "F", "G", "H", and "I". These query the CPU card, Time Base card, and Pulse Generator cards A through I, respectively.

<NRf> specifies the calibration constant to be queried. Calibration constant zero contains the number of calibration constants used by the specified card.

**Examples** CAL:CONS? "CPU",0

returns the number of calibration constants, including calibration constant 0, available for the CPU card.

CAL:CONS? "A",12

returns the current value of calibration constant 12 for pulse generator card A.

CAL:CONS? "TB",8

returns the current value of calibration constant 8 for the Time Base card.

## CAL:CID

CAL:CID (card ID) sets and queries the ID of a specified card.

**Syntax** CAL:CID <QString><Separator><QString>

CAL:CID? <QString>

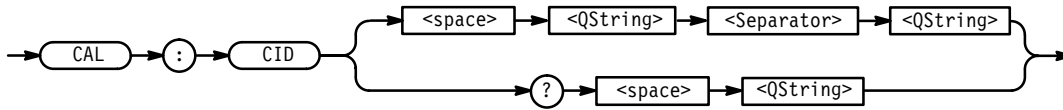

**Arguments** The first <QString> specifies the card to be set or queried. Valid strings are "CPU", "TB", "A", "B", "C", "D", "E", "F", "G", "H", and "I". These query the CPU card, Time Base card, and Pulse Generator cards A through I, respectively.

The second <QString> sets the card ID (≤10 characters) for the specified card.

**Examples** CAL:CID "CPU", "B010100"  
sets the CPU card ID.

CAL:CID "TB", "B010125"  
sets the Time Base card ID.

CAL:CID "A", "PGEN V1.0"  
sets the A pulse generator card ID.

CAL:CID? "CPU"  
returns the CPU card ID.

### \*CLS (No Query Form)

The \*CLS (Clear Status) command clears the HFS 9000 status data structures, and puts the HFS 9000 in the Operation Complete Command Idle State and in the Operation Complete Query Idle State. While in these states the HFS 9000 has nothing in its buffers and does not execute commands or queries.

**Related Commands** DESE, \*ESE, \*ESR, EVENT?, EVMSG?, \*SRE, \*STB.

**Syntax** \*CLS

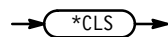

The \*CLS command clears the following:

- the Event Queue
- the Standard Event Status Register (SESR)
- the Status Byte Register (except the MAV bit; see below)



If the \*CLS command immediately follows an <EOI>, the Output Queue and MAV bit (Status Byte Register bit 4) are also cleared. MAV indicates information is in the output queue. DCL will clear the output queue and MAV. \*CLS does not clear the output queue or MAV. (A complete discussion of these registers and bits, and of event handling in general, is on page 3–129.)

## DESE

The DESE (Device Event Status Enable) command sets and queries the bits in the Device Event Status Enable Register (DESER). The DESER prevents events from being reported to the Standard Event Status Register (SESR), and from being entered into the Event Queue. For a complete discussion of the use of these registers, see page 3–129.

**Related Commands**    \*CLS, \*ESE, \*ESR, EVENT?, EVMSG?, \*SRE, \*STB.

**Syntax**    DESE <NRf>

DESE?

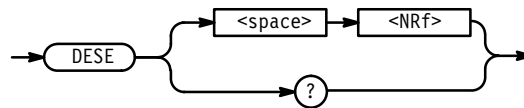

**Arguments**    <NRf> is a value in the range from 0 to 255. The binary bits of the DESER are set according to this value. For example, DESE 209 sets the DESER to the binary value 11010001 (that is, the first bit in the register is set to 1, the second bit to 1, the third bit to 0, etc.).

The power-on default for DESER is all bits set if \*PSC is 1. If \*PSC is 0, the DESER maintains its value through a power cycle.

---

**NOTE.** Setting the DESER and the ESER to the same value allows only those codes to be entered into the Event Queue and summarized on the ESB bit (bit 5) of the Status Byte Register. Use the \*ESE command to set the ESER. A complete discussion of event handling is on page 3–129.

---

**Examples**    DESE 209  
                   sets the DESER to binary 11010001, which enables the PON, URQ, EXE, and OPC bits.

DESE?

might return the string :DESE 186, showing that the DESER contains the binary value 10111010.

**\*ESE**

The \*ESE (Event Status Enable) command sets and queries the bits in the Event Status Enable Register (ESER). The ESER prevents events from being reported to the Status Byte Register (SBR). For a complete discussion of the use of these registers, see page 3–129.

**Related Commands**

\*CLS, DESE, \*ESR, EVENT?, EVMSG? \*SRE, \*STB.

**Syntax**

\*ESE <NRf>

\*ESE?

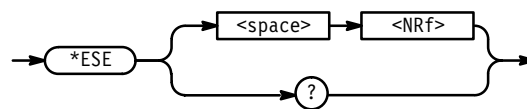

**Arguments**

<NRf> is a value in the range from 0 through 255. The binary bits of the ESER are set according to this value.

The power-on default for ESER is 0 if \*PSC is 1. If \*PSC is 0, the ESER maintains its value through a power cycle.

---

**NOTE.** Setting the DESER and the ESER to the same value allows only those codes to be entered into the Event Queue and summarized on the ESB bit (bit 5) of the Status Byte Register. Use the DESE command to set the DESER. A complete discussion of event handling is on page 3–129.

---

**Examples**

\*ESE 209

sets the ESER to binary 11010001, which enables the PON, URQ, EXE, and OPC bits.

\*ESE?

might return the string \*ESE 186, showing that the ESER contains the binary value 10111010.

## \*ESR? (Query Only)

The \*ESR? (Event Status Register) query returns the contents of the Standard Event Status Register (SESR). \*ESR? also clears the SESR since reading the SESR clears it. For a complete discussion of the use of these registers, see page 3–129.

**Related Commands** \*CLS, DESE, \*ESE, EVENT?, EVMSG?, \*SRE, \*STB.

**Syntax** \*ESR?



**Examples** \*ESR?  
 might return the value 213, showing that the SESR contains binary 11010101.

## EVENT? (Query Only)

The EVENT? query returns from the Event Queue an event code that provides information about the results of the last \*ESR? read. EVENT? also removes the returned value from the Event Queue. A complete discussion of event handling is on page 3–129.

**Related Commands** \*CLS, DESE, \*ESE, \*ESR?, EVMSG?, \*SRE, \*STB.

**Syntax** EVENT?



**Examples** EVENT?  
 might return the response :EVENT 110, showing that there was an error in a command header.

## EVMSG? (Query Only)

The EVMSG? query removes from the Event Queue a single event code associated with the results of the last \*ESR? read, and returns the event code along with an explanatory message. A complete discussion of event handling is on page 3–129.

**Related Commands** \*CLS, DESE, \*ESE, \*ESR?, EVENT?, \*SRE, \*STB.

**Syntax** EVMSG?



**Examples** EVMSG?  
 might return the message :EVMSG 110,"Command header error".

## FACTORY (No Query Form)

The FACTORY command resets the HFS 9000 to its factory default settings, and purges all defined aliases and stored settings. This performs the same function as the **Factory** item in the front-panel Save/Recall menu.

**Related Commands** DESE, \*ESE, FPAN, HEADER, PGEN<x>, \*PSC, \*RST, \*SRE, TBAS, VERBOSE.

**Syntax** FACTORY



The FACTORY command does the following:

- Puts the HFS 9000 in the Operation Complete Command Idle State.
- Puts the HFS 9000 in the Operation Complete Query Idle State.
- Clears the Event Status Enable Register (equivalent to the command \*ESE 0).
- Clears the Service Request Enable Register (equivalent to the command \*SRE 0).
- Sets the Device Event Status Enable Register to all-enabled (equivalent to the command DESE 255).
- Sets the Power-on status clear flag to TRUE (equivalent to the command \*PSC 1).
- Sets the Response Header Enable State to TRUE (equivalent to the command HEADER 1).

- Sets the Verbose Header State to TRUE (equivalent to the command VERBOSE 1).
- Purges all aliases (equivalent to the command ALIAS:DELETE:ALL).
- Purges all stored settings.
- Sets the front panel as shown in Table 3–6:

**Table 3–6: FACTORY Front Panel Settings**

Front Panel Parameter	Setting
FPAN:ADVance	RIGHT
FPAN:BEND	0
FPAN:BHOLD	BEND
FPAN:BSIZE	0
FPAN:BStart	0
FPAN:CONSTant	1
FPAN:COPIes	1
FPAN:CORDER	"A1", "A2", "A3", ...
FPAN:DITem	"Pulse Menu"
FPAN:DMENU	"Main Menu"
FPAN:DNChannel	"A1"
FPAN:DNStart	0
FPAN:DVECTOR	0
FPAN:FSCale	1
FPAN:METHod	CONSTANT
FPAN:KRESolution	COARSE
FPAN:DChannel	"A1"
FPAN:DSETting	1
FPAN:MESSAGE	" "
FPAN:VRADix	DEC

- Sets the time base as shown in Table 3–7:

**Table 3–7: FACTORY Time Base Settings**

Time Base Parameter	Setting
TBAS:MODE	AUTO
TBAS:PERiod	5ns
TBAS:COUNT	64
TBAS:PVIEW	PERIOD
TBAS:RUN	ON
TBAS:TIN:INPut	ON
TBAS:TIN:SLOPe	POSITIVE
TBAS:TIN:LEVe1	-1.3V
TBAS:PLIN:INPut	OFF
TBAS:TOUT:PERiod	1
TBAS:TOUT:PRETrigger	70 ns

- Sets each pulse generator channel as shown in Table 3–8:

**Table 3–8: FACTORY Pulse and Data Time Generator Settings**

Pulse Card Parameter	Setting
PGEN<x>:CH<n>:HIGH	All Cards -800mV
PGEN<x>:CH<n>:LOW	All Cards -1.8V
PGEN<x>:CH<n>:HLIMit	All Cards 0V
PGEN<x>:CH<n>:LLIMit	All Cards -2V
PGEN<x>:CH<n>:LDELay	All Cards 0s
PGEN<x>:CH<n>:DCYCLE	All Cards 50%
PGEN<x>:CH<n>:TRANSition	9PG1 200ps 9PG2 800ps 9DG1 200ps 9DG2 800ps
PGEN<x>:CH<n>:OUTPut	All Cards OFF
PGEN<x>:CH<n>:COUtput	All Cards OFF
PGEN<x>:CH<n>:LIMit	All Cards OFF
PGEN<x>:CH<n>:PRATe	All Cards NORMAL
PGEN<x>:CH<n>:LHOLd	All Cards LDELay

**Table 3–8: FACTORY Pulse and Data Time Generator Settings (Cont.)**

Pulse Card Parameter	Setting
PGEN<x>:CH<n>:THOLd	All Cards DCYCLE
PGEN<x>:CH<n>:LVIew	All Cards HIGH
PGEN<x>:CH<n>:POLarity	All Cards NORMAL
PGEN<x>:CH<n>:CDELay	All Cards 0s
PGEN<x>:CH<n>:SIGNal	All Cards ""
PGEN<x>:CH<n>:TYPE	All Cards PULSE
PGEN<x>:CH<n>:CVIEW	All Cards CHANNEL
PGEN<x>:CH<n>:DRADix	All Cards HEX

The FACTORY command does not alter the following:

- The state of the RS-232-C or GPIB (IEEE 488.1) interfaces.
- The selected GPIB address.
- Calibration data that affects device specifications.

## FPAN?

The FPAN (Front Panel) command operates or queries the front panel display and controls from the remote controller. The query FPAN? returns the values of all front panel parameters.

**Syntax** FPAN?



**Examples** FPAN?

might return the string :FPAN:DMEN "Main Menu";DIT "Pulse Menu";DCH "A1";DSET 1;KRES COAR.

## FPAN:ADVance

FPAN:ADVance (Auto Advance Direction) controls the direction of the auto advance function in the Data Edit menu. The cursor in the Data Edit menu can move either left and right or up and down.

**Syntax** FPAN:ADVance { DOWN | RIGHt }  
 FPAN:ADVance?

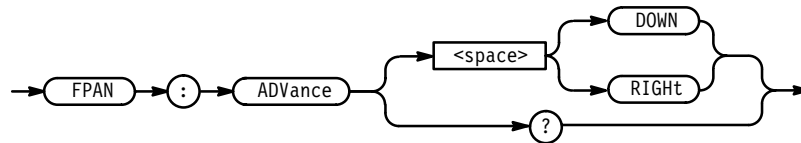

**Arguments** {DOWN|RIGHt} specifies the direction the cursor moves. This is implemented on the front panel by pressing the up/down arrow keys or the left/right arrow keys.

**Examples** FPAN:ADVANCE RIGHT  
 sets the auto advance direction to the right.

FPAN:ADVANCE?  
 returns the auto advance direction.

## FPAN:BEND

FPAN:BEND sets the block end address. The block end address is a parameter that is used by the **Fill Block with Method** and **Clear Block** items in the Data Fill menu.

**Syntax** FPAN:BEND <address>  
 FPAN:BEND?

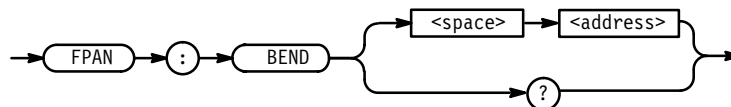

**Arguments** <address> specifies the address of the block end. Valid values for this parameter are 0 to 65535. The current value is displayed in the argument field of the **Block End** item in the front-panel Data Fill and Data Copy menus.

**Examples** FPAN:BEND 127  
 sets the block end address to 127.

FPAN:BEND?  
 returns the block end address.



## FPAN:BHOLD

FPAN:BHOLD (Block Hold) specifies whether the end of the block is controlled by the Block End value or the Block Size value. This performs the same functions as the **Block Size/Block End** item in the front-panel Data Fill and Data Copy menus.

**Syntax** FPAN:BHOLD { BEND | BSIZe }

FPAN:BHOLD?

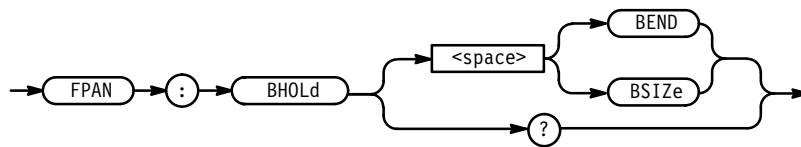

**Arguments** BEND specifies that the block end value establishes the end of the block.

BSIZe specifies that the block size value establishes the end of the block.

**Examples** FPAN:BSIZE  
sets the block end hold to size.

FPAN:BHOLD?  
returns the block hold setting.

## FPAN:BSIZe

FPAN:BSIZe (Set Block Size) sets the block size. The block size is a parameter that is utilized by the **Fill Block with Method** and **Clear Block** items in the Data Fill and Data Copy menus.

**Syntax** FPAN:BSIZe <NR1>

FPAN:BSIZe?

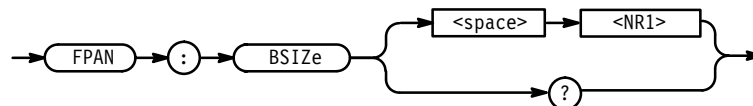

**Arguments** <NR1> specifies the block size. Valid values for this parameter are 1 to 65536. The block size value is displayed in the argument field of the **Block Size** item in the front-panel Data Fill and Data Copy menus.

**Examples**    FPAN:BSIZE 128  
                   sets the block size to 128.

                  FPAN:BSIZE?  
                   returns the block size.

## FPAN:BStart

FPAN:BStart (Block Start Address) sets the block start address. The block start address is a parameter that is used by the **Fill Block with Method** and **Clear Block** items in the Data Fill and Data Copy menus.

**Syntax**    FPAN:BStart <address>  
                   FPAN:BStart?

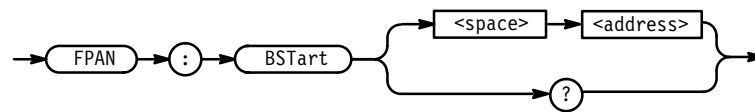

**Arguments**    <address> specifies the start address of the block. Valid values for this parameter are 0 to 65535. The current value is displayed in the argument field of the **Block Start** item in the front-panel Data Fill menu.

**Examples**    FPAN:BSTART 0  
                   sets the block start address to 0.

                  FPAN:BSTART?  
                   returns the block start address.

## FPAN:CONStant

FPAN:CONStant (Constant Value) sets the fill constant. This performs the same function as the **Constant** item in the front-panel Data Fill menu.

**Syntax**    FPAN:CONStant <constant>  
                   FPAN:CONStant?

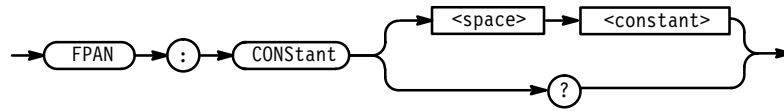

**Arguments** <constant> specifies the value assigned to the fill constant. The valid range for <constant> are dependent on the Data Radix. For a binary data radix, the valid range is 0–1111111111. For an octal data radix, the valid range is 0–3777777777. For a hex data radix, the valid range is 0–FFFFFFFF. The value of this parameter is displayed in the argument field of the **Constant** item in the front-panel Data Fill menu.

**Examples** FPAN:CONSTANT #H00FF  
 sets the constant to hex 00FF.

FPAN:CONSTANT?  
 returns the constant value.

## FPAN:COPIes

FPAN:COPIes (Copies Value) specifies the Copies value. This performs the same function as the **Copies** item in the front-panel Data Fill menus.

**Syntax** FPAN:COPIes <NR1>  
 FPAN:COPIes?

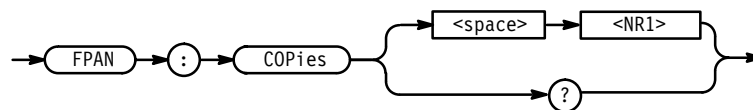

**Arguments** <NR1> specifies the Copies value. The valid range is 1–65535.

**Examples** FPAN:COPIES 20  
 sets the number of copies to 20.

FPAN:COPIES?  
 returns the copies value.

## FPAN:CORDer

FPAN:CORDer (Channel Display Order) controls the display order of channels. This performs the same function as the **Move Up/Down** item in the front-panel Signal menu.

**Syntax** FPAN:CORDer <channel>[ , <channel>... ]  
 FPAN:CORDer?

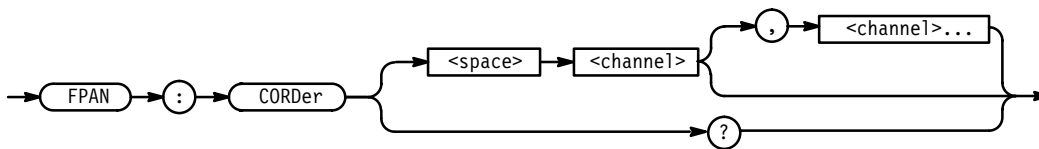

**Arguments** <channel>[<channel>...] specifies the new order in which channels should be displayed.

**Examples** FPAN:CORDER "A1", "A2", "B1", "B2", "C1", "C2"  
 sets the display order to the default order.

FPAN:CORDER "C2", "C1", "B2", "B1", "A2", "A1"  
 sets the display order to the reverse of the default.

FPAN:CORDER?  
 returns the channel display order.

## FPAN:DCHannel

FPAN:DCHannel (Displayed Channel) displays a selected channel or returns the displayed channel. This performs the same function as the **Channel** item in the front-panel Pulse, Levels, or Cal/Deskew menus.

**Syntax** FPAN:DCHannel <QString>  
 FPAN:DCHannel?

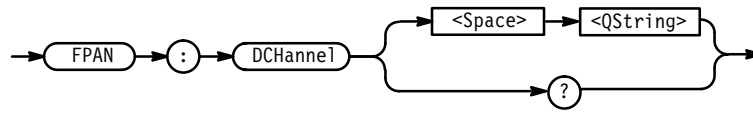

**Arguments** <QString> specifies the channel to display. Valid strings for this parameter are those displayed in the argument field of the **Channel** item in the front-panel Pulse, Levels, and Cal/Deskew menus.

**Examples** FPAN:DCH "A1"  
 sets the displayed channel to A1.

FPAN:DCH?  
 returns the displayed channel.

## FPAN:DITem

FPAN:DITem (Displayed Item) displays a selected item from the currently displayed menu or queries the displayed menu item. This performs the same function as selecting an item from a front-panel menu.

**Syntax** FPAN:DITem <QString>  
 FPAN:DITem?

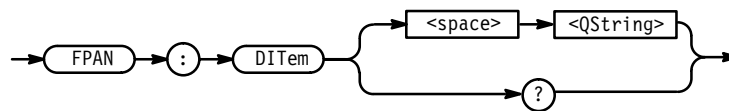

**Arguments** <QString> specifies the menu item to select. Valid strings are the menu item titles from the currently displayed menu (for example, "Width", "Period", "Slope", etc. for the Pulse menu). To change the displayed menu, use the FPAN:DMENU command.

**Examples** FPAN:DIT "Period"  
 displays the **Period** item.

FPAN:DIT "Width"  
 displays the **Width** item.

FPAN:DIT?  
 returns the currently displayed item.

## FPAN:DMENU

FPAN:DMENU (Displayed Menu) displays a selected menu or queries the displayed menu. This performs the same function as selecting a menu from the front-panel.

**Syntax** FPAN:DMENU <QString>  
 FPAN:DMENU?

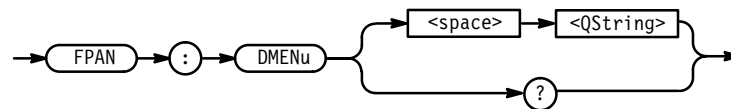

**Arguments** <QString> specifies the menu to display. Valid strings are the menu titles (including "Main Menu") from the Main Menu.

**Examples** FPAN:DMEN "Pulse"  
 selects the Pulse menu.

FPAN:DMEN "Time Base"  
 selects the Time Base menu.

FPAN:DMEN?  
 returns the currently displayed menu.

## FPAN:DNChannel

FPAN:DNChannel (Destination Channel) specifies the destination parameter of the **Swap Block with Dest** and **Copy Block to Dest** items in the front-panel Data Copy menu. This command performs the same function as the **Dest Chan** item in the front-panel Data Copy menu.

**Syntax** FPAN:DNChannel <channel>  
 FPAN:DNChannel?

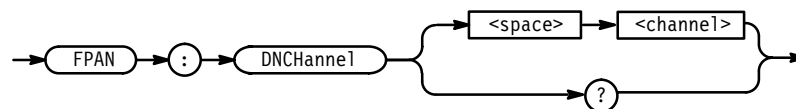

**Arguments** <channel> specifies the channel to which blocks of data are copied or with which they are swapped.

**Examples**    `FPAN:DNCHANNEL "C2"`  
                   sets the destination channel to C2.

`FPAN:DNCHANNEL?`  
                   returns the destination channel name.

## FPAN:DNSignal

FPAN:DNSignal (Destination Channel) specifies the destination parameter of the **Swap Block with Dest** and **Copy Block to Dest** items in the front-panel Data Copy menu. This command performs the same function as the **Dest Chan** item in the front-panel Data Copy menu.

**Syntax**    `FPAN:DNSignal <pin>`  
`FPAN:DNSignal?`

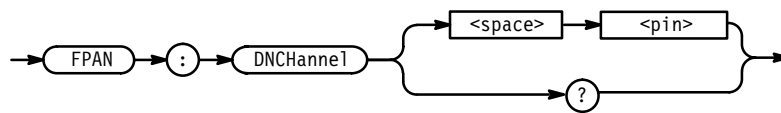

**Arguments**    `<pin>` specifies the signal to which blocks of data are copied or with which they are swapped.

**Examples**    `FPAN:DNSIGNAL "~WE"`  
                   sets the destination signal to ~WE.

`FPAN:DNSignal?`  
                   returns the destination signal.

## FPAN:DNStart

FPAN:DNStart (Destination Start Address) specifies the destination start address parameter of the **Swap Block with Dest** and **Copy Block to Dest** items in the front-panel Data Copy menu. This command performs the same function as the **Dest Start** item in the front-panel Data Copy menu.

**Syntax**    `FPAN:DNStart <address>`  
`FPAN:DNStart?`

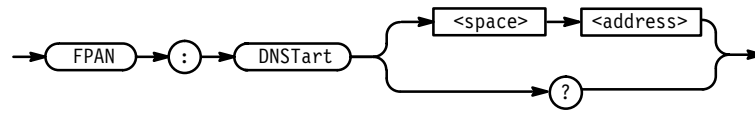

**Arguments** <address> specifies the start address to which blocks of data are copied or with which they are swapped.

**Examples** FPAN:DNSTART 0  
sets the destination start address to 0.

FPAN:DNStart?  
returns the destination start address.

## FPAN:DSEtting (Displayed Setting)

FPAN:DSEtting displays a selected save-recall setting number, or queries the displayed save-recall setting number. This performs the same functions as the **Setting** item in the front-panel Save/Recall menu.

**Syntax** FPAN:DSEtting <NRf>  
FPAN:DSEtting?

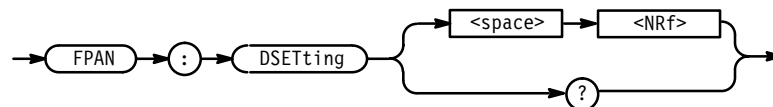

**Arguments** <NRf> is an integer in the range from 1 to 30. This integer specifies the save-recall setting to display.

**Examples** FPAN:DSET 5  
sets the displayed save-recall setting to 5.

FPAN:DSET?  
returns the displayed save-recall setting number.

## FPAN:DSIGNal

FPAN:DSIGNal (Display Signal) displays a signal. This command performs the same function as the **Channel** item in the front-panel Pulse, Levels, Signal, Vector, Data Fill, Data Copy, or Cal/Deskew menus.



**Syntax** FPAN:DSIGna1 <pin>

FPAN:DNSIGna1?

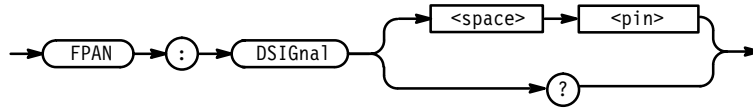

**Arguments** <pin> specifies the signal to display

**Examples** FPAN:DSIGNAL "~WE"  
sets the display signal to ~WE.

FPAN:DSIGNAL?  
returns the displayed signal.

## FPAN:DVEctor

FPAN:DVEctor (Display Vector) controls the currently displayed vector address. This command performs the same function as pressing SELECT when in the Data Edit menu.

**Syntax** FPAN:DVEctor <address>

FPAN:DVEctor?

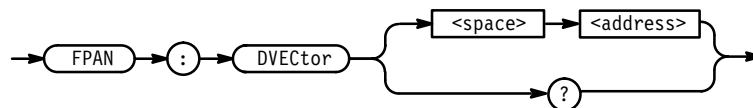

**Arguments** <address> specifies the vector address to display

**Examples** FPAN:DVECTOR 1000  
sets the displayed vector to 1000.

FPAN:DVECTOR?  
returns the displayed vector address.

## FPAN:FSCale

FPAN:FSCale (Fill Scale) sets the fill scale. This command performs the same function as the **Fill Scale** item in the front-panel Data Fill menus.

**Syntax** FPAN:FSCale <NR1>

FPAN:FSCale?

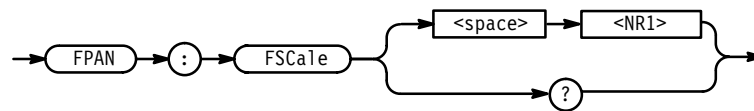

**Arguments** <NR1> specifies the fill scale. The range for fill scale is 1 to 65535.

**Examples** FPAN:FSCALE 4  
sets the fill scale to 4.

FPAN:FSCALE?  
returns the current fill scale.

## FPAN:KEY

FPAN:KEY simulates front panel button presses. These simulated button presses go into the same input queue as button presses coming from the front panel.

---

**NOTE.** Simulated button presses are NOT executed sequentially with other remote commands, but are executed sequentially with front panel button presses. Front-panel button execution and remote command execution are asynchronous.

All front-panel button presses and remote FPAN:KEY simulated presses go into an FIFO queue that holds the last 20 executed button presses. FPAN:KEY? queries the oldest button press out of this FIFO queue.

---

**Syntax** FPAN:KEY <QString><Separator><QString>[<Separator><NRf>]

FPAN:KEY?

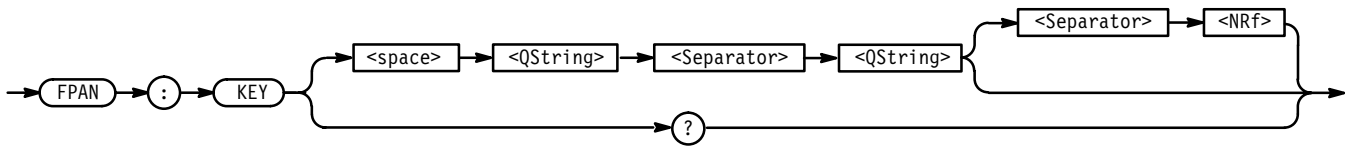

**Arguments** The first <QString> selects the section of the HFS 9000 that contains the button. Valid strings are: "FP", "A1", "A2", "B1", etc.

The second <QString> specifies the button to press. Valid strings are the labels of the buttons. Some exceptions are noted in Table 3–9, particularly the operation of the equivalents for the channel card **OUTPUT** and **OUTPUT** buttons. Upper or lower case letters may be used. The capitalization shown in Table 3–9 shows what is returned by query commands.

<NRf> selects the number of clicks to turn the knob (default value = 1). Use negative values to turn the knob counter-clockwise and positive values to turn the knob clockwise.

**Table 3–9: FPAN:KEY Front Panel Key Equivalents**

Second <QString>	Front Panel Entity
"0" through "9"	Digit buttons 0 through 9
"m" or "A"	m milli ( $\times 10^{-3}$ ) button or hexadecimal A
"G" or "B"	G giga ( $\times 10^9$ ) button or hexadecimal B
"u" or "C"	$\mu$ (micro) ( $\times 10^{-6}$ ) button or hexadecimal C
"M" or "D"	M mega ( $\times 10^6$ ) button or hexadecimal D
"n" or "E"	n nano ( $\times 10^{-9}$ ) button or hexadecimal E
"k" or "F"	k kilo ( $\times 10^3$ ) button or hexadecimal F
"X" or "p"	p pico ( $\times 10^{-12}$ ) button or logic "don't care" X button
"."	Decimal point . button
" +/-"	Change sign +/- button
"Backspace"	BACKSPACE button
"Enter"	ENTER button
"Main Menu"	MAIN MENU button
"Select"	SELECT button
"Up"	Up arrow button
"Down"	Down arrow button
"Left"	Left arrow button
"Right"	Right arrow button
"Next Channel"	NEXT CHANNEL button

**Table 3-9: FPAN:KEY Front Panel Key Equivalents (Cont.)**

Second <QString>	Front Panel Entity
"Prev Channel"	PREVIOUS CHANNEL button
"Undo"	UNDO button
"Manual Trigger"	MANUAL TRIGGER button
"Srq"	SRQ button
"Fine"	FINE button
"Knob"	The knob (direction of turn and number of clicks determined by <Nrf> argument).
"Output On"	Turn on specified channel; equivalent to the <b>OUTPUT</b> button when the channel is off.
"Output Off"	Turn off specified channel; equivalent to the <b>OUTPUT</b> button when the channel is on.
"~Output On"	Turn on specified channel inverted output; equivalent to the <b>OUTPUT</b> button when the channel is off.
"~Output Off"	Turn off specified channel inverted output; equivalent to the <b>OUTPUT</b> button when the channel is on.

**Examples**

FPAN:KEY "FP", "6"

“presses” the front panel button “6”.

FPAN:KEY "FP", "Knob", -3 “turns” the knob 3 clicks counter-clockwise.

FPAN:KEY "A1", "Output On"

puts the channel A1 button “Output” in the ON position.

FPAN:KEY?

returns the oldest entry in a FIFO queue of the last 20 button presses or knob turns. If the FIFO queue is empty, the string FPAN:KEY "FP", "NONE" is returned.

## FPAN:KRESolution (Knob Resolution)

FPAN:KRESolution sets and queries the resolution of the front panel knob. This performs the same function as pressing the **Fine** button above the front-panel knob.

**Syntax** FPAN:KRESolution { COARse | FINE }

FPAN:KRESolution?

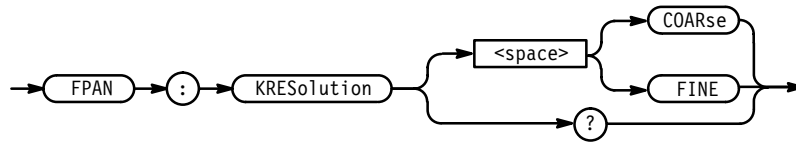

**Arguments** COARse sets the knob resolution to Coarse.  
 FINE sets the knob resolution to Fine.

**Examples** FPAN:KRES FINE  
 sets knob resolution to Fine.  
 FPAN:KRES?  
 returns the current knob resolution.

## FPAN:MESSage (No Query Form)

FPAN:MESSage sets a message that appears on the front panel.

**Syntax** FPAN:MESSage <QString>

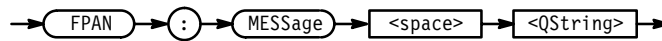

**Arguments** <QString> is the message to display on the front panel. Use an embedded line feed to create a message having two lines. Lines longer than the display width wrap onto the next line.

---

**NOTE.** To erase a message, send FPAN:MESS "".

---

**Examples** FPAN:MESS "Attach pulse channel A1 to test point 7."

## FPAN:METHod

FPAN:METHod sets the fill method. Note that this command does *not* fill a block with data; this command only specifies the method used to fill a block. The fill method is a parameter of the **Fill Block with Method** item in the Data Fill menu. This command performs the same function as the **Method** item in the front-panel Data Fill menus.

**Syntax** FPAN:MEthod { CONStant | INVert | CUP | CDOWn | RANDom }  
 FPAN:MEthod?

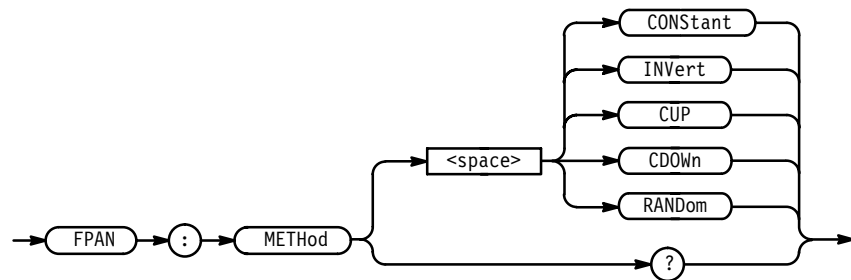

**Arguments** <CONStant> specifies that the block be filled with a constant (specified by the Constant menu item or :FPAN:CONSTant). <INVert> inverts the values in each vector. <CUP> counts up by starting with the constant value and then incrementing by 1. <CDOWn> counts down by starting with the constant value and then decrementing by 1. <RANDom> fills the block with random data.

**Examples** FPAN:METHOD RANDOM  
 sets the fill method to Random.  
 FPAN:METHOD?  
 returns the current fill method.

## FPAN:SORDER

FPAN:SORDER (Signal Display Order) specifies the order in which signals (channels named by PGEN<x>:CH<n>:SIGNAL <pin>) are displayed. This command performs the same function as the **Move Up/Down** item in the front-panel Signal menu.

**Syntax** FPAN:SORDER <signal>[ , <signal>... ]  
 FPAN:SORDER?

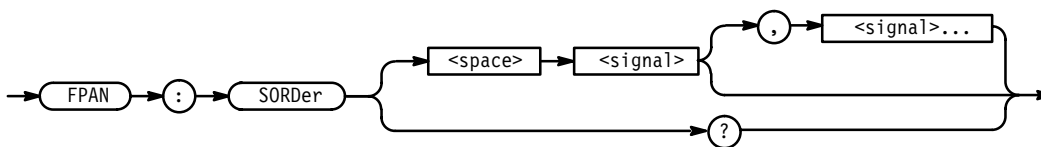

**Arguments** <signal> is the name of the channel.

**Examples**    `FPAN:SORDER "~WE", "A[0:7]", "D[3:0]"`  
                   sets the signal display order as indicated.

`FPAN:SORDER?`  
                   returns the current signal display order.

## FPAN:VRADix

FPAN:VRADix controls how vector addresses are displayed on the front panel. This command performs the same function as the **Vec Radix** item in the front-panel Data Fill and Data Copy menus.

**Syntax**    `FPAN:VRADix { OCT | DEC | HEX }`  
`FPAN:VRADix?`

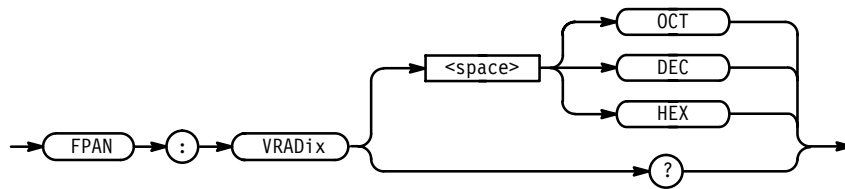

**Arguments**    `<OCT>` specifies an octal vector radix. `<DEC>` specifies a decimal vector radix. `<HEX>` specifies a hexadecimal vector radix.

**Examples**    `FPAN:VRADIX HEX`  
                   sets the vector radix to hexadecimal.

`FPAN:VRADIX?`  
                   returns the current vector radix.

## HEADER

The **HEADER** command sets and queries the Response Header Enable State that causes the HFS 9000 to either include or omit headers on query responses. This command does not affect IEEE 488.2 Common Commands (those starting with an asterisk).

**Related Commands**    `VERBOSE.`

**Syntax**    `HEADER { ON | OFF | <Nrf> }`

HEADER?

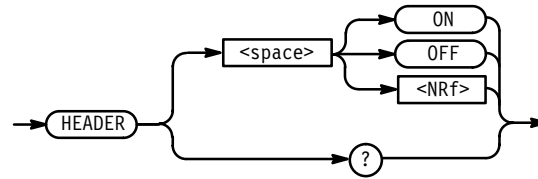

**Arguments** ON or <NRf> ≠ 0 sets the Response Header Enable State to TRUE. This causes the HFS 9000 to include headers on applicable query responses. You can then use the query response as a command.

OFF or <NRf> = 0 sets the Response Header Enable State to FALSE. This causes the HFS 9000 to omit headers on query responses, so that only the argument is returned.

- Examples**
- HEADER OFF  
causes the HFS 9000 to omit headers from query responses.
  - HEADER 1  
causes the HFS 9000 to include headers on applicable query responses.
  - HEADER?  
might return the value 1, showing that the Response Header Enable State is TRUE.

### \*IDN? (Query Only)

The \*IDN? (Identification) query returns the HFS 9000's unique identification code. This performs the same function as the **View Config** item from the front-panel Calibrate menu.

**Related Commands** \*OPT.

**Syntax** \*IDN?



The query response is an ASCII string separated into four fields by commas:

TEKTRONIX,HFS9000,<serial number>,CF:89.1CN CPU:<firmware version number>



**Examples**    \*IDN?  
                   might return the response  
                   TEKTRONIX,HFS9000,B010101,CF:89.1CN CPU:1.1

---

**NOTE.** Use \*OPT? to determine the particular configuration of your HFS 9000.

---

## \*LRN? (Query Only)

The \*LRN? (Learn Device Setup) query returns a string listing the HFS 9000's settings, except for configuration information for the RS-232-C port or calibration values. You can use this string to return the HFS 9000 to the state it was in when you made the \*LRN? query.

**Related Commands**    HEADER, VERBOSE.

**Syntax**                \*LRN?



Sending the \*LRN? query is the equivalent of sending the FPAN?, TBAS? and VECTOR? queries, and PGEN<x>? for each pulse generator card present.

---

**NOTE.** The \*LRN? query always returns a string with command headers, regardless of the setting of the HEADER command. This is because the returned string is intended to be able to be sent back to the HFS 9000 as a command string. The VERBOSE command can still be used to specify whether the returned headers should be abbreviated or full length.

---

**Examples**    \*LRN?  
                   might return the string:

```
:FPAN:DMEN "Main Menu";DIT "Pulse Menu";DCH "A1";DSET 1;KRES
COAR;:TBAS:MODE AUTO;PVI PER;PER 5.0E-09;COUN 64;TIN:INP 1;SL
OP POS;LEV -1.3E+00;:TBAS:PLIN:INP 0;:TBAS:TOUT:PER 1;PRET 7.
0E-08;:PGENA:CH1:PRAT NORM;LHOL LDEL;THOL WIDT;LVI HIGH;HLIM
0.0E+00;HIGH -8.0E-01;LLIM -2.0E+00;LOW -1.8E+00;LDEL 0.0E+00
;TRAN 2.0E-10;WIDT 2.5E-09;COUT 0;LIM 0;OUTP 0;TINP 0;POL NOR
M;CDEL 0.0E+00;:PGENA:CH2:PRAT NORM;LHOL LDEL;THOL WIDT;
```

```
LVI HIGH;HLIM 0.0E+00;HIGH -8.0E-01;LLIM -2.0E+00;LOW -1.8E+0
0;LDEL 0.0E+00;TRAN 2.0E-10;WIDT 2.5E-09;COUT 0;LIM 0;OUTP 0;
TINP 0;POL NORM;CDEL 0.0E+00;:PGENB:CH1:PRAT NORM;LHOL LDEL;T
HOL WIDT;LVI HIGH;HLIM 0.0E+00;HIGH -8.0E-01;LLIM -2.0E+00;LO
W -1.8E+00;LDEL 0.0E+00;TRAN 2.0E-10;WIDT 2.5E-09;COUT 0;LIM
0;OUTP 0;TINP 0;POL NORM;CDEL 0.0E+00;:PGENB:CH2:PRAT NORM;LH
OL LDEL;THOL WIDT;LVI HIGH;HLIM 0.0E+00;HIGH -8.0E-01;LLIM -2
.0E+00;LOW -1.8E+00;LDEL 0.0E+00;TRAN 2.0E-10;WIDT 2.5E-09;CO
UT 0;LIM 0;OUTP 0;TINP 0;POL NORM;CDEL 0.0E+00;:PGENC:CH1:PRA
T NORM;LHOL LDEL;THOL WIDT;LVI HIGH;HLIM 0.0E+00;HIGH -8.0E-0
1;LLIM -2.0E+00;LOW -1.8E+00;LDEL 0.0E+00;TRAN 2.0E-10;WIDT 2
.5E-09;COUT 0;LIM 0;OUTP 0;TINP 0;POL NORM;CDEL 0.0E+00;:PGEN
C:CH2:PRAT NORM;LHOL LDEL;THOL WIDT;LVI HIGH;HLIM 0.0E+00;HIG
H -8.0E-01;LLIM -2.0E+00;LOW -1.8E+00;LDEL 0.0E+00;TRAN 2.0E-
10;WIDT 2.5E-09;COUT 0;LIM 0;OUTP 0;TINP 0;POL NORM;CDEL 0.0E
+00
```

## \*OPC

The \*OPC (Operation Complete) command generates the operation complete message in the Standard Event Status Register (SESR) when all pending operations finish. The \*OPC? query places the ASCII character “1” into the Output Queue when all pending operations are finished. The \*OPC? response is not available to read until all pending operations finish. For a complete discussion of the use of these registers and the output queue, see page 3–129.

### Related Commands

\*WAI.

### Syntax

\*OPC

\*OPC?

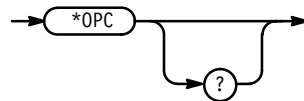

## \*OPT? (Query Only)

The \*OPT? (Optional Identification) query determines which cards are installed in the HFS 9000. Information for all 13 slots is returned in the order of the slots (information for slot 1 first, followed by slot 2, slot 3, etc.).

**Related Commands** \*IDN?.

**Syntax** \*OPT?



\*OPT? returns a string of 13 values of type <NR1> (1 for each slot). Each value will be one of the following:

- 0 if no card is in the slot
- 1 if an unrecognized card is in the slot
- 221 if a CPU card is in the slot
- 4061 if a CPU card is in the slot
- 4075 if an HFS 9DG2 card is in the slot
- 4076 if an HFS 9DG1 card is in the slot
- 4077 if an HFS 9PG2 card is in the slot
- 4078 if an HFS 9PG1 card is in the slot
- 4079 if a Time Base card is in the slot

**Examples** \*OPT?  
might return the string

221,4079,4078,4077,4076,4076,0,0,0,0,0,0,0.

This shows there is a CPU card in slot 1, a Time Base card in slot 2, an HFS 9PG1 card in slot 3, an HFS 9PG2 card in slot 4, and HFS 9DG1 cards in slots 5 and 6. Slots 7 through 13 are empty.

## PGEN<x>?

The PGEN<x> (Pulse Generator) command sets and queries the parameters of a selected pulse channel. PGEN<x>? returns all parameters for the selected card (<x> is A, B, C, D, E, F, G, H, or I).

**Syntax** PGEN<x>?

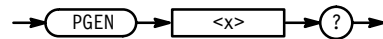

**Examples**

PGENA?

returns all parameters for both A channels. For example, it might return

```
:PGENA:CH1:PRAT NORM;LHOL LDEL;THOL WIDT;LVI HIGH;
HLIM 0.0E+00;HIGH -8.0E-01;LLIM -2.0E+00;LOW -1.8E+00;LDEL 0.
0E+00;TRAN 2.0E-10;WIDT 2.5E-09;COUT 0;LIM 0;OUTP 0;TINP 0;
POL NORM;CDEL 0.0E+00;:PGENA:CH2:PRATNORM;LHOL LDEL;
THOL WIDT;LVI HIGH;HLIM 0.0E+00;HIGH -8.0E-01;LLIM -2.0E+00;
LOW -1.8E+00;LDEL 0.0E+00;TRAN 2.0E-10;WIDT 2.5E-09;COUT 0;LI
M 0;OUTP 0;TINP 0;POL NORM;CDEL 0.0E+00
```

## PGEN<x>:CH<n>?

The PGEN<x> (Pulse Generator) command sets and queries the parameters of a selected pulse channel. PGEN<x>:CH<n>? returns all parameters for the selected channel (<n> is 1 or 2).

**Syntax**

PGEN<x>:CH<n>?

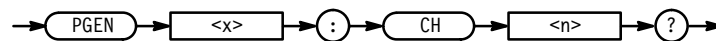

**Examples**

PGENA:CH1?

returns all parameters for channel A1. For example, it might return

```
:PGENA:CH1:PRAT NORM;LHOL LDEL;THOL WIDT;LVI HIGH;
HLIM 0.0E+00;HIGH -8.0E-01;LLIM -2.0E+00;LOW -1.8E+00;
LDEL 0.0E+00;TRAN 2.0E-10;WIDT 2.5E-09;COUT 0;LIM 0;OUTP 0;
TINP 0;POL NORM;CDEL 0.0E+00
```

## PGEN<x>:CH<n>:AMPLitude

PGEN<x>:CH<n>:AMPLitude sets and queries the amplitude of a selected channel. This performs the same function as the **Amplitude** item in the front-panel Pulse menu or Levels menu.

**Related Commands**

PGEN<x>:CH:<n>:HIGH, PGEN<x>:CH<n>:HLIMit,  
 PGEN<x>:CH:<n>:LIMit, PGEN<x>:CH:<n>:LLIMit,  
 PGEN<x>:CH:<n>:LOW, PGEN<x>:CH<n>:LVlew,  
 PGEN<x>:CH:<n>:OFFSet

**Syntax**    PGEN<x>:CH<n>:AMPLitude { MIN | MAX | <NRf> }  
 PGEN<x>:CH<n>:AMPLitude?

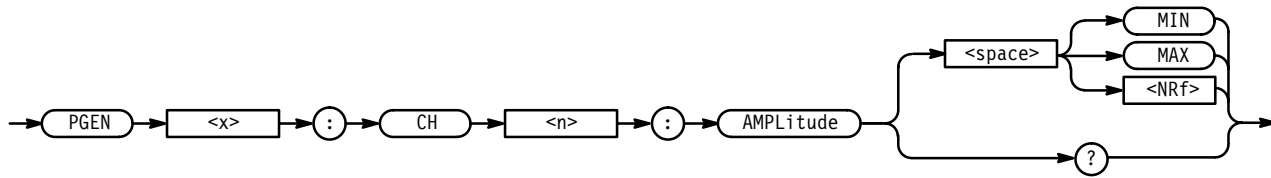

**Arguments**    MIN sets the amplitude to the minimum.

MAX sets the amplitude as follows:

- If LIMit is ON, MAX sets the amplitude to the smallest of:

2 \* (HLIMit – OFFSet),  
 2 \* (OFFSet – LLIMit), or  
 (maximum AMPLitude)

- If LIMit is OFF, MAX sets the amplitude to the smallest of:

2 \* (maximum level – OFFSet),  
 2 \* (OFFSet – minimum level), or  
 (maximum AMPLitude)

<NRf> sets the amplitude to the specified value. Using a value outside the current legal (limited) range sets the amplitude to the nearest legal value and gives an execution warning.

HIGH and LOW are coupled with AMPLitude and OFFSet as follows:

- HIGH = OFFSet + (AMPLitude / 2)
- LOW = OFFSet – (AMPLitude / 2)

**Examples**    PGENA:CH1:AMPL MAX  
                   sets the amplitude of channel A1 to MAX.

PGENB:CH2:AMPL 2.5  
                   sets the amplitude of channel B2 to 2.5 V.

PGENC:CH1:AMPL?  
                   returns the current amplitude of channel C1.

## PGEN<x>:CH<n>:BDATA

PGEN<x>:CH<n>:BDATA (Binary Data Input/Output) provides binary encoded data input/output for a single channel.

**Related Commands**    VECTor:BIOFormat, VECTor:BDATA, SIGNAL:BDATA

**Syntax**    PGEN<x>:CH<n>:BDATA <address>,<count>,<block>

PGEN<x>:CH<n>:BDATA? <address>,<count>

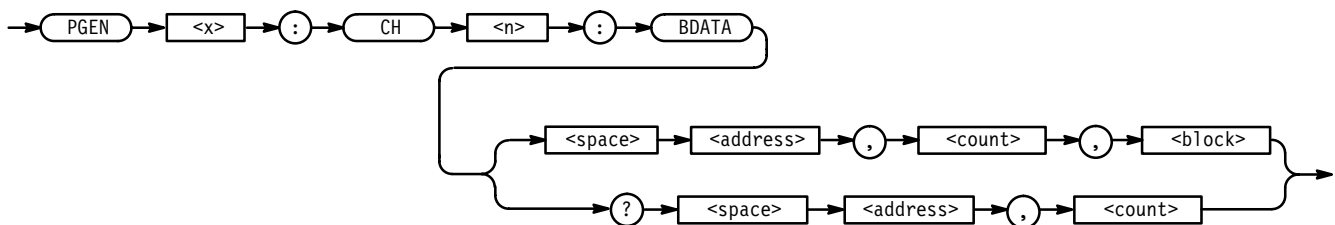

**Arguments**    address specifies the start address for the data.

count specifies the number of data bits that follow or that should be returned.

<block> represents a block of binary bytes.

---

**NOTE.** Each byte in <block> contains eight data bits.

---

**Examples**    PGENC:CH2:BDATA 0,16,#12G8  
                   enters 16 bits of data into channel C2, starting at address 0.

Where:

# is the block start character

1 is the number of digits in the length field

2 is the length field and specifies the number of data bytes (eight bits per byte)

The sixteen bits of data is represented by “G8”, where:

“G” = 01000111

“8” = 00111000

Figure 3–8 illustrates how the data in the above example would be read into the channel memory. Note how each byte is read in from right to left. In other words, the least significant bit of each byte is read in first.

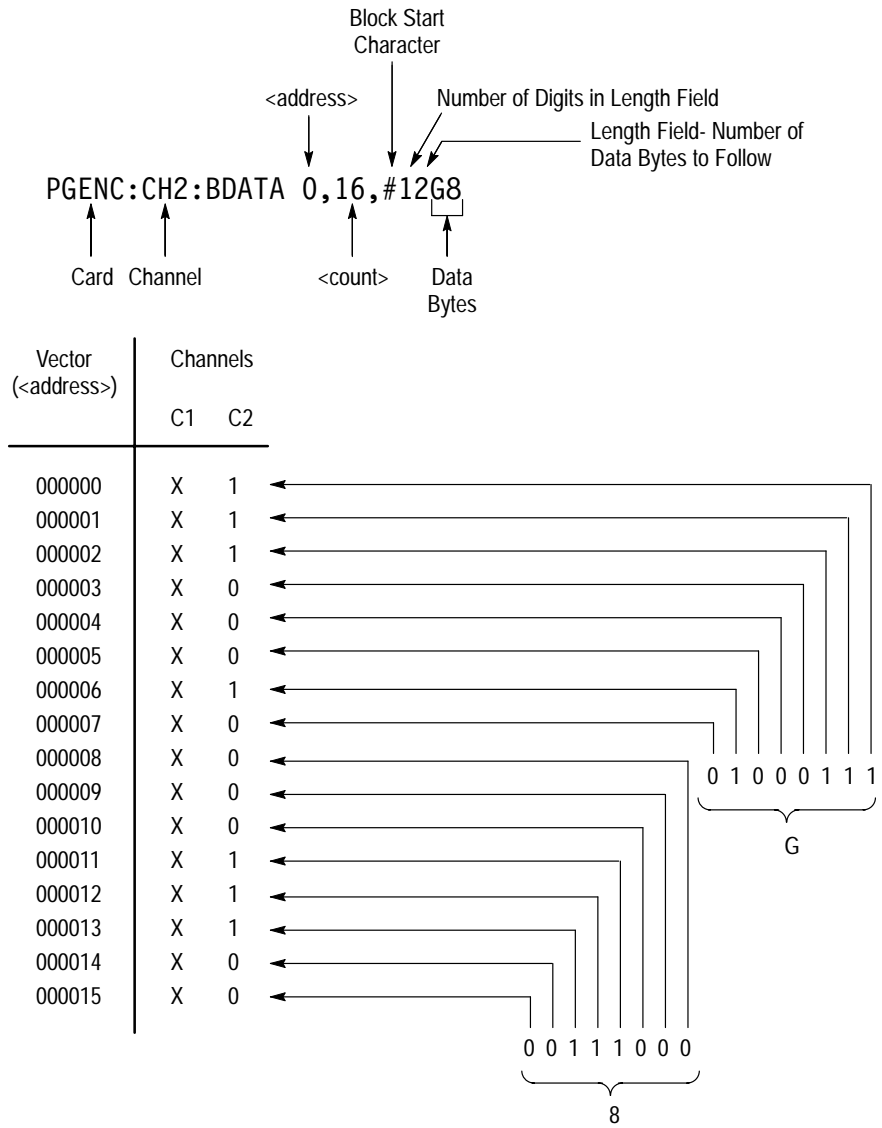

Figure 3-8: Reading Binary Encoded Data into a Channel

PGENA:CH1:BDATA? 0,12

returns the first 12 bits of data (starting from address 0) from channel A1.

## PGEN<x>:CH<n>:BDATA:FILL

PGEN<x>:CH<n>:BDATA:FILL (Binary Data Input/Output) provides a method of filling a channel with binary data.

**Related Commands**    SIGNAL:BDATA, VECTOR:BIOFormat, VECTOR:BDATA

**Syntax**    PGEN<x>:CH<n>:BDATA:FILL <address>,<count>,<binary byte>

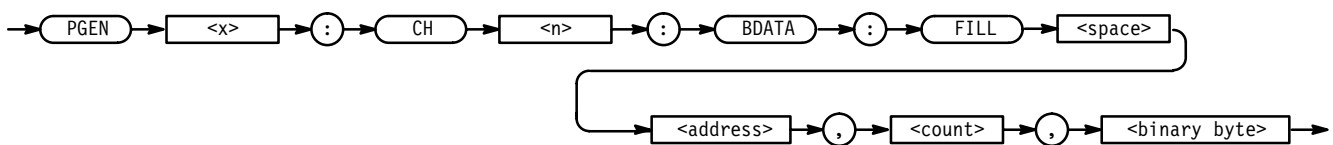

**Arguments**    address sets the start address.

<binary byte> represents the data used to fill the channel.

count specifies the number of number of addresses to be filled. If <count> is less than eight, the rightmost <count> bits are used from the <binary byte>. If <count> is greater than eight, the <binary byte> is repeated the required number of time to satisfy <count>. Note that the byte is read from right to left. That is, the least significant bit is read first.

**Examples**    PGENB:CH2:BDATA:FILL 0,1024, 0  
fills the first 1024 addresses of channel “B2” with all zeros.

PGENA:CH4:BDATA:FILL 0,1024, #HFF  
fills the first 1024 addresses of channel “A4” with all ones.

PGENC:CH1:BDATA:FILL 0,512, #H55  
fills the first 512 addresses of channel “C1” with alternating ones and zeros (that is: 101010101010...).

PGENC:CH1:BDATA:FILL 0,512, #HAA  
fills the first 512 addresses of channel “C1” with alternating zeros and ones (that is: 010101010101...).

## PGEN<x>:CH<n>:CDElay

PGEN<x>:CH<n>:CDElay sets and queries the channel delay of a selected channel. This performs the same functions as the **Chan Delay** item in the front-panel Cal/Deskew menu.



**Syntax** PGEN<x>:CH<n>:CDElay { MIN | MAX | <NRf> }  
 PGEN<x>:CH<n>:CDElay?

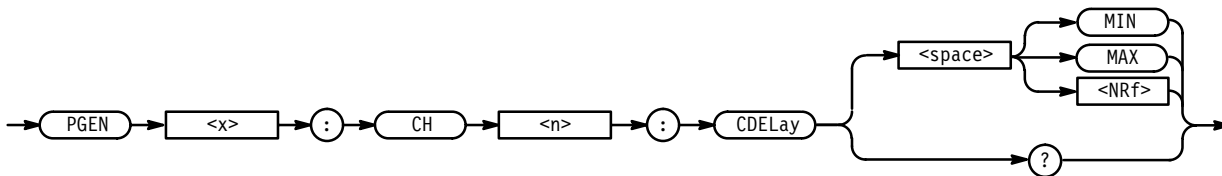

**Arguments** MIN sets the channel delay to the minimum.  
 MAX sets the channel delay to the maximum.  
 <NRf> sets the channel delay to the specified value. Using a value outside the current legal range sets the channel delay to the nearest legal value and gives an execution warning.

**Examples** PGENB:CH2:CDElay 10E-6  
 sets the channel delay of channel B2 to 10  $\mu$ s.  
 PGENA:CH2:CDElay?  
 returns the channel delay value for channel A2.

## PGEN<x>:CH<n>:COUtput

PGEN<x>:CH<n>:COUtput (Complementary Output) enables, disables, or queries a selected complementary **OUTPUT** channel. This performs the same function as the **~Output** item in the front-panel Pulse menu.

**Syntax** PGEN<x>:CH<n>:COUtput { ON | OFF | <NRf> }  
 PGEN<x>:CH<n>:COUtput?

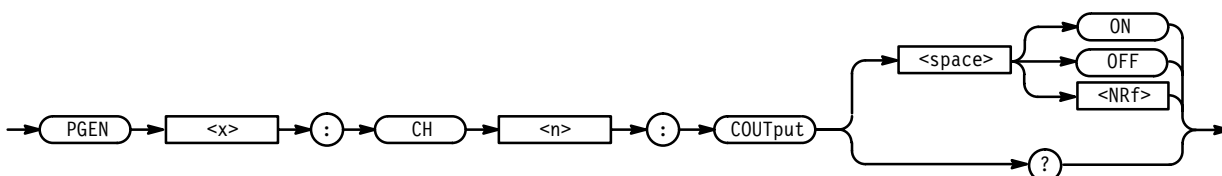

ON or <NRf>  $\neq$  0 enables the complementary output.  
 OFF or <NRf> = 0 disables the complementary output.

- Examples**    `PGENA:CH1:COU ON`  
                   enables the `/OUTPUT` channel of channel A1.
- `PGENB:CH2:COU?`  
                   queries the `/OUTPUT` channel of channel B2.

## PGEN<x>:CH<n>:CVIEW

PGEN<x>:CH<n>:CVIEW (Channel View) controls whether channels are displayed individually (as a channel) or displayed as a signal (a bus). This performs the same function as the **View** item in the Signal, Data Fill, Data Copy, and Vector menus.

- Syntax**    `PGEN<x>:CH<n>:CVIEW { GRoup | CHANnel }`  
                   `PGEN<x>:CH<n>:CVIEW?`

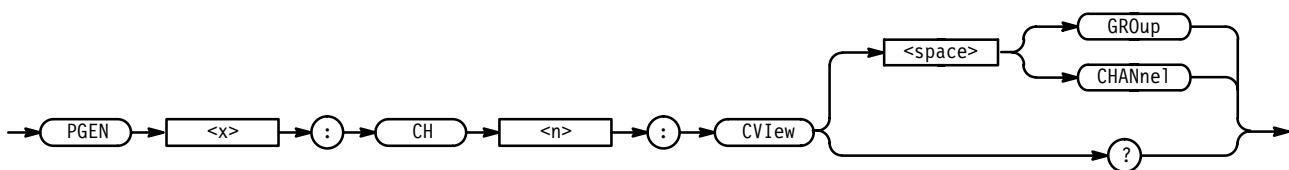

- Arguments**    `GROUP` sets the channel display so that signals are viewed by their name.  
                   `CHANnel` sets the channel display so that signals are viewed individually.

- Examples**    `PGENA:CH1:CVIEW GROUP`  
                   sets the display of channel A1 to group; the group will be displayed by name rather than by card and channel number.
- `PGENA:CH1:CVIEW?`  
                   returns the display setting for channel A1.

## PGEN<x>:CH<n>:DATA

PGEN<x>:CH<n>:DATA (Data Input/Output) provides ascii encoded data input/output for a single channel. Only binary ascii is supported by this command; octal and hexadecimal data input/output (more appropriate for bus-oriented data) is supported by the `:VECTOR` commands.

- Related Commands**    `VECTor:IOFormat`, `VECTor:DATA`

**Syntax** PGEN<x>:CH<n>:DATA <address>,<count>,<ascii data>  
PGEN<x>:CH<n>:DATA? <address>,<count>

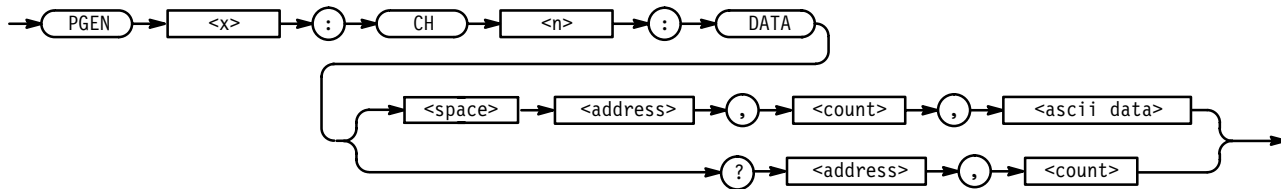

**Arguments** address sets/queries the start address for the data.  
count specifies the number of data elements that follow or that should be returned.  
<ascii data> represents the ascii-formatted binary data to be entered.

**Examples** PGENC:CH2:DATA 0,16,"1110001000011100"  
enters 16 bits of data into channel C2, starting at address 0.  
PGENA:CH1:DATA? 0,12  
returns the first 12 bits of data (starting from address 0) from channel A1.

### PGEN<x>:CH<n>:DATA:COPY

PGEN<x>:CH<n>:DATA:COPY (Data Copy) copies data from one channel to another.

**Related Commands** SIGNAL:DATA:COPY

**Syntax** PGEN<x>:CH<n>:DATA:COPY <address1>,<count>,<channel1>,<address2>

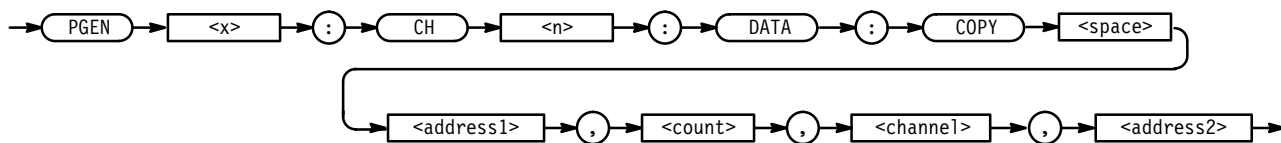

**Arguments** <x> and <n> specify the destination channel.  
<address1> specifies the destination address.  
count specifies the number of data elements to be copied.

<channel> specifies the source channel.

<address2> represents the source address.

**Examples** PGENA:CH1:DATA:COPY 0,512,"C1", 1024  
copies 512 data bits from channel "C1", address 1024, to channel A1, address 0.

## PGEN<x>:CH<n>:DATA:SWAP

PGEN<x>:CH<n>:DATA:SWAP (Data Swap) swaps blocks of data between channels.

**Syntax** PGEN<x>:CH<n>:DATA <address1>,<count>,<channel>,<address2>

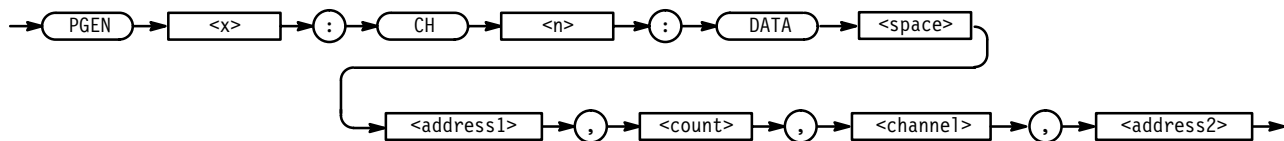

**Arguments** <x> and <n> specify the card and channel to which data is swapped; in other words, these arguments identify the destination channel.

address1 sets the destination address.

count specifies the number of data elements to be swapped.

<channel> specifies the channel from which data is to be swapped; it identifies the source channel.

<address2> identifies the beginning of the block of data to be swapped.

**Examples** PGENB:CH2:DATA:SWAP 512,10,"B3", 0  
swaps 10 bits of data from channel "B3", address 0, with channel "B2", address 512.

## PGEN<x>:CH<n>:DCYCLE

PGEN<x>:CH<n>:DCYCLE (Duty Cycle) sets and queries the duty cycle of a selected channel. This performs the same function as the **Duty Cycle** item in the front-panel Pulse menu.

**Related Commands** PGEN<x>:CH<n>:LDElay, PGEN<x>:CH<n>:TDElay,  
PGEN<x>:CH<n>:THOLd, PGEN<x>:CH<n>:WIDTh, TBAS:PERiod

**Syntax** PGEN<x>:CH<n>:DCYClE { MIN | MAX | <NRf> }  
PGEN<x>:CH<n>:DCYClE?

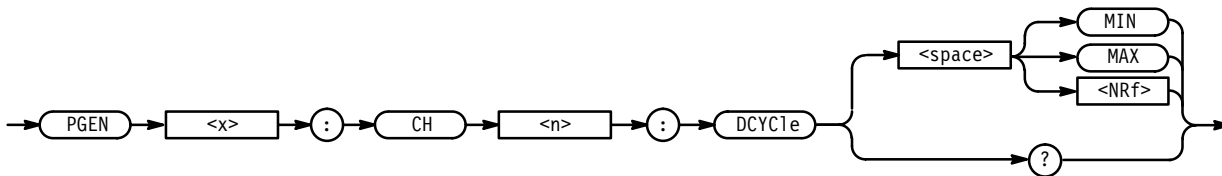

**Arguments** MIN sets the duty cycle to ((minimum WIDTh) \* 100 / TBAS:PERiod).  
MAX sets the duty cycle to ((channel period – minimum recovery width) \* 100 / channel period), where channel period is TBAS:PERiod if PGEN<x>:CH<n>:PRATe is either NORMAl or OFF, and channel period is 2 if PGEN<x>:CH<n>:PRATe is HALF. Minimum recovery width is 800 ps for both High Speed and Var Rate cards.  
<NRf> sets the duty cycle to the specified value. Using a value outside the current legal range sets the duty cycle to the nearest legal value and gives an execution warning.

TDElay and WIDTh are coupled with DCYClE as follows:

- TDElay = ((DCYClE \* TBAS:PERiod) / 100) + LDElay
- WIDTh = ((DCYClE \* TBAS:PERiod) / 100)

**Examples** PGENA:CH2:DCYC 50  
sets the duty cycle of channel A2 to 50%.  
PGENB:CH1:DCYC?  
returns the duty cycle of channel B1.

## PGEN<x>:CH<n>:DRADix

PGEN<x>:CH<n>:DRADix (Data Radix) controls how data is displayed on the front panel. This command performs the same function as the **Data Radix** item in the front-panel Data Fill menu.

**Syntax** PGEN<x>:CH<n>:DRADix { OCT | DEC | HEX }

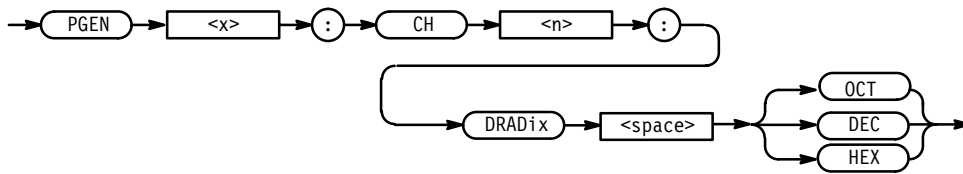

**Arguments** <signal> identifies the signal whose data radix is to be set or queried.  
 <OCT> specifies an octal data radix.  
 <DEC> specifies a decimal data radix.  
 <HEX> specifies a hexadecimal data radix.

**Examples** PGENA:CH1:DRADIX HEX  
 sets the data radix for Channel A1 to hexadecimal.  
 PGENA: CH1: DRADIX?  
 returns the data radix for Channel A2.

## PGEN<x>:CH<n>:HIGH

PGEN<x>:CH<n>:HIGH sets and queries the high level of the selected channel. This performs the same function as the **High Level** item in the front-panel Pulse menu and Levels menu.

**Related Commands** PGEN<x>:CH<n>:AMPLitude, PGEN<x>:CH<n>:HLIMit, PGEN<x>:CH:<n>:LIMit, PGEN<x>:CH:<n>:LLIMit, PGEN<x>:CH:<n>:LOW, PGEN<x>:CH<n>:LVIEW, PGEN<x>:CH:<n>:OFFSet

**Syntax** PGEN<x>:CH<n>:HIGH { MIN | MAX | <NRf> }  
 PGEN<x>:CH<n>:HIGH?

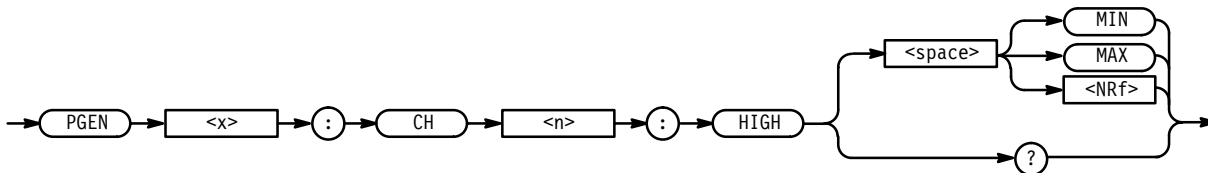

**Arguments** MIN sets the high level to (LOW + minimum AMPLitude).

MAX sets the high level to HLIMit if LIMit is ON, and to the maximum level if LIMit is OFF.

<NRf> sets the high level to the specified value. Using a value outside the current legal range sets the logical high level to the nearest legal value and gives an execution warning.

AMPLitude and OFFSet are coupled with HIGH and LOW as follows:

- $AMPLitude = (HIGH - LOW)$
- $OFFSet = (HIGH - LOW) / 2$

**Examples**

PGENA:CH2:HIGH MAX  
sets the high level of channel A2 to MAX.

PGENB:CH1:HIGH 3.2  
sets the high level of channel B1 to 3.2 V.

PGENC:CH1:HIGH?  
returns the high level of channel C1.

**PGEN<x>:CH<n>:HLIMit**

PGEN<x>:CH<n>:HLIMit (High Limit) sets and queries the high limit of the selected channel. This performs the same function as the **High Limit** item in the front-panel Levels menu.

**Related Commands**

PGEN<x>:CH<n>:AMPLitude, PGEN<x>:CH:<n>:HIGH, PGEN<x>:CH:<n>:LIMit, PGEN<x>:CH:<n>:LLIMit, PGEN<x>:CH:<n>:LOW, PGEN<x>:CH:<n>:OFFSet

**Syntax**

PGEN<x>:CH<n>:HLIMit { MIN | MAX | <NRf> }  
PGEN<x>:CH<n>:HLIMit?

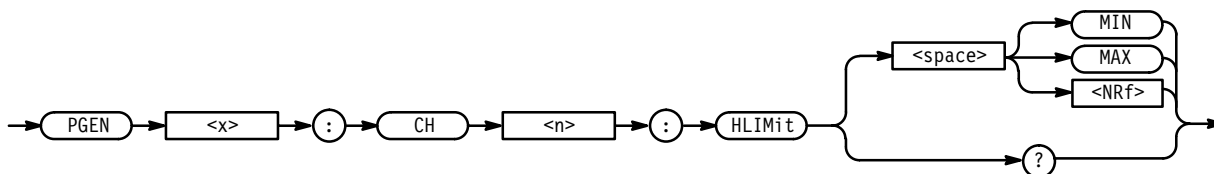

**Arguments**

MIN sets the high limit to (LLIMit + minimum AMPLitude).

MAX sets the high limit to the maximum.

<NRf> sets the high limit to the specified value. Using a value outside the current legal range sets the high limit to the nearest legal value and gives an execution warning.

- Examples**
- PGENB:CH2:HLIM 3.5V  
sets the high limit of channel B2 to 3.5 V.
  - PGENA:CH2:HLIM MAX  
sets the high limit of channel A2 to the maximum level.
  - PGENA:CH1:HLIM?  
returns the high limit of channel A1.

## PGEN<x>:CH<n>:LDElay

PGEN<x>:CH<n>:LDElay (Leading Delay) sets and queries the leading delay of the selected channel. This performs the same function as the **Lead Delay** item in the Pulse menu.

- Related Commands**
- PGEN<x>:CH<n>:DCYCLe, PGEN<x>:CH<n>:LHOLd,
  - PGEN<x>:CH<n>:TDElay, PGEN<x>:CH<n>:WIDTh, TBAS:PERiod

- Syntax**
- PGEN<x>:CH<n>:LDElay { MIN | MAX | <NRf> }
  - PGEN<x>:CH<n>:LDElay?

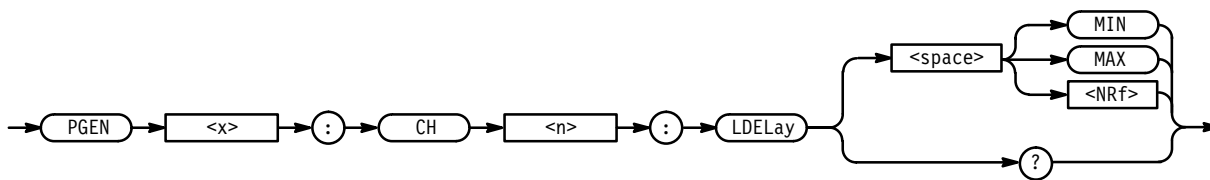

- Arguments**
- MIN sets the leading delay to the minimum.
  - MAX depends on the values of PGEN<x>:CH<n>:THOLd and PGEN<x>:CH<n>:TDElay. If THOLd equals TDElay, then MAX sets LDElay as follows:
    - LDElay = TDElay.
  - If THOLd does not equal TDElay, then MAX sets LDElay as follows:
    - LDElay = channel period



where channel period is TBAS:PERiod if PGEN<x>:CH<n>:PRATe is either NORMAL or OFF, and channel period is 2 if PGEN<x>:CH<n>:PRATe is HALF.

<Nrf> sets the leading delay to the specified value. Using a value outside the current legal range sets the leading delay to the nearest legal value and gives an execution warning.

PHASe is coupled with LDELay as follows:

- $PHASe = (LDELay * 100) / TBAS:PERiod$

**Examples** PGENA:CH1:LDEL 1ns  
sets the leading delay of channel A1 to 1 ns.

PGENA:CH2:LDEL?  
returns the leading delay of channel A2.

## PGEN<x>:CH<n>:LHOLd

PGEN<x>:CH<n>:LHOLd (Leading Hold) sets the leading edge hold of the selected channel and sets the display view, or queries the leading edge hold of the selected channel. This performs the same function as **Select** from the **Lead Delay** or **Phase** items in the front-panel Pulse menu.

**Related Commands** PGEN<x>:CH<n>:LDELay, PGEN<x>:CH<n>:PHASe

**Syntax** PGEN<x>:CH<n>:LHOLd { LDELay | PHASe }  
PGEN<x>:CH<n>:LHOLd?

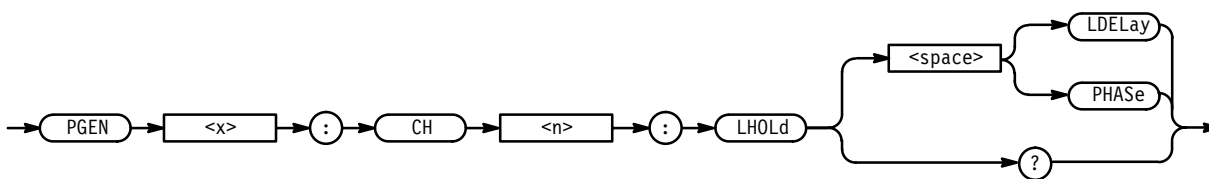

**Arguments** LDELay sets the leading edge hold and the front panel display view to LDELay. In this mode, LDELay remains constant while TBAS:PERiod varies.

PHASe sets the leading edge hold and the front panel display view to PHASe. In this mode, PHASe remains constant while TBAS:PERiod varies.

**Examples** PGENA:CH1:LHOL LDEL  
sets the leading edge hold of channel A1 to LDELay.

PGENB:CH2:LHOL?  
 returns the leading edge hold of channel B2.

## PGEN<x>:CH<n>:LIMit

PGEN<x>:CH<n>:LIMit (Limit State) sets and queries limiting. This performs the same function as the **Limit** item in the front-panel Levels menu.

**Related Commands** PGEN<x>:CH<n>:AMPLitude, PGEN<x>:CH:<n>:HIGH, PGEN<x>:CH<n>:HLIMit, PGEN<x>:CH:<n>:LLIMit, PGEN<x>:CH:<n>:LOW, PGEN<x>:CH:<n>:OFFSet

**Syntax** PGEN<x>:CH<n>:LIMit { ON | OFF | <NRf> }  
 PGEN<x>:CH<n>:LIMit?

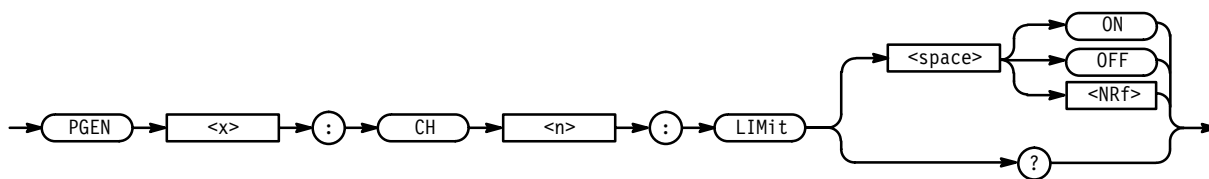

**Arguments** ON or <NRf> ≠ 0 turns limiting ON.  
 OFF or <NRf> = 0 turns limiting OFF.

**Examples** PGENA:CH1:LIM ON  
 turns limiting on for channel A1.  
 PGENC:CH1:LIM?  
 returns the current setting of the limit function for channel C1.

## PGEN<x>:CH<n>:LLIMit

PGEN<x>:CH<n>:LLIMit (Low Limit) sets and queries the low limit of the selected channel. This performs the same function as the **Low Limit** item in the front-panel Levels menu.

**Related Commands** PGEN<x>:CH<n>:AMPLitude, PGEN<x>:CH:<n>:HIGH, PGEN<x>:CH<n>:HLIMit, PGEN<x>:CH:<n>:LIMit, PGEN<x>:CH:<n>:LOW, PGEN<x>:CH:<n>:OFFSet

**Syntax** PGEN<x>:CH<n>:LLIMit { MIN | MAX | <NRf> }  
PGEN<x>:CH<n>:LLIMit?

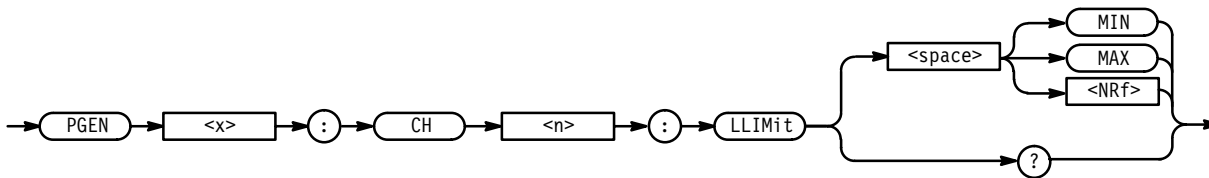

**Arguments** MIN sets the low limit to the minimum.  
MAX sets the low limit to (HLIMit – minimum AMPLitude).  
<NRf> sets the low limit to the specified value. Using a value outside the current legal range sets the low limit to the nearest legal value and gives an execution warning.

**Examples** PGENB:CH2:LLIM MIN  
sets the low limit of channel B2 to the minimum level.  
PGENA:CH1:LLIM?  
returns the low limit of channel A1.

## PGEN<x>:CH<n>:LOW

PGEN<x>:CH<n>:LOW sets and queries the low level of the selected channel. This performs the same function as the **Low Level** item in the front-panel Pulse menu and Levels menu.

**Related Commands** PGEN<x>:CH<n>:AMPLitude, PGEN<x>:CH:<n>:HIGH,  
PGEN<x>:CH<n>:HLIMit, PGEN<x>:CH:<n>:LIMit,  
PGEN<x>:CH:<n>:LLIMit, PGEN<x>:CH<n>:LVIEW,  
PGEN<x>:CH:<n>:OFFSet

**Syntax** PGEN<x>:CH<n>:LOW { MIN | MAX | <NRf> }  
PGEN<x>:CH<n>:LOW?

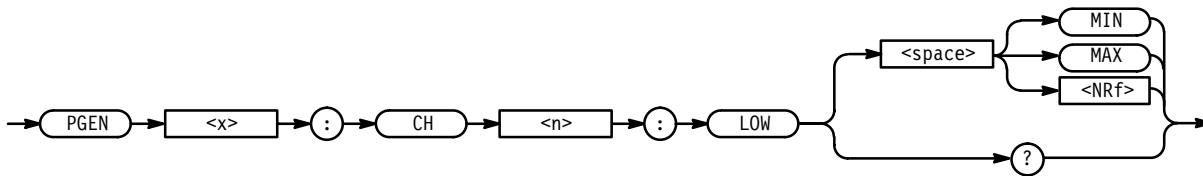

**Arguments** MIN sets the low level as follows:

- If LIMit is ON, the low level is set to LLIMit.
- If LIMit is OFF, the low level is set to the minimum level.

MAX sets the low level to (HIGH – minimum AMPLitude).

<NRf> sets the low level to the specified value. Using a value outside the current legal range sets the low level to the nearest legal value and gives an execution warning.

AMPLitude and OFFSet are coupled with HIGH and LOW as follows:

- $AMPLitude = (HIGH - LOW)$
- $OFFSet = (HIGH - LOW) / 2$

**Examples** PGENB:CH1:LOW -3.2  
sets the low level of channel B1 to -3.2 V.

PGENA:CH1:LOW?  
returns the low level for channel A1.

## PGEN<x>:CH<n>:LView

PGEN<x>:CH<n>:LView (Level View) sets and queries the level display view. This performs the same functions as **Select** from the **High Level, Low Level, Amplitude, or Offset** items from the front-panel Pulse menu and Levels menu.

**Related Commands** PGEN<x>:CH<n>:AMPLitude, PGEN<x>:CH<n>:HIGH, PGEN<x>:CH<n>:LOW, PGEN<x>:CH<n>:OFFSet

**Syntax** PGEN<x>:CH<n>:LView { AMPLitude | OFFSet | LOW | HIGH }  
PGEN<x>:CH<n>:LView?

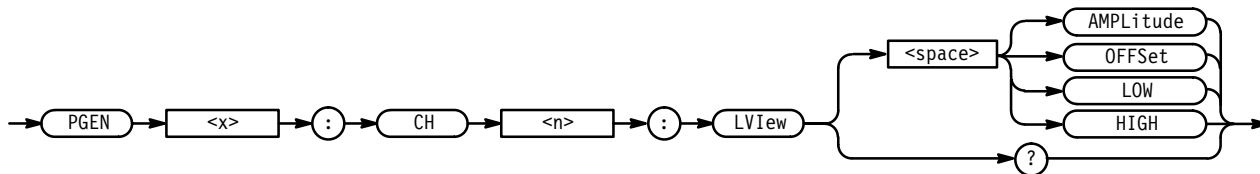

**Arguments** AMPLitude or OFFSet sets the level display view to AMPLitude/OFFSet.  
HIGH or LOW sets the level display view to HIGH/LOW.

**Examples** PGENA:CH1:LVI AMPL  
sets the view for channel A1 to AMPLitude/OFFSet.  
PGENB:CH2:LVI?  
returns the level display view for channel B2.

### PGEN<x>:CH<n>:OFFSet

PGEN<x>:CH<n>:OFFSet sets and queries the offset of the selected channel. This performs the same function as the **Offset** item in the front-panel Pulse menu and Levels menu.

**Related Commands** PGEN<x>:CH<n>:AMPLitude, PGEN<x>:CH:<n>:HIGH, PGEN<x>:CH<n>:HLIMit, PGEN<x>:CH:<n>:LIMit, PGEN<x>:CH:<n>:LLIMit, PGEN<x>:CH:<n>:LOW, PGEN<x>:CH<n>:LVIEW

**Syntax** PGEN<x>:CH<n>:OFFSet { MIN | MAX | <NRf> }  
PGEN<x>:CH<n>:OFFSet?

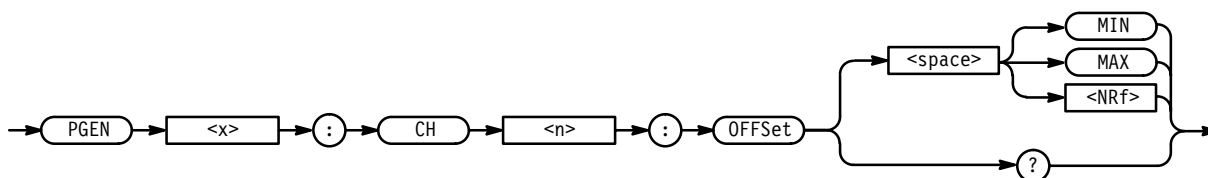

**Arguments** MIN sets the offset as follows:

- If LIMit is ON, the offset is (LLIMit + (AMPLitude / 2))
- If LIMit is OFF, the offset is (minimum level + (AMPLitude / 2))

MAX sets the offset as follows:

- If LIMit is ON, the offset is  $(HLIMit - (AMPLitude / 2))$
- If LIMit is OFF, the offset is  $(maximum\ level - (AMPLitude / 2))$

<NRf> sets the offset to the specified value. Using a value outside the current legal range sets the offset to the nearest legal value and gives an execution warning.

HIGH and LOW are coupled with AMPLitude and OFFSet as follows:

- $HIGH = OFFSet + (AMPLitude / 2)$
- $LOW = OFFSet - (AMPLitude / 2)$

**Examples**    PGENB:CH1:OFFS 2.5  
                   sets the offset for channel B1 to 2.5 V.

                  PGENA:CH2:OFFS?  
                   returns the offset for channel A2.

## PGEN<x>:CH<n>:OUTPut

PGEN<x>:CH<n>:OUTPut enables, disables, or queries the output setting of the selected channel. This performs the same function as the **Output** item in the front-panel Pulse menu.

**Syntax**    PGEN<x>:CH<n>:OUTPut { ON | OFF | <NRf> }  
                   PGEN<x>:CH<n>:OUTPut?

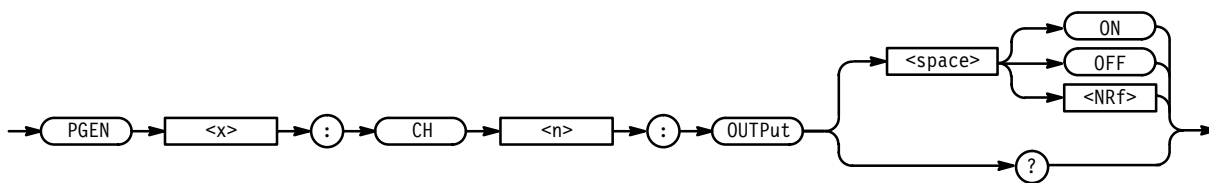

**Arguments**    ON or <NRf>  $\neq 0$  enables the output.  
                   OFF or <NRf> = 0 disables the output.

**Examples**    PGENA:CH1:OUTP ON  
                   enables the output for channel A1.

PGENB:CH2:OUTP OFF  
 disables the output for channel B2.

PGENB:CH2:OUTP?  
 returns the output setting for channel B2.

## PGEN<x>:CH<n>:PHASe

PGEN<x>:CH<n>:PHASe sets and queries the phase of the selected channel. This performs the same function as the **Phase** item in the front-panel Pulse menu.

**Related Commands** PGEN<x>:CH<n>:LDELay, PGEN<x>:CH<n>:LHOLD

**Syntax** PGEN<x>:CH<n>:PHASe { MIN | MAX | <NRf> }

PGEN<x>:CH<n>:PHASe?

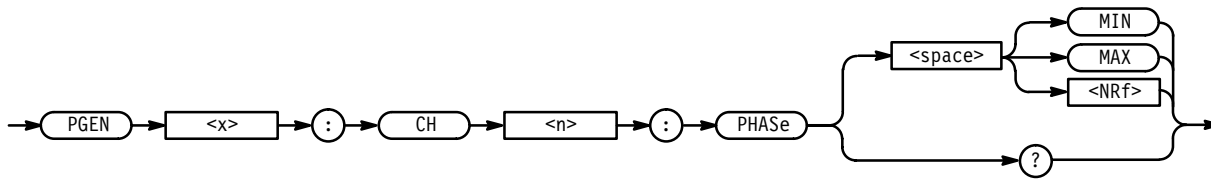

**Arguments** MIN sets the phase to  $((\text{minimum LDELay} * 100) / \text{channel period})$ , where channel period is TBAS:PERiod if PGEN<x>:CH<n>:PRATe is either NORMal or OFF, and channel period is 2 if PGEN<x>:CH<n>:PRATe is HALF.

MAX depends on the values of PGEN<x>:CH<n>:THOLd and PGEN<x>:CH<n>:TDELay. If THOLd does not equal TDELay, then MAX sets PHASe as follows:

- PHASe = 100.

If THOLd equals TDELay, then MAX sets PHASe as follows:

- $\text{PHASe} = (\text{TDELay} * 100) / \text{channel period}$ .

where channel period is TBAS:PERiod if PGEN<x>:CH<n>:PRATe is either NORMal or OFF, and channel period is 2 if PGEN<x>:CH<n>:PRATe is HALF.

<NRf> sets the phase to the specified value. Using a value outside the current legal range sets the phase to the nearest legal value and gives an execution warning.

**Examples**    PGENA:CH1:PHAS 10PCT  
                   sets the phase of channel A1 to 10%.

                  PGENC:CH2:PHAS?  
                   returns the phase of channel C2.

## PGEN<x>:CH<n>:POLarity

PGEN<x>:CH<n>:POLarity sets and queries the polarity of the selected channel. This performs the same function as the **Polarity** item in the front-panel Pulse menu.

**Syntax**    PGEN<x>:CH<n>:POLarity { NORMa1 | COMPLement }  
                   PGEN<x>:CH<n>:POLarity?

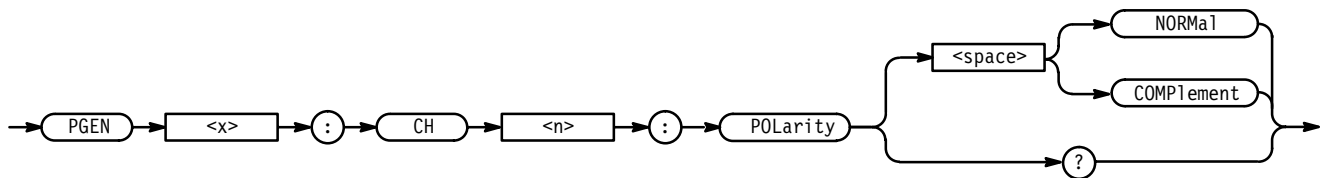

**Arguments**    NORM sets the polarity to normal.  
                   COMP sets the polarity to complement.

**Examples**    PGENA:CH1:POL NORM  
                   sets the polarity of channel A1 to normal.

                  PGENB:CH2:POL?  
                   returns the polarity of channel B2.

## PGEN<x>:CH<n>:PRATe

PGEN<x>:CH<n>:PRATe (Pulse Rate) sets and queries the pulse rate mode of the selected channel. This performs the same functions as the **Pulse Rate** item in the front-panel Pulse menu.

**Syntax**    PGEN<x>:CH<n>:PRATe { HALF | NORMa1 | QUARter | EIGHth | OFF }  
                   PGEN<x>:CH<n>:PRATe?



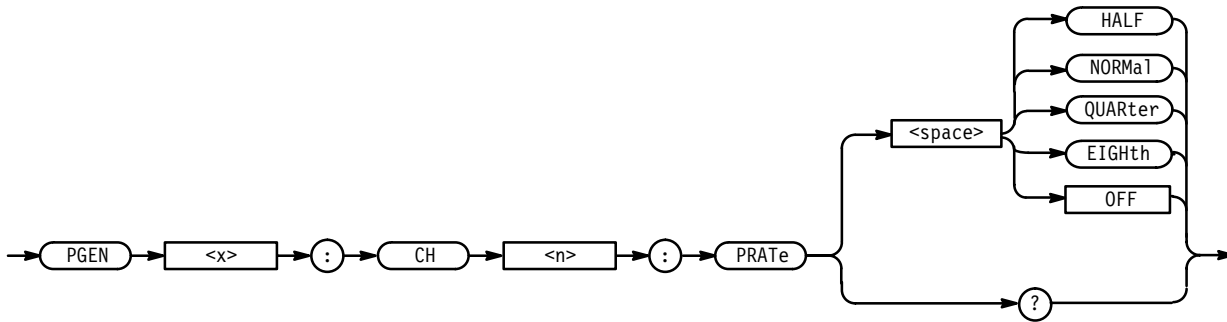

- Arguments**
- HALF sets the pulse rate to half rate.
  - NORMa1 sets the pulse rate to normal.
  - QUARter sets the pulse rate to one quarter of normal.
  - EIGHth sets the pulse rate to one eighth of normal.
  - OFF turns the pulse rate off. When the pulse rate is off, the output voltage level is defined by PGEN<x>:CH<n>:LOW unless PGEN<x>:CH<n>:POLarity is set to COMP, in which case the output voltage is defined by PGEN<x>:CH<n>:HIGH.

- Examples**
- PGENC:CH1:PRAT HALF  
sets channel C1's half mode on.
  - PGENA:CH2:PRAT?  
returns the frequency scale mode for channel A2.

### PGEN<x>:CH<n>:SIGNal

PGEN<x>:CH<n>:SIGNal (Signal Name) assigns a name to a channel. The signal name is used for both display purposes and to link :SIGNal commands to a channel. This performs the same function as the **Signal Name** item in the Signal menu.

- Related Commands**
- SIGNal:<parameter>, SIGNal:TYPE, SIGNal:CVIEW, SIGNal:BDATA, SIGNal:BDATA:FILL, SIGNal:DATA, SIGNal:DATA:COPY, SIGNal:DATA:SWAP, SIGNal:DRADix

- Syntax**
- PGEN<x>:CH<n>:SIGNal <pin>
  - PGEN<x>:CH<n>:SIGNal?

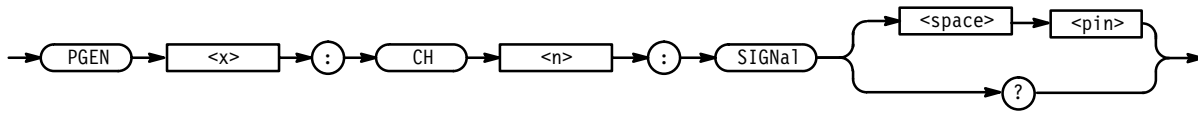

**Arguments** pin is the name to be assigned to the channel.

**Examples** PGENA:CH1:SIGNAL "~G2"  
 assigns the name "~G2" to channel A1.

PGENA:CH2:SIGNAL "Addr[6]"  
 assigns the name "Addr6" to channel A2.

PGENF:CH1:SIGNAL?  
 returns the name assigned to channel F1.

## PGEN<x>:CH<n>:TDELAy

PGEN<x>:CH<n>:TDELAy (Trailing Delay) sets and queries the trailing delay of the selected channel. This performs the same function as the **Trail Delay** item in the front-panel Pulse menu.

**Related Commands** PGEN<x>:CH<n>:DCYCLe, PGEN<x>:CH<n>:LDELAy,  
 PGEN<x>:CH<n>:THOLd, PGEN<x>:CH<n>:WIDTh, TBAS:PERiod

**Syntax** PGEN<x>:CH<n>:TDELAy { MIN | MAX | <NRf> }  
 PGEN<x>:CH<n>:TDELAy?

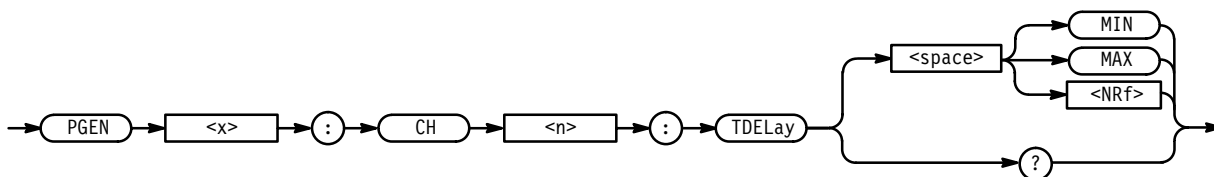

**Arguments** MIN sets the trailing delay to (LDELAy + minimum WIDTh).

MAX sets the trailing delay to (LDELAy + channel period – minimum WIDTh), where channel period is TBAS:PERiod if PGEN<x>:CH<n>:PRATe is either NORMAl or OFF, and channel period is 2 if PGEN<x>:CH<n>:PRATe is HALF.

<NRf> sets the trailing delay to the specified value. Using a value outside the current legal range sets the trailing delay to the nearest legal value and gives an execution warning.

DCYClE and WIDTh are coupled with TDELay as follows:

- $DCYClE = (TDELay - LDELay) * 100 / TBAS:PERiod$
- $WIDTh = (TDELay - LDELay)$

**Examples** PGENA:CH2:TDEL 3.5E-9  
 sets the trailing delay of channel A2 to 3.5 ns.

PGENB:CH1:TDEL?  
 returns the trailing delay setting for channel B1.

## PGEN<x>:CH<n>:THOLd

PGEN<x>:CH<n>:THOLd (Trailing Hold) sets and queries the selected channel's trailing edge hold, and sets the front-panel display view. This performs the same function as **Select** from the **Trail Delay**, **Duty Cycle**, or **Width** items in the front-panel Pulse menu.

**Related Commands** PGEN<x>:CH<n>:DCYClE, PGEN<x>:CH<n>:TDELay, PGEN<x>:CH<n>:WIDTh, TBAS:PERiod

**Syntax** PGEN<x>:CH<n>:THOLd { TDELay | DCYClE | WIDTh }  
 PGEN<x>:CH<n>:THOLd?

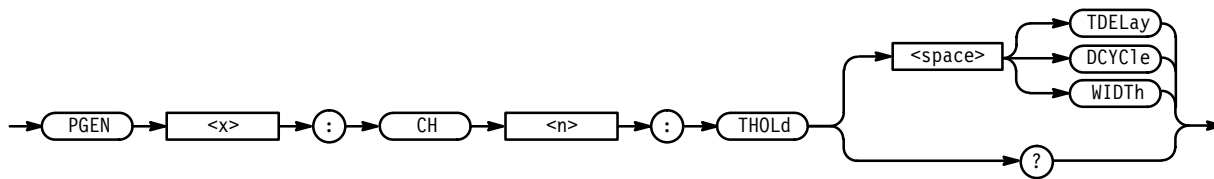

**Arguments** TDELay sets the trailing edge hold and the front-panel display view to TDELay. In this mode, TDELay remains constant while TBAS:PERiod, PGEN<x>:CH<n>:LDELay, and PGEN<x>:CH<n>:PHASe are varied.

DCYClE sets the trailing edge hold and the front-panel display view to DCYClE. In this mode, DCYClE remains constant while TBAS:PERiod, PGEN<x>:CH<n>:LDELay, and PGEN<x>:CH<n>:PHASe are varied.

WIDTh sets the trailing edge hold and the front-panel display view to WIDTh. In this mode, WIDTh remains constant while TBAS:PERiod, PGEN<x>:CH<n>:LDELay, and PGEN<x>:CH<n>:PHASe are varied.

- Examples**    PGENA:CH1:THOL DCYC  
                   sets the trailing edge hold for channel A1 to DCYCle.
- PGENB:CH2:THOL?  
                   returns the trailing edge hold setting for channel B2.

## PGEN<x>:CH<n>:TINPut

PGEN<x>:CH<n>:TINPut (Transducer Input) enables, disables, or queries the selected **Transducer In** connector. This performs the same function as the **Transducer** item in the front-panel Pulse menu.

- Syntax**    PGEN<x>:CH<n>:TINPut { ON | OFF | <NRf> }  
                   PGEN<x>:CH<n>:TINPut?

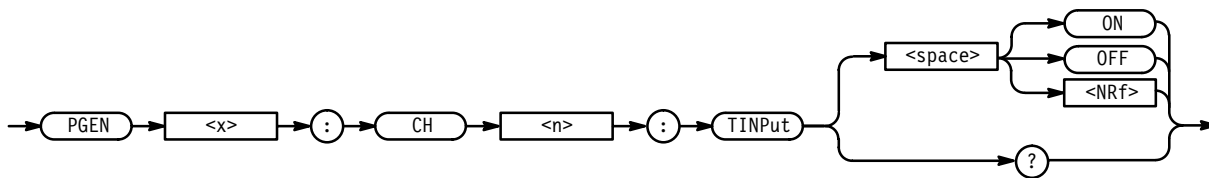

- Arguments**    ON or <NRf> ≠ 0 enables the **Transducer In** channel.  
                   OFF or <NRf> = 0 disables the **Transducer In** channel.

- Examples**    PGENA:CH1:TINP ON  
                   enables the **Transducer In** connector for channel A1.
- PGENB:CH2:TINP?  
                   returns the state of the **Transducer In** connector for channel B2.

## PGEN<x>:CH<n>:TRANSition (HFS 9PG2 and HFS 9DG2 Only)

PGEN<x>:CH<n>:TRANSition sets and queries the transition of the selected channel. This performs the same function as the **Transition** item in the front-panel Pulse menu.

- Syntax**    PGEN<x>:CH<n>:TRANSition { MIN | MAX | <NRf> }  
                   PGEN<x>:CH<n>:TRANSition?

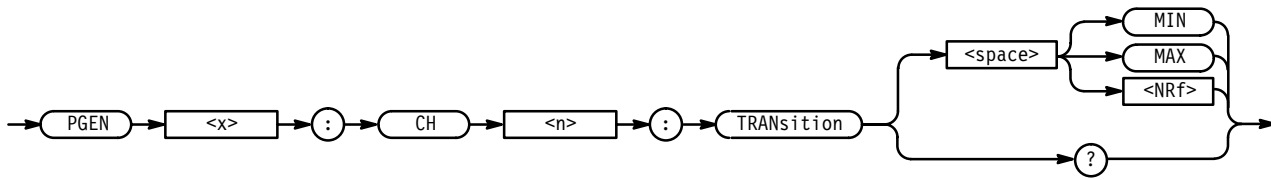

**Arguments**

MIN sets the transition to the minimum.

MAX sets the transition to the maximum.

<NRf> sets the transition to the specified value. Using a value outside the current legal range sets the transition to the nearest legal value and gives an execution warning.

---

**NOTE.** Because High Speed pulse generator cards have a fixed transition rate, you cannot use the PGEN<x>:CH<n>:TRAN command with them.

---

**Examples**

PGENB:CH1:TRAN 1ns  
sets the transition of channel B1 to 1 ns.

PGENA:CH1:TRAN MAX  
sets the transition of channel A1 to the maximum transition.

PGENC:CH2:TRAN?  
returns the transition setting of channel C2.

**PGEN<x>:CH<n>:TYPE**

PGEN<x>:CH<n>:TYPE (Signal Type) specifies the type of output for the specified channel. This performs the same function as the **Signal Type** item in the Signal and Pulse menus.

**Syntax**

PGEN<x>:CH<n>:TYPE { NRZ | RZ | R1 | PULSe | DC | TRANSDucer }

PGEN<x>:CH<n>:TYPE?

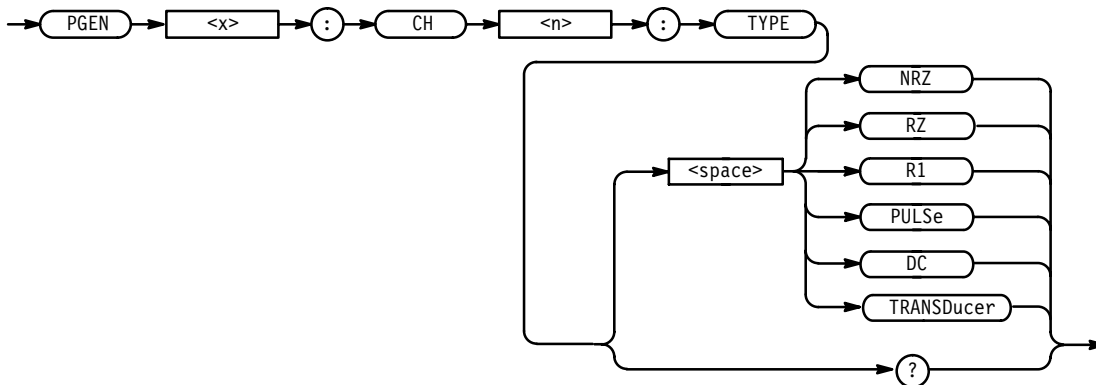

- Arguments**
- NRZ sets the signal type to “Non-Return to Zero”.
  - RZ sets the signal type to “Return to Zero”.
  - R1 sets the signal type to “Return to One”.
  - PULSe sets the signal type to “Pulse”.
  - DC sets the signal type to DC.
  - TRANSDucer sets the signal type to transducer.

- Examples**
- PGENA:CH1:TYPE NRZ  
sets the signal type of channel A1 to non-return to zero.
  - PGENF:CH1:TYPE PULSE  
sets the signal type of channel F1 to pulse.
  - PGENC:CH4:SIGNAL?  
returns the signal type of channel C4.

## PGEN<x>:CH<n>:WIDTH

PGEN<x>:CH<n>:WIDTH sets and queries the width of the specified channel. This performs the same function as the **Width** item in the front-panel Pulse menu.

**Related Commands** PGEN<x>:CH<n>:DCYCLE, PGEN<x>:CH<n>:LDELAY, PGEN<x>:CH<n>:TDELAY, PGEN<x>:CH<n>:THOLD, TBAS:PERIOD

**Syntax** PGEN<x>:CH<n>:WIDTH { MIN | MAX | <NRf> }  
PGEN<x>:CH<n>:WIDTH?

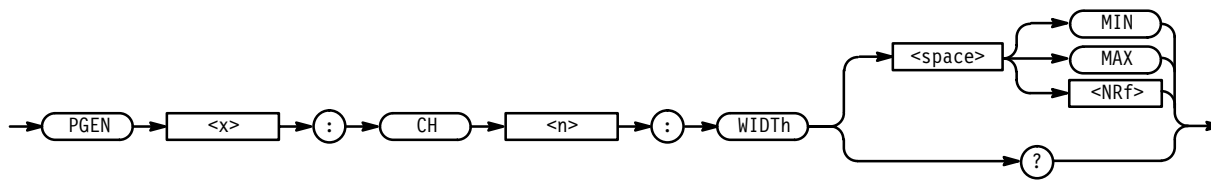

**Arguments** MIN sets the width to the minimum.

MAX sets the width to (channel period – minimum recovery width), where channel period is TBAS:PERiod if PGEN<x>:CH<n>:PRATe is either NORMAL or OFF, and channel period is 2 if PGEN<x>:CH<n>:PRATe is HALF. Minimum recovery width is 800 ps for both High Speed and Var Rate cards.

<NRf> sets the width to the specified value. Using a value outside the current legal range sets the width to the nearest legal value and gives an execution warning.

DCYClE and TDELay are coupled with WIDTh as follows:

- $DCYClE = (WIDTh * 100) / TBAS:PERiod$
- $TDELay = (LDELay + WIDTh)$

**Examples** PGENB:CH1:WIDT 2.5ns  
 sets the width of channel B1 to 2.5 ns.

PGENA:CH2:WIDT?  
 returns the width setting of channel A2.

## \*PSC

The \*PSC (Power-On Status Clear) command sets and queries the power-on status flag that controls the automatic power-on handling of the DESER, SRER, and ESER registers. When PSC is TRUE, the DESER register is set to 255 and the SRER and ESER registers are set to 0 at power-on. When PSC is FALSE, the current values in the DESER, SRER, and ESER registers are preserved in non-volatile memory when power is shut off and restored at power-on. For a complete discussion of the use of these registers, see page 3–129.

**Related Commands** DESE, \*ESE, FACTORY, \*RST, \*SRE.

**Syntax** \*PSC <NRf>  
 \*PSC?

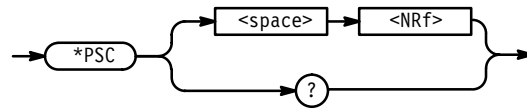

**Arguments** <NRf> is a value in the range from -32767 to 32767.

<NRf> = 0 sets the power-on status clear flag to FALSE, and disables the power-on clear and allows the HFS 9000 to assert SRQ after power-on.

<NRf> ≠ 0 sets the power-on status clear flag TRUE. Sending \*PSC 1 therefore enables the power-on clear and prevents any SRQ assertion after power-on. Using an out-of-range value causes an execution error.

**Examples** \*PSC 0  
 sets the power-on status clear flag to FALSE.

\*PSC?  
 might return the value 1, showing that the power-on status clear flag is set to TRUE.

## PURGE (No Query Form)

The PURGE command purges the contents of the selected save/recall register. This removes the settings stored using the \*SAV command. This performs the same function as the **Purge** item in the front-panel Save/Recall menu.

**Related Commands** \*SAV, \*RCL.

**Syntax** PURGE <NRf>

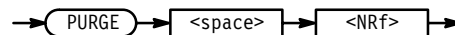

**Arguments** <NRf> is a value in the range from 1 to 30. Using an out-of-range value causes an execution error.

**Examples** PURGE 3  
 clears the contents of save/recall register 3.



## \*RCL (No Query Form)

The \*RCL (Recall) command restores the state of the HFS 9000 from a copy of its settings stored in local memory. (The settings are stored using the \*SAV command.) This performs the same function as the **Recall** item in the front-panel Save/Recall menu.

**Related Commands** \*LRN, \*RST, PURGE, \*SAV.

**Syntax** \*RCL <NRf>

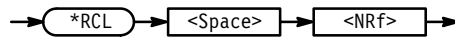

---

**NOTE.** \*RCL does not restore phase lock mode. After a recall, phase lock mode is always off because phase lock requires an external signal to be attached at the time phase lock is turned on. If your setting uses phase lock mode, recall the setting, connect the phase lock signal to the **PHASE LOCK IN** connector, and then turn on phase lock using the command `TBAS:PLIN:INP ON`.

---

**Arguments** <NRf> is a value in the range from 1 to 30. <NRf> recalls the state of the HFS 9000 from the specified local memory. Using an out-of-range value causes an execution error.

**Examples** \*RCL 3  
restores the HFS 9000 from a copy of the settings stored in local memory 3.

## RS232?

The RS232 command sets and queries the HFS 9000 RS-232-C interface parameters. RS232? queries all RS-232-C parameters.

**Syntax** RS232?

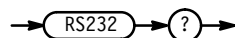

**Examples** RS232?  
might return the string `:RS232:BAUD 19200;PAR NONE;SBIT 1.00000;FLAG SOFT;ECHO 1;EOL CRLF;DEL 0.000000E+00.`

## RS232:BAUD

RS-232:BAUD sets and queries the RS-232-C transmit and receive baud rates. This performs the same function as the **Baud Rate** item in the front-panel RS-232 menu.

**Syntax** RS232:BAUD { 110 | 150 | 300 | 600 | 1200 | 2400 | 4800 | 9600 | 19200 }

RS232:BAUD?

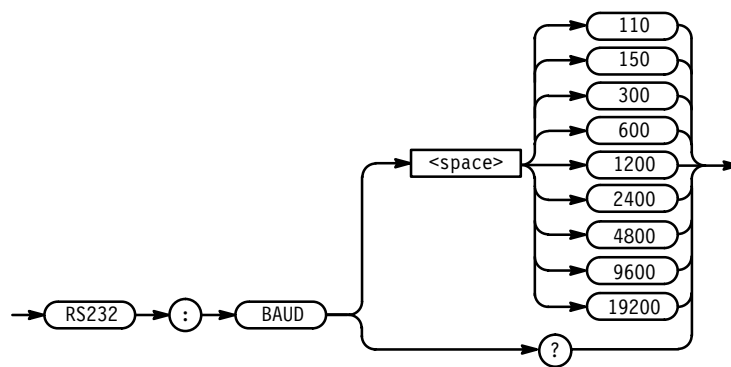

**Arguments** 110 sets the RS-232-C transmit and receive baud rates to 110, 150 sets the baud rates to 150, etc.

---

**NOTE.** Set the baud rate on the HFS 9000 before setting the baud rate on the controller.

---

**Examples** RS232:BAUD 19200  
sets the RS-232-C baud rate to 19,200.

RS232:BAUD?  
might return the value 4800, showing that the RS-232-C baud rate is set to 4800.

## RS232:DElAy

RS232:DElAy sets and queries the time that the HFS 9000 waits between receiving a query and sending the response. This performs the same function as the **Delay** item in the front-panel RS-232 menu.

**Syntax** RS232:DElay { MIN | MAX | <NRf> }

RS232:DElay?

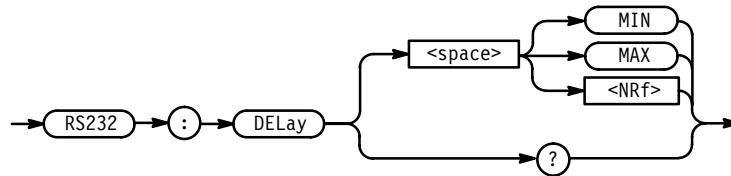

**Arguments** MIN sets the RS-232-C delay to 0 s.

MAX sets the RS-232-C delay to 60 s.

<NRf> is a value in the range from 0 to 60, in 50 ms increments. <NRf> sets the RS-232-C delay to the specified value. Using a value outside the current legal range sets the delay to the nearest legal value and gives an execution warning.

**Examples** RS232:DEL 2.5  
sets the RS-232-C delay to 2.5 s.

RS232:DEL?  
might return the value 5, showing that the RS-232-C delay is set to 5 s.

## RS232:ECHO

RS232:ECHO sets and queries the ECHO mode of the RS-232-C port. This performs the same function as the **Echo** item in the front-panel RS-232 menu.

**Syntax** RS232:ECHO { ON | OFF | <NRf> }

RS232:ECHO?

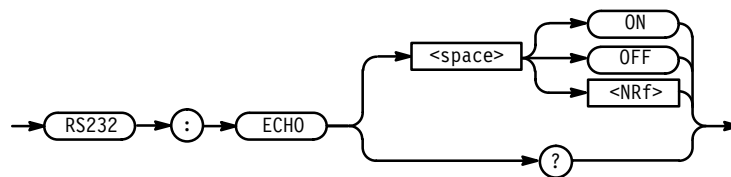

**Arguments** ON or <NRf> ≠ 0 turns on the echo of characters to the RS-232-C port.

OFF or <NRf> = 0 turns off the echo.

You cannot send binary data to the HFS 9000 when ECHO mode is ON. ECHO should be OFF if you use a computer program to transmit commands to the HFS 9000.

ECHO should be set to ON if you send commands interactively to the HFS 9000 using a CRT terminal, a hardcopy terminal, or a computer that is running terminal emulation software.

When ECHO is ON, it has the following effects on command input:

- Whenever the HFS 9000 is ready for the next command, it sends a ">" prompt to the controller. When this prompt appears on an RS-232-C device, enter a valid command or query and a terminator (CR or LF).
- All command input is buffered. Therefore, commands are not analyzed, executed, or displayed on the debug window until a terminator is received at the RS-232-C port. (When ECHO is OFF, input is processed as it is received.)
- Until the command is terminated, it may be edited with any of the following special characters:

CONTROL-R retypes the current input command and places the cursor to the right of the last character of the command.

CONTROL-U deletes the current command and reprompts for another input.

BACKSPACE and DELETE erase the last character entered.

BACKSLASH (\) places special editing characters (CR, LF, BACKSPACE, DELETE, CONTROL-R, CONTROL-U, and BACKSLASH) into the input buffer. To place a special character into the input buffer, enter \ followed by the special character. The \ is not echoed.

### Examples

RS232:ECHO ON  
turns the RS-232-C echo on.

RS232:ECHO?  
might return the string OFF, showing that the RS-232-C echo mode is turned off.

## RS232:EOL

RS232:EOL (end-of-line) selects or queries the RS-232-C end-of-line output message terminator. (The RS-232-C end-of-line input message terminator is a line feed.) This performs the same function as the **EOL** item in the front-panel RS-232 menu.

**Syntax:** RS232:EOL { CR | CRLF | LF | LFCR }  
 RS232:EOL?

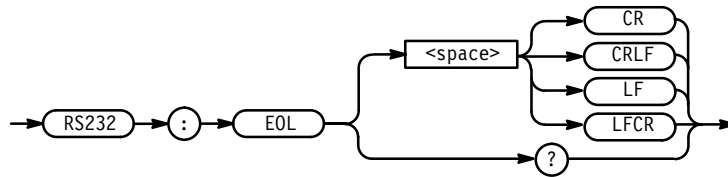

**Arguments** CR selects a carriage return as the output message terminator.  
 CRLF selects a carriage return followed by line feed.  
 LF selects a line feed.  
 LFCR selects a line feed followed by carriage return.

**Examples** RS232:EOL CR  
 selects a carriage return as the RS-232-C end-of-line terminator.  
 RS232:EOL LFCR  
 selects a line feed followed by carriage return as the RS-232-C end-of-line terminator.  
 RS232:EOL?  
 might return the string LF, showing that the RS-232-C end-of-line character is a line feed.

## RS232:FLAGging

RS232:FLAGging sets and queries the RS-232-C handshaking mode. This performs the same function as the **Flagging** item in the front-panel RS-232 menu.

**Syntax** RS232:FLAGging { HARD | SOFT | OFF }  
 RS232:FLAGging?

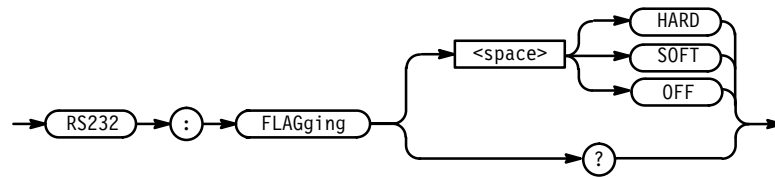

**Arguments** HARD sets the RS-232-C handshaking to use DTR and CTS control lines.  
 SOFT sets the RS-232-C handshaking to use XOn (DC1) and XOff (DC3).  
 OFF sets the RS-232-C handshaking to OFF (no transmission control).

**Examples** RS232:FLAG SOFT  
 sets RS-232-C handshaking to XOn/XOff.  
 RS232:FLAG OFF  
 turns RS-232-C handshaking off.  
 RS232:FLAG?  
 might return the string HARD, showing that the RS-232-C handshake is set to hard flagging.

## RS232:PARity

RS232:PARity sets and queries the RS-232-C parity setting. This performs the same function as the **Parity** item in the front-panel RS-232 menu.

**Syntax** RS232:PARity { ODD | EVEN | NONE | ZERO | ONE }  
 RS232:PARity?

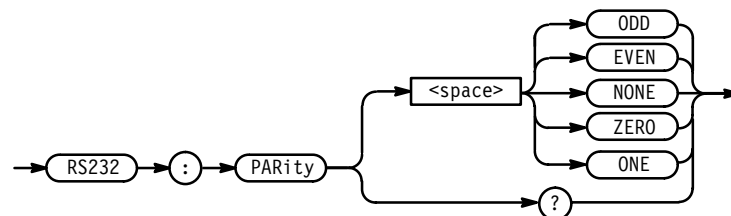

**Arguments** EVEN sets the RS-232-C parity to even.  
 ODD sets the RS-232-C parity to odd.  
 ZERO sets the RS-232-C parity to zero (or space).  
 ONE sets the RS-232-C parity to one (or mark).

NONE sets the RS-232-C parity to none.

---

**NOTE.** Parities *EVEN*, *ODD*, *ZERO*, and *ONE* add one bit of parity to seven bits of data. Parity *NONE* uses no parity and eight bits of data. The number of data and parity bits per character is eight regardless of the parity setting.

---

**Examples** RS232:PAR ODD  
sets the RS-232-C parity to odd.

RS232:PAR?  
might return the string EVEN, showing that the RS-232-C parity is set to even.

## RS232:SBITs

RS232:SBITs (Stop Bits) sets and queries the RS-232-C stop bits. This performs the same function as the **Stop Bits** item in the front-panel RS-232 menu.

**Syntax** RS232:SBITs { 1 | 1.5 | 2 }  
RS232:SBITs?

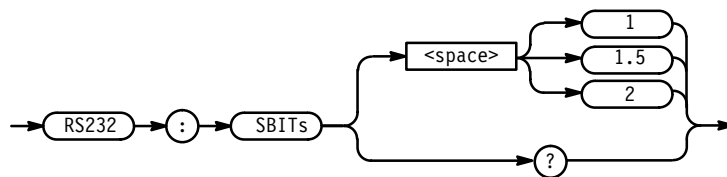

**Arguments** 1 sets the RS-232-C stop bits to 1.  
1.5 sets the RS-232-C stop bits to 1.5.  
2 sets the RS-232-C stop bits to 2.

**Examples** RS232:SBIT 1.5  
sets the RS-232-C stop bits to 1.5.

RS232:SBIT?  
might return the value 2, showing that the RS-232-C stop bits are set to 2.

## \*RST (No Query Form)

The \*RST (Reset) command returns the HFS 9000 to a known set of instrument settings, but does not purge any aliases or stored settings. This performs the same function as the **Reset** item in the front-panel Save/Recall menu.

The only difference between factory FACTORY command and \*RST is that \*RST does not purge any stored settings.

**Related Commands**    FACTORY, \*PSC.

**Syntax**    \*RST

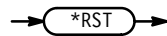

\*RST does the following:

- Puts the HFS 9000 into the Operation Complete Command Idle State.
- Puts the HFS 9000 into the Operation Complete Query Idle State.
- Returns the instrument settings to those listed under the FACTORY command (see page 3–36).

The \*RST command does not alter the following:

- The state of the RS-232-C or IEEE 488.1 interfaces.
- The selected IEEE 488.1 address of the HFS 9000.
- Calibration data that affects device specifications.
- The Output Queue.
- The Standard Status Register Enable setting.
- The Standard Event Status Enable setting.
- The Power-on status clear flag setting.
- Alias definitions.
- Stored settings.



## \*SAV (No Query Form)

The \*SAV (Save) command stores the state of the HFS 9000 into a selected local memory. This performs the same function as the **Save** item in the front-panel Save/Recall menu. You can later use the \*RCL command to restore the HFS 9000 to this saved state.

**Related Commands** \*RCL, PURGE.

**Syntax** \*SAV <NRf>

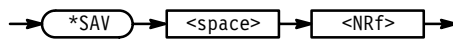

**Arguments** <NRf> is a value in the range from 1 to 30. Using an out-of-range value causes an execution error.

**Examples** \*SAV 2  
saves the current settings into local memory 2.

## SIGNAL:<parameter>

SIGNAL:<parameter> provides a method of setting pulse parameters by using signal names. Please refer to each individual pulse parameter supported for more information on parameter arguments.

**Supported Commands** AMPLitude, CDElay, COUtpuT, DCYCLe, HIGH, HLIMit, LDElay, LHOLd, LIMit, LLIMit, LOW, LVIEW, OFFSet, OUTPut, PHASe, POLarity, PRATe, TDElay, THOLd, TRANsition, WIDTh

**Syntax** SIGNAL:<parameter> <signal>,<value>  
SIGNAL:<parameter>? <signal>

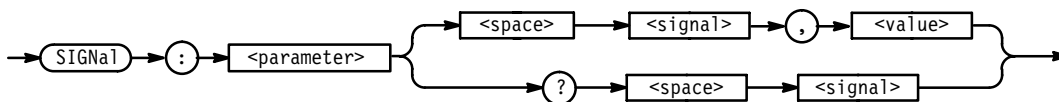

**Arguments** <parameter> identifies the pulse parameter to be set or queried.  
signal identifies the signal whose pulse parameter is to be set or queried.

---

value specifies the value of the specified pulse parameter.

**Examples**

SIGNAL:AMPLITUDE "A[]", 2V  
sets the amplitude for bus "A[]" to 2V.

SIGNAL:LDELAY "A[3:7]", 1ns  
sets the lead delay for pins 3–7 in "A[]" to 1 ns.

SIGNAL:LDELAY? "A[]"  
returns the lead delay for bus "A[]".

SIGNAL:DCYCLE "Clk", 50  
sets the duty cycle for signal "Clk" to 50%.

SIGNAL:OUTPUT "WE", ON  
turns on the output for signal "WE".

SIGNAL:LOW? "~G1"  
returns the low voltage level for signal "~G1".

---

**NOTE.** *Querying a signal which is a single pin will return the value for that pin. Querying a signal which is a bus will return the value associated with the earliest bit in that bus's channel order. This is the same value displayed by the front panel. If more than one value exists for the bus being queried, an execution warning will also be generated.*

---

## SIGNAL:BDATA

SIGNAL:BDATA (Signal Binary Data Input/Output) provides binary encoded data input/output for a single pin.

**Related Commands** PGEN<x>:CH<n>:BDATA, VECTOR:BIOFormat, VECTOR:BDATA

**Syntax** SIGNAL:BDATA <pin>,<address>,<count>,<block>

SIGNAL:BDATA? <pin>,<address>,<count>

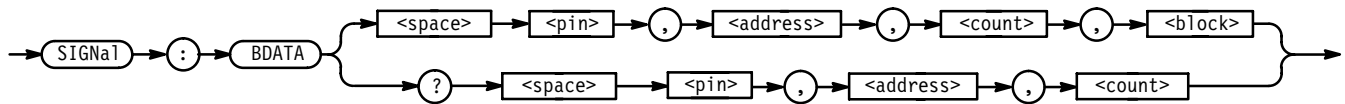

**Arguments** <pin> identifies the signal to be filled with data.  
 address specifies the start address for the data.  
 count specifies the number of data bits that follow or that should be returned.  
 <block> represents a block of binary bytes.

---

**NOTE.** Each byte in <block> contains eight data bits.

---

**Examples** SIGNAL:BDATA "~G1",0,16,#12G8  
 enters 16 bits of data into signal "~G1", starting at address 0.

Where:

- # is the block start character
- 1 is the number of digits in the length field
- 2 is the length field, it specifies the number of data bytes (eight bits per byte)

The sixteen bits of data are represented by "G8", where:

"G" = 01000111  
 "8" = 00111000

The following table illustrates how the data in the above example would be read into the channel memory. Note how each byte is read in from right to left. In other words, the least significant bit of each byte is read in first.

Address	Signals			
	A0	~G1	D0	WE
0000	x	1	x	x
0001	x	1	x	x
0002	x	1	x	x
0003	x	0	x	x
0004	x	0	x	x
0005	x	0	x	x
0006	x	1	x	x
0007	x	0	x	x
0008	x	0	x	x
0009	x	0	x	x
0010	x	0	x	x
0011	x	1	x	x
0012	x	1	x	x
0013	x	1	x	x
0014	x	0	x	x
0015	x	0	x	x

SIGNAL:BDATA? "WE",0,12

returns the first 12 bits of data (starting from address 0) from signal "WE".

## SIGNAL:BDATA:FILL

SIGNAL:BDATA:FILL (Binary Data Fill) provides a method of filling a signal with binary data.

**Related Commands** PGEN<x>:CH<n>:BDATA, VECTOR:BIOfFormat, VECTOR:BDATA

**Syntax** SIGNAL:BDATA:FILL <pin>,<address>,<count>,<binary byte>

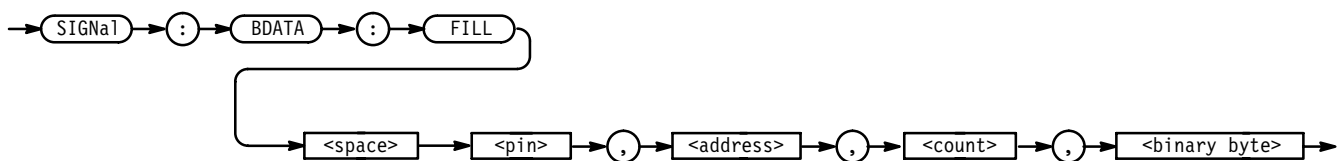

**Arguments** <pin> identifies the signal to be filled with data.

address sets the start address.

<binary byte> represents the data used to fill the channel.

count specifies the number of number of addresses to be filled. If <count> is less than eight, the rightmost <count> bits are used from the <binary byte>. If <count> is greater than eight, the <binary byte> is repeated the required number of time to satisfy <count>. Note that the byte is read from right to left, that is, the least significant bit is read first.

**Examples**

SIGNAL:BDATA:FILL "Addr0",0,1024, 0  
fills the first 1024 addresses of signal "Addr0" with all zeros.

SIGNAL:BDATA:FILL "~WE",0,1024, #HFF  
fills the first 1024 addresses of signal "~WE" with all ones.

SIGNAL:BDATA:FILL "Data7",0,512, #H55  
fills the first 512 addresses of signal "Data7" with alternating ones and zeros (that is: 101010101010...).

SIGNAL:BDATA:FILL "Data7",0,512, #HAA  
fills the first 512 addresses of signal "Data7" with alternating zeros and ones (that is: 010101010101...).

## SIGNAL:CVIEW

SIGNAL:CVIEW (Signal Channel View) controls whether signals are displayed individually (as a channel) or displayed as a group (a bus). This performs the same function as the **View** item in the Signal, Data Fill, Data Copy, and Vector menus.

**Related Commands**

PGEN<x>:CH<n>:CVIEW

**Syntax**

SIGNAL:CVIEW <signal>,{ GROUp | CHANne1 }

SIGNAL:CVIEW? <signal>

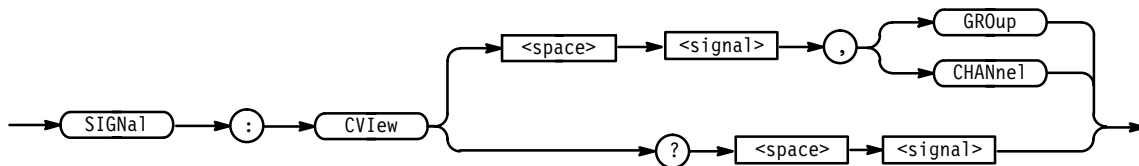

**Arguments**

signal is the name of the signal.

GRoup sets the channel display so that signals are viewed by their name.

<CHANne1> sets the channel display so that signals are viewed individually.

**Examples** SIGNAL:CVIEW "A[]", GROUP  
 sets the display of bus "A[]" to group; the group will be displayed by name rather than by card and channel number.

SIGNAL:CVIEW? "Clk"  
 returns the display setting for signal "Clk".

## SIGNAL:DATA

SIGNAL:DATA (Signal Data Input/Output) provides ascii encoded data input/output for a single pin. Only binary ascii is supported by this command; octal and hexadecimal data input/output (more appropriate for bus-oriented data) is supported by the :VECTOR commands.

**Related Commands** VECTor:IOFormat, VECTor:DATA,

**Syntax** SIGNAL:DATA <pin>,<address>,<count>,<ascii data>  
 SIGNAL:DATA? <pin>,<address>,<count>

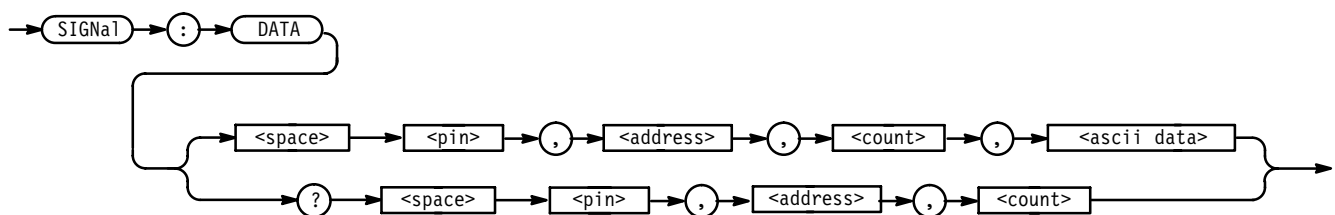

**Arguments** <pin> identifies the signal to be filled with data.  
 address sets/queries the start address for the data.  
 count specifies the number of data elements that follow or that should be returned.  
 <ascii data> represents the ascii-formatted binary data to be entered.

**Examples** SIGNAL:DATA "~G1",0,16,"1110001000011100"  
 enters 16 bits of data into signal "~G1", starting at address 0.

SIGNAL:DATA? "WE",0,12?  
 returns the first 12 bits of data (starting from address 0) from signal "WE".

## SIGNAL:DATA:COPY

SIGNAL:DATA:COPY (Signal Data Copy) copies data from one signal to another. The source and destination signals may be the same signals. This command performs the same function as the **Copy Block to Dest** item in the Data Copy menu.

**Related Commands** PGEN<x>:CH<n>:DATA:COPY

**Syntax** SIGNAL:DATA:COPY <pin1>,<address1>,<count>,<pin2>,<address2>

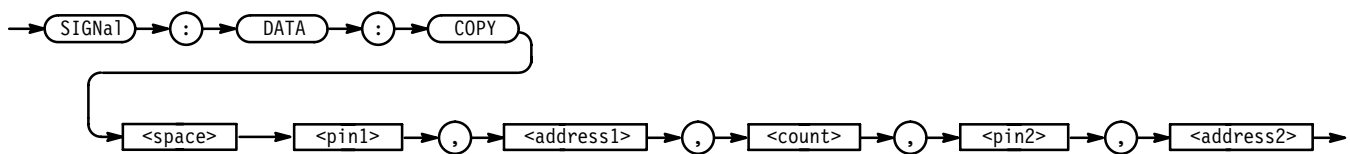

- Arguments**
- <pin1> identifies the destination channel.
  - <address1> specifies the destination address.
  - count specifies the number of data elements to be copied.
  - <pin2> specifies the source channel.
  - <address2> represents the source address.

**Examples** SIGNAL:DATA:COPY "Addr0",0,512,"Addr1",1024  
 copies 512 data bits from signal "Addr1", address 1024, to signal "Addr0", address 0.

## SIGNAL:DATA:SWAP

SIGNAL:DATA:SWAP (Signal Data Swap) swaps blocks of data between signals.

**Related Commands** PGEN<x>:CH<n>:DATA:SWAP

**Syntax** SIGNAL:DATA:SWAP <pin1>,<address1>,<count>,<pin2>,<address2>

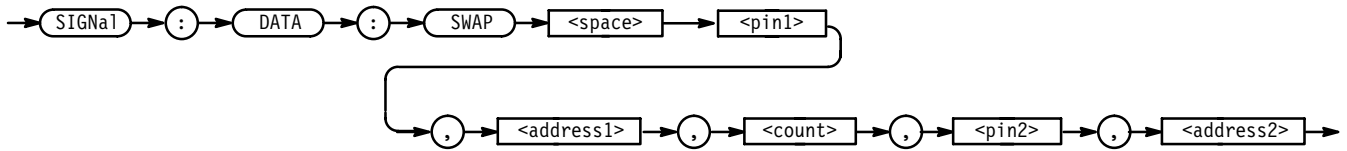

- Arguments**
- <pin1> specifies the signal to which data is swapped; in other words, this argument identifies the destination signal.
  - address1 sets the destination address.
  - count specifies the number of data elements to be swapped.
  - <pin2> specifies the signal from which data is to be swapped; it identifies the source signal.
  - <address2> identifies the beginning of the block of data to be swapped.

**Examples** SIGNAL:DATA:SWAP "Data3",512,10,"Data1",0  
 swaps 10 bits of data from signal "Data1", address 0, with signal "Data3", address 512.

## SIGNAL:DRADix

SIGNAL:DRADix (Signal Data Radix) controls how signal data is displayed on the front panel. This command performs the same function as the **Data Radix** item in the front-panel Data Fill menu.

**Syntax** SIGNAL:DRADix <signal>,{ OCT | DEC | HEX }

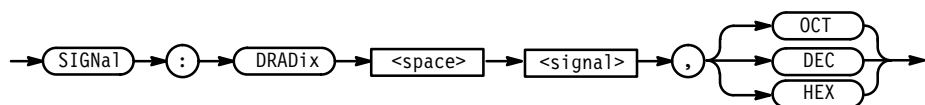

- Arguments**
- <signal> identifies the signal whose data radix is to be set or queried.
  - <OCT> specifies an octal data radix.
  - <DEC> specifies a decimal data radix.
  - <HEX> specifies a hexadecimal data radix.

**Examples** SIGNAL:DRADIX "A[ ]",HEX  
 sets the data radix for signal "A[ ]" to hexadecimal.



SIGNAL:DRADIX? "Clk"  
 returns the data radix for signal "Clk".

## SIGNAL:TYPE

SIGNAL:TYPE (Signal Type) specifies the type of output for the specified channel. This performs the same function as the **Signal Type** item in the Signal and Pulse menus.

**Related Commands** PGEN<x>:CH<n>:TYPE

**Syntax** SIGNAL:TYPE <signal>,{ NRZ | RZ | R1 | PULSe | DC | TRANSDucer }  
 SIGNAL:TYPE? <signal>

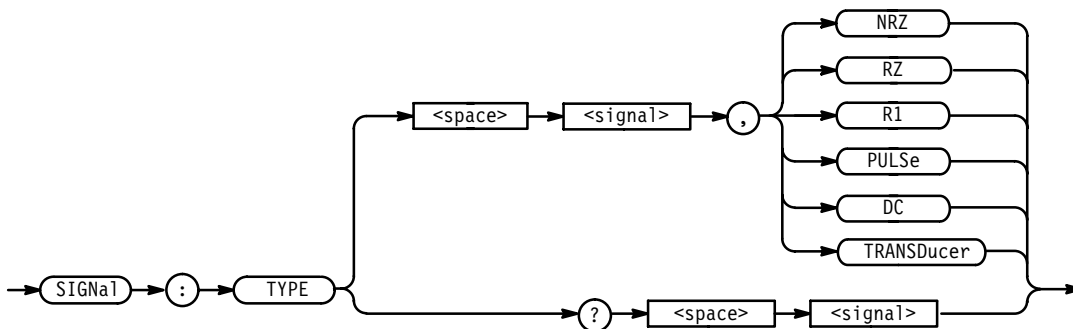

**Arguments** NRZ sets the signal type to “Non–Return to Zero”.  
 RZ sets the signal type to “Return to Zero”.  
 R1 sets the signal type to “Return to One”.  
 PULSe sets the signal type to Pulse.  
 DC sets the signal type to DC.  
 TRANSDucer sets the signal type to transducer.

**Examples** SIGNAL:TYPE "A[]", NRZ  
 sets the signal type of bus “A[ ]” to non-return to zero.  
 SIGNAL:TYPE "CLK", PULSE  
 sets the signal type of channel “CLK” to pulse.  
 SIGNAL:TYPE? "A0"  
 returns the signal type of channel “A0”.

## \*SRE

The \*SRE (Service Request Enable) command sets and queries the bits in the Service Request Enable Register (SRER). For a complete discussion of the use of these registers, see page 3–129.

**Related Commands** \*CLS, DESE, \*ESE, \*ESR, EVENT?, EVMSG?, FACTORY, \*PSC, \*STB.

**Syntax** \*SRE <NRf>

\*SRE?

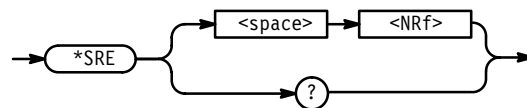

**Arguments** <NRf> is a value in the range from 0 to 255. The binary bits of the SRER are set according to this value. Using an out-of-range value causes an execution error.

The power-on default for SRER is 0 if \*PSC is 1. If \*PSC is 0, the SRER maintains its value through a power cycle.

**Examples** \*SRE 48  
sets the bits in the SRER to 00110000 binary.

\*SRE?  
might return a value of 32, showing that the bits in the SRER have the binary value 00100000.

## \*STB? (Query Only)

The \*STB? (Read Status Byte) query returns the Status Byte Register (SBR) using the Master Summary Status (MSS) bit. For a complete discussion of the use of these registers, see page 3–129.

**Related Commands** \*CLS, DESE, \*ESE, \*ESR, EVENT?, EVMSG?, FACTORY, \*SRE.

**Syntax** \*STB?

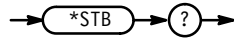

**Examples** \*STB?  
 might return the value 96, showing that the STB contains the binary value 01100000.

## TBAS?

The TBAS (Time Base) command sets and queries the HFS 9000 time base parameters. The query TBAS? returns the values of all time base parameters.

**Related Commands** TBAS:PLIN, TBAS:TIN, TBAS:TOUT.

**Syntax** TBAS?

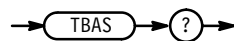

**Examples** TBAS?  
 might return the string  
 :TBAS:MODE AUTO;PVI PER;PER 5.0E-09;COUN 64;TIN:INP 1;SLOP  
 POS;LEV -1.3E+00;:TBAS:PLIN:INP 0;:TBAS:TOUT:PER 1;PRET  
 7.0E-08

## TBAS:COUNT

TBAS:COUNT sets and queries the time base burst count. This performs the same function as the **Count** item in the front-panel Time Base menu.

**Syntax** TBAS:COUNT { MIN | MAX | <NRf> }

TBAS:COUNT?

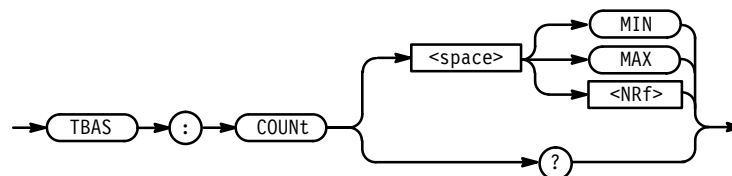

**Arguments** MIN sets the time base burst count to 1.

MAX sets the time base burst count to the maximum count.

<NRf> sets the time base count to the specified value. Using a value outside the current legal range sets the time base count to the nearest legal value and gives an execution warning.

**Examples**

TBAS:COUN MIN

sets the time base burst count to 1.

TBAS:COUN 30

sets the time base burst count to 30.

TBAS:COUN?

might return the value 15, showing that the time base burst count is set at 15.

## TBAS:FREQuency

TBAS:FREQ sets and queries the time base frequency. This performs the same functions as the **Frequency** item in the front-panel Time Base menu or Pulse menu.

**Related Commands**

TBAS:PERiod, TBAS:PVIew

**Syntax**

TBAS:FREQuency { MIN | MAX | <NRf> }

TBAS:FREQuency?

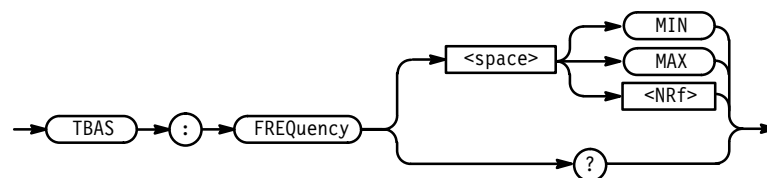

**Arguments**

MIN sets the time base frequency to the minimum.

MAX sets the time base frequency to the maximum.

<NRf> sets the time base frequency to the specified value. Using a value outside the current legal range sets the time base frequency to the nearest legal value and gives an execution warning.

FREQuency is the inverse of PERiod:  $FREQuency = 1 / PERiod$ .

- Examples** TBAS:FREQ 100E+6  
sets the time base frequency to 100 MHz.
- TBAS:FREQ?  
might return the string 450E+6, showing that the time base frequency is set to 450 MHz.

## TBAS:MODE

TBAS:MODE sets and queries the time base mode. This performs the same function as the **Mode** item in the front-panel Time Base menu.

- Syntax** TBAS:MODE { AUTO | ABURSt | BURSt | TAUTO }  
TBAS:MODE?

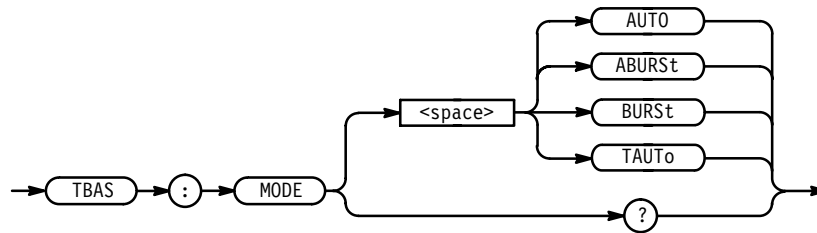

- Arguments** AUTO sets the time base to auto mode.
- ABURSt sets the time base to auto-burst mode.
- BURSt sets the time base to burst mode.
- TAUTO sets the time base to auto mode, but not until a trigger is received.

- Examples** TBAS:MODE AUTO  
sets the time base mode to auto.
- TBAS:MODE TAUTO  
sets the time base mode to triggered auto.
- TBAS:MODE ABUR  
sets the time base mode to auto-burst.
- TBAS:MODE?  
might return the string BURS, showing that the time base is set to burst mode.

## TBAS:PERiod

TBAS:PERiod sets and queries the time base period. This performs the same function as the **Period** item in the front-panel Time Base menu or Pulse menu.

**Related Commands** PGEN<x>:CH<n>:DCYClE, PGEN<x>:CH<n>:LDELay, PGEN<x>:CH<n>:TDELay, PGEN<x>:CH<n>:THOLd, PGEN<x>:CH<n>:WIDTh, TBAS:FREQUency, TBAS:PVlew

**Syntax** TBAS:PERiod { MIN | MAX | <NRf> }  
TBAS:PERiod?

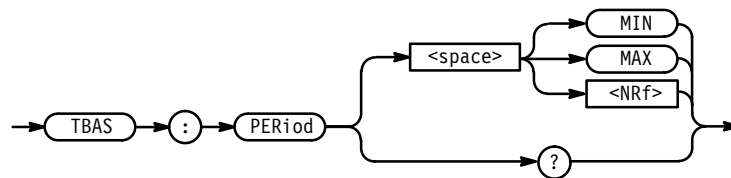

**Arguments** MIN sets the time base period to the minimum.  
MAX sets the time base period to the maximum.  
<NRf> sets the time base period to the specified value. Using a value outside the current legal range sets the time base period to the nearest legal value and gives an execution warning.  
PERiod is the inverse of FREQUency:  $PERiod = 1 / FREQUency$ .

**Examples** TBAS:PER MIN  
sets the time base period to the minimum.  
TBAS:PER?  
might return the value 10E-6, showing that the time base period is set to 10 μs.

## TBAS:PVlew

TBAS:PVlew (Period View) sets and queries the front-panel period display view. This performs the same function as **Select** and the **Period** or **Frequency** items in the front-panel Time Base menu and Pulse menu.

**Syntax** TBAS:PVIew { PERiod | FREQuency }

TBAS:PVIew?

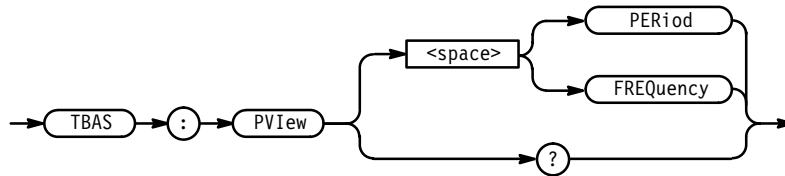

**Arguments** PERiod sets the frequency/period display view to period.

FREQuency sets the frequency/period display view to frequency.

**Examples** TBAS:PVI PER  
sets the period display view to period.

TBAS:PVI?  
might return the string FREQ, showing that the period display view is set to frequency.

## TBAS:PLIN?

The TBAS:PLIN command sets and queries the HFS 9000 phase lock parameters.

**Related Commands** TBAS, TBAS:TIN, TBAS:TOUT.

**Syntax** TBAS:PLIN?

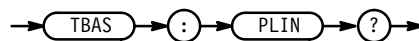

**Examples** TBAS:PLIN?  
might return the string :TBAS:PLIN:INP 0.

## TBAS:PLIN:INPut

TBAS:PLIN:INPut enables, disables, or queries the state of phase lock. This performs the same function as the **PhaseLockIn** item in the front-panel Time Base menu.

**Related Commands** TBAS, TBAS:TIN, TBAS:TOUT.

**Syntax** TBAS:PLIN:INPut { ON | OFF | <NRf> }  
 TBAS:PLIN:INPut?

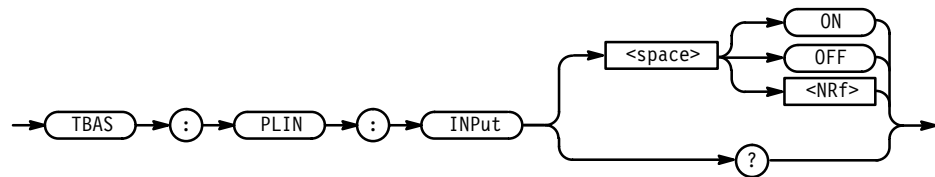

**Arguments**

ON or <NRf> ≠ 0 enables phase lock.

OFF or <NRf> = 0 disables phase lock.

**Examples** TBAS:PLIN:INP ON  
 enables phase lock.

TBAS:PLIN:INP?  
 might return the value 0, showing that phase lock is disabled.

## TBAS:RUN

TBAS:TRUN starts and stops the timebase. This performs the same function as the **RUN/STOP** button on the front panel.

**Syntax** TBAS:RUN { ON | OFF }  
 TBAS:RUN?

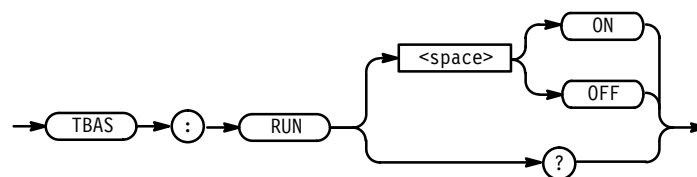

**Arguments** ON starts the timebase running.  
 OFF stops the timebase.



- Examples**
- TBAS:RUN ON  
starts the timebase.
  - TBAS:RUN OFF  
stops the timebase.
  - TBAS:RUN?  
returns the state of the timebase.

## TBAS:TIN?

The TBAS:TIN (Time Base Trigger In) command sets and queries the time base Trigger In parameters. TBAS:TIN? queries all Trigger In parameters.

**Related Commands** TBAS, TBAS:PLIN, TBAS:TOUT.

**Syntax** TBAS:TIN?

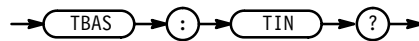

- Examples**
- TBAS:TIN?  
might return the string :TBAS:TIN:INP 1;SLOP POS;LEV -1.300000E+00.

## TBAS:TIN:INPut

TBAS:TIN:INPut enables, disables, or queries the **TRIGGER IN** connector. This performs the same function as the **Trigger In** item in the front-panel Time Base menu.

**Syntax** TBAS:TIN:INPut { ON | OFF | <NRf> }

TBAS:TIN:INPut?

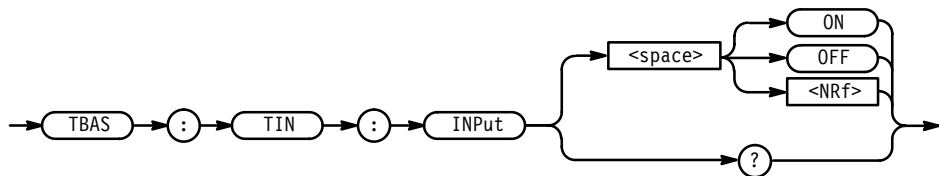

**Arguments** ON or <NRf> ≠ 0 enables trigger in.  
 OFF or <NRf> = 0 disables trigger in.

**Examples** TBAS:TIN:INP ON  
 enables the trigger in.  
 TBAS:TIN:INP?  
 might return the value 1, showing that trigger in is enabled.

## TBAS:TIN:LEVe1

TBAS:TIN:LEVe1 sets and queries the Trigger In level. This performs the same function as the **Trig Level** item in the front-panel Time Base menu.

**Syntax** TBAS:TIN:LEVe1 { MIN | MAX | <NRf> }  
 TBAS:TIN:LEVe1?

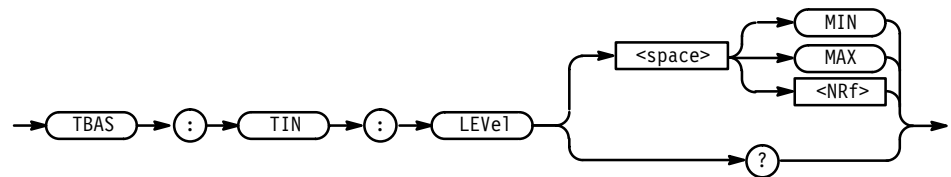

**Arguments** MIN sets the Trigger In level to the minimum.  
 MAX sets the Trigger In level to the maximum.  
 <NRf> sets the Trigger In level to the specified value. Using a value outside the current legal range sets the Trigger In level to the nearest legal value and gives an execution warning.

**Examples** TBAS:TIN:LEV 4  
 sets the Trigger In level to 4 V.  
 TBAS:TIN:LEV?  
 might return 2.5, showing that the Trigger In level is set to 2.5 V.

## TBAS:TIN:SLOPe

TBAS:TIN:SLOPe sets and queries the Trigger In slope. This performs the same function as the **Trig Slope** item in the front-panel Time Base menu.

**Syntax** TBAS:TIN:SLOPe { POSitive | NEGative }  
 TBAS:TIN:SLOPe?

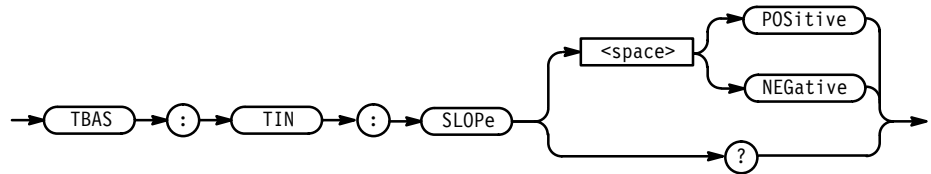

**Arguments** POSitive sets the Trigger In slope to positive edge triggering.  
 NEGative sets the Trigger In slope to negative edge triggering.

**Examples** TBAS:TIN:SLOP POS  
 sets the Trigger In slope to positive edge triggering.  
 TBAS:TIN:SLOP?  
 might return the string NEGATIVE, showing that the Trigger In slope is set to negative edge triggering.

### TBAS:TIN:TRIGger (No Query Form)

TBAS:TIN:TRIGger simulates the detection of a trigger event on the **TRIGGER IN** signal. This performs the same function as the **MANUAL TRIGGER** button on the front panel.

**Syntax** TBAS:TIN:TRIGger [ <count> ]

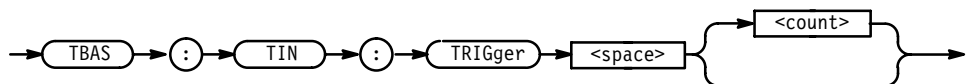

**Arguments** <count> sets the number of times a trigger event occurs. If no <count> value is specified, a <count> equal to 1 is assumed.

**Examples** TBAS:TIN:TRIGGER  
 triggers the timebase one time.  
 TBAS:TIN:TRIGGER 100  
 triggers the timebase 100 times.

## TBAS:TOUT?

The TBAS:TOUT (Time Base Trigger Out) command sets and queries the time base Trigger Out parameters. TBAS:TOUT? queries all Trigger Out parameters.

**Related Commands** TBAS, TBAS:PLIN, TBAS:TIN.

**Syntax** TBAS:TOUT?

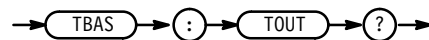

**Examples** TBAS:TOUT?  
 might return the string :TBAS:TOUT:PER 1;DESK 0.000000E+00.

## TBAS:TOUT:PERiod

TBAS:TOUT:PERiod sets and queries the Trigger Out period. This performs the same function as the **Out Period** item in the front-panel Time Base menu.

**Syntax** TBAS:TOUT:PERiod { MIN | MAX | <NRf> }

TBAS:TOUT:PERiod?

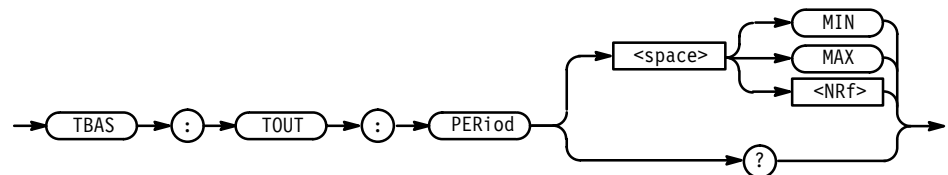

**Arguments** MIN sets the Trigger In level to 1.

MAX sets the Trigger In level to the value of TBAS:COUNt.

<NRf> outputs a Trigger Out signal on the specified pulse window in the burst.

**Examples** TBAS:TOUT:PER 9  
 outputs Trigger Out on the ninth pulse window in the burst.

TBAS:TOUT:PER?  
 might return the value 3, showing that the Trigger Out signal is output on the third pulse window in the burst.

## TBAS:TOUT:PRETrigger

TBAS:TOUT:PRETrigger sets and queries the Trigger Out pretrigger time. This performs the same function as the **Pretrigger** item in the front-panel Cal/Deskew menu.

**Syntax** TBAS:TOUT:PRETrigger { MIN | MAX | <NRf> }  
 TBAS:TOUT:PRETrigger?

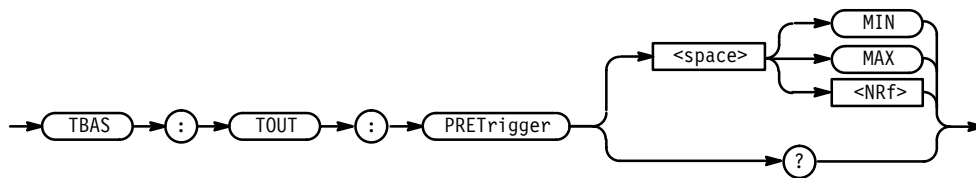

**Arguments** MIN sets the Trigger Out pretrigger to the minimum.

MAX sets the Trigger Out pretrigger to the maximum.

<NRf> sets the Trigger Out pretrigger to the specified value. Using a value outside the current legal range sets the Trigger Out pretrigger to the nearest legal value and gives an execution warning.

**Examples** TBAS:TOUT:PRET MIN  
 sets the Trigger Out pretrigger to the minimum.

TBAS:TOUT:PRET 50E-9  
 sets the Trigger Out pretrigger to 50 ns.

TBAS:TOUT:PRET?  
 might return the value 29E-9, showing that the Trigger Out pretrigger is set to 29 ns.

## \*TRG (No Query Form)

The \*TRG (Trigger) command executes a TBAS:TIN:TRIGger command.

The Group Execute Trigger (GET) interface message has the same effect as the \*TRG command.

**Syntax** \*TRG

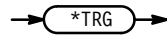

## \*TST? (Query Only)

The \*TST? (Self-Test) query runs the HFS 9000 internal self-test and reports the results. The self-test does not require operator interaction and does not create bus conditions that violate IEEE 488.1/488.2 standards. When complete, the HFS 9000 returns to the state it was in just prior to the self-test. This performs the same function as the **Self Test** item in the front-panel Cal/Deskew menu. The test response is a value <NR1> as described in Table 3–10.

**Syntax** \*TST?



---

**NOTE.** The \*TST? query can take 30 seconds or more to respond.

---

**Table 3–10: Results from \*TST?**

<NR1>	Meaning
0	test completed with no errors detected
SSCC	system which slot and card produced the first detected error:  SS = slot number: 01 = CPU slot 02 = time base slot 03 = slot A 04 = slot B ...  CC = card type: 10 = CPU card 20 = time base card 31 = HFS 9PG1 card 32 = HFS 9PG2 card 33 = HFS 9DG1 card 34 = HFS 9DG2 card
9900	system configuration is not valid

---

**NOTE.** If an error is detected, \*TST? stops and returns an error code; it does not complete any remaining tests.

---

**Examples** \*TST?  
 might return the value 220, showing that the time base card in the time base slot has an error. If the test returned the value 431, the High Speed Pulse card in Slot B would have an error.

## VECTor?

The VECTor? command queries the vector parameters.

**Related Commands** VECTor:START, VECTor:LOOP, VECTor:END

**Syntax** VECTor?

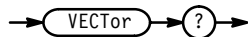

**Examples** VECTOR?  
 returns the vector parameters in the following format:  
 “VECTOR: START 0; LOOP 0; END 7” .

## VECTor:BDATA

VECTor:BDATA (Vector Binary Data Input/Output) is used to input and output vectors according to the BIOFORMAT command. This is the fastest method for downloading data. Because this command should always be used in conjunction with the VECTor:BIoFormat, the examples given below use both a BIOFormat command as well as one or more BDATA commands.

**Related Commands** PGEN<x>:CH<n>:BDATA, VECTor:IOFormat

**Syntax** VECTor:BDATA <address>,<count>,<block>

VECTor:BDATA? <address>,<count>

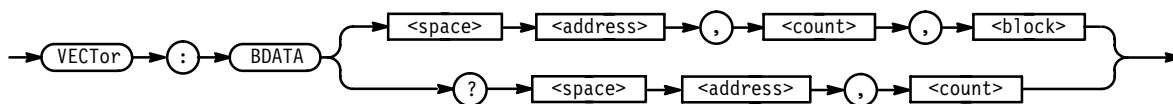

**Arguments** <address> sets/queries the start address for the data.

<count> specifies the number of data elements that follow or that should be returned.

<block> represents a block of binary bytes.

### Examples

```
VECTOR:BIOFORMAT "Addr0"  
VECTOR:BDATA 0,16,#12aJ
```

The BIOFORMAT command specifies that data will load into “Addr0” only. The BDATA command enters 16 bits of data into signal “Addr0”, starting at address 0.

```
VECTOR:BIOFORMAT "Data[3:0]"  
VECTOR:BDATA 0,16,#18aabbccdd  
VECTOR:BDATA 16,16,#18eeffgghh
```

The BIOFORMAT command specifies that data will load into four pins: “Data3”, “Data2”, “Data1”, and “Data0”.

The first BDATA command enters 16 bits of data, starting at address 0. (see Figure 3–9). The second BDATA command loads another 16 bits of data, starting at address 16.

“Data3” gets bytes aae.  
“Data2” gets bytes bbff.  
“Data1” gets bytes ccgg.  
“Data0” gets bytes ddhh.

Each pin’s data is loaded starting at address 0, with 16 bits as specified by the <address> of 0 and <count> of 16. To load 16 bits of data per pin requires 2 bytes per channel or 8 bytes total. The #18 specifies that 8 bytes of data are in the binary block. The pins are loaded in order as specified by the previous BIOFORMAT command.



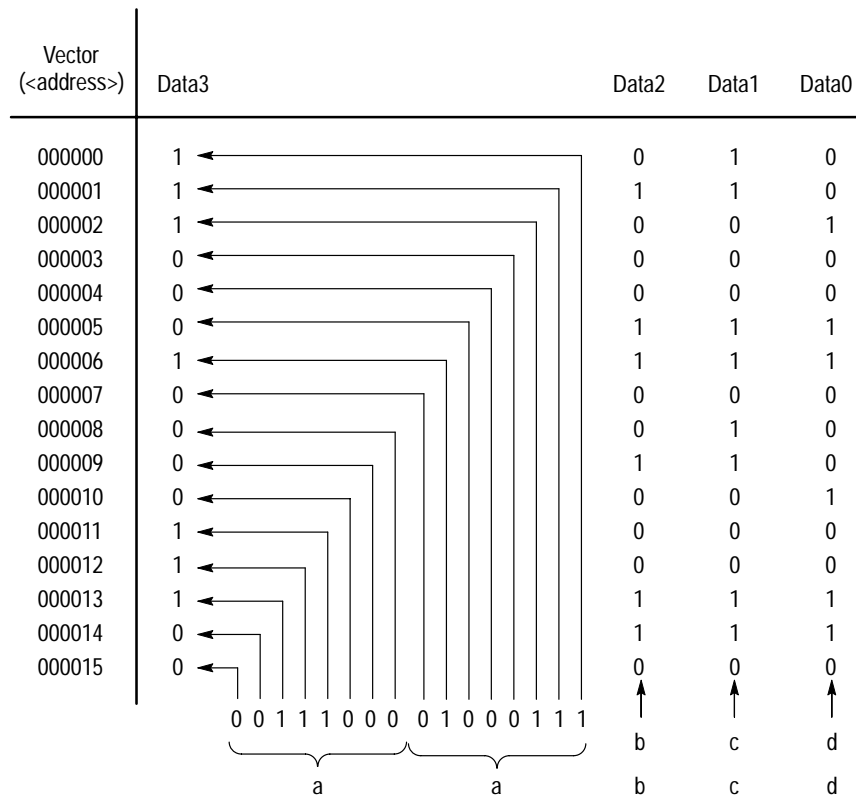
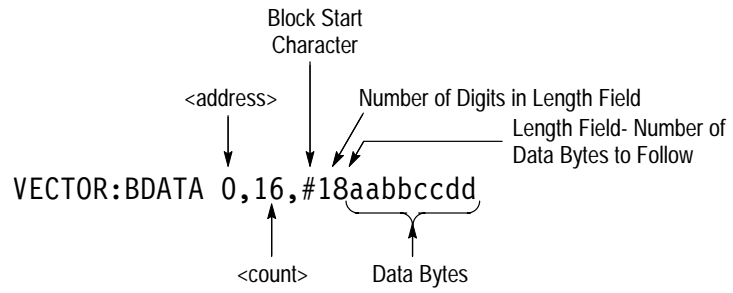

Figure 3-9: Reading Binary Encoded Data into Vectors

## VECTor:BIOfORMAT

VECTor:BIOfORMAT (Vector Binary Input/Output Format) specifies the signals (named channels) to receive binary data supplied in subsequent VECTor:BDATA commands.

**Related Commands** PGEN<x>:CH<n>:BDATA

**Syntax** VECTor:BIOfORMAT <signal> [ , <signal>... ]  
 VECTor:BIOfORMAT?

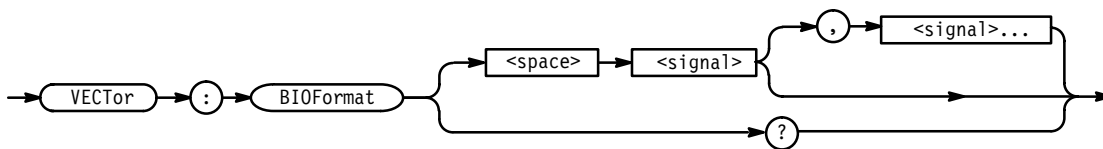

**Arguments** signal identifies the signal(s) to receive the data provided by subsequent BDATA commands.

**Examples** VECTor:BIOfORMAT "Addr[0:7]"  
 sets the binary input/output format to bus "ADDR[0:7]".

## VECTor:DATA

VECTor:DATA (Vector Data Input/Output) is used to input and output vectors specified by the VECTor:IOFORMAT command. Because this command should always be used in conjunction with the VECTor:IOFormat, the examples given below use both a VECTor:IOFormat command as well as one or more DATA commands.

**Related Commands** PGEN<x>:CH<n>:DATA

**Syntax** VECTor:DATA <address>,<count>,<ascii data>  
 VECTor:DATA? <address>,<count>

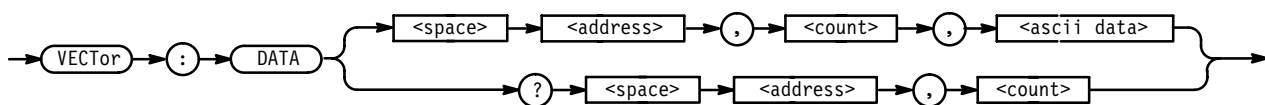

**Arguments**     <address> sets/queries the start address for the data.

                    <count> specifies the number of data elements that follow or that should be returned.

                    <block> represents a block of data bytes, formatted in hexadecimal.

**Examples**     VECTOR:IOFORMAT "A[0:7]", HEX  
                     VECTOR:DATA 0,12,"010101010202020201010101"

                    The IOFORMAT command specifies that data will load into "A[0:7]" and be formatted in hexadecimal.

                    The DATA command enters 12 bits of data into signal "Addr0", "Addr1", "Addr2", . . . "Addr7", starting at address 0.

VECTOR:IOFORMAT "WE", BIN  
 VECTOR:DATA 0,4, "0011"

                    The IOFORMAT command specifies that data will load into one pin, "WE". The data for "WE" will be read in as binary.

VECTOR:IOFORMAT "~G1", BIN  
 VECTOR:DATA? 0,4

                    The IOFORMAT command specifies that the data at pin "~G1" is in binary format. The data command will return the data for 4 vectors starting at address 0.

VECTOR:IOFORMAT "D[3:0]", HEX, "WE", BIN  
 VECTOR:DATA 0,4, "A0A0A1A1"

                    The IOFORMAT command specifies that data will load into five pins: "D3", "D2", "D1", "D0", and "WE". The data for "D[3:0]" will be read in as hex and the data for "WE" will be read in as binary. See Figure 3–10.



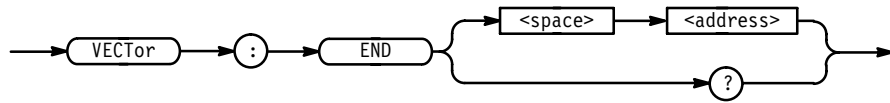

**Arguments** address sets the vector end address.

**Examples** VECTOR:END 16  
sets the vector end address to 16.

VECTOR:END?  
returns the vector end address.

## VECTor:IOFormat

VECTor:IOFormat (Vector Input/Output Format) sets the format to be used by subsequent VECTor:DATA commands. This command specifies the radix of the vectors being input or output, and which signals the vectors are mapped to. This is a flexible command that allows vectors to be input or output in any radix or combination. Vectors can be input for every signal in the Data Generator or for any subset of signals. Vectors can be addressed all the way down to a single bit. When specifying how buses will be formatted, note that bit order is important. The specification D[3:0] is not the same as D[0:3]. D[0:3] states that the most significant bit is associated with D[0], while D[3:0] states that the most significant bit is associated with D[3].

**Syntax** VECTor:IOFormat <signal>,<radix>[,<signal>,<radix>... ]

VECTor:IOFormat?

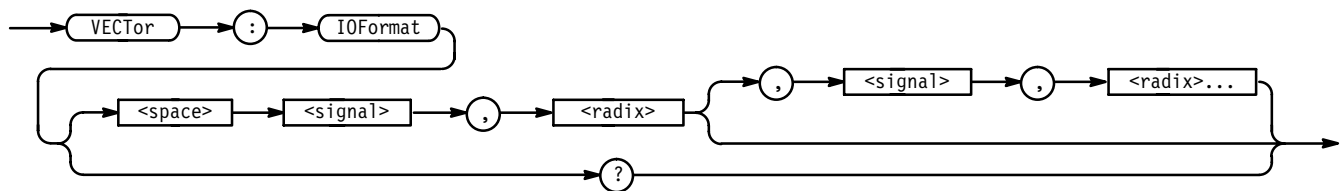

**Arguments** <signal> identifies the signal(s) to receive the data provided by subsequent BDATA commands.

<radix> sets the format of the data to be entered.

**Examples** VECTOR:IOFORMAT "A[0:7]", HEX  
identifies the signal "A[0:7]" to receive data from the subsequent VECTor:Data command and set the data format to hex.

VECTOR:IOFORMAT "D[3:0]", HEX, "WE", BIN  
 identifies two signals, "D[3:0]" and "WE", to receive data from the subsequent VECTOR:Data commands. "D[3:0]" will receive data in hex format, while "WE" will receive data in binary format.

## VECTOR:LOOP

The VECTOR:LOOP (Vector Loop Back Address) sets the vector loop back address. This performs the same function as the **Loop** item in the Vector menu.

**Syntax** VECTOR:LOOP <address>

VECTOR:LOOP?>

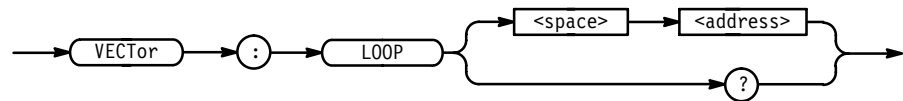

**Arguments** <address> sets the vector loop address.

**Examples** VECTOR:LOOP 8  
 sets the vector loop address to 8.

VECTOR:LOOP?  
 returns the vector loop address.

## VECTOR:START

The VECTOR:START (Vector Start Address) sets the vector start address. This performs the same function as the **Start** item in the Vector menu.

**Syntax** VECTOR:START <address>

VECTOR:START?>

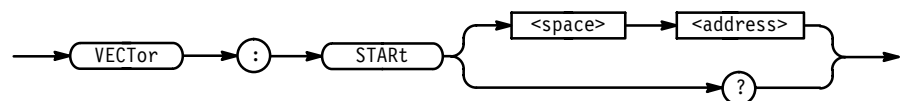

- Arguments** address sets the start address.
- Examples** VECTOR:START 0  
sets the vector start address to 0.
- VECTOR:START?  
returns the vector start address.

## VERBOSE

The VERBOSE command sets and queries the Verbose Header State that controls the length of headers on query responses. This command does not affect IEEE 488.2 Common Commands (those starting with an asterisk).

**Related Commands** HEADER, \*LRN?.

**Syntax** VERBOSE { ON | OFF | <NRf> }  
VERBOSE?

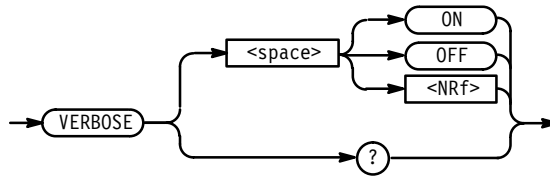

**Arguments** ON or <NRf> ≠ 0 sets the Verbose Header State TRUE, which returns full-length headers for applicable setting queries.

OFF or <NRf> = 0 sets the Verbose Header State FALSE, which returns minimum-length headers for applicable setting queries.

**Examples** VERBOSE ON  
sets the Verbose Header State TRUE.

VERBOSE?  
might return the value 1, showing that the Verbose Header State is TRUE.

## \*WAI (No Query Form)

The \*WAI (Wait) command prevents the HFS 9000 from executing further commands or queries until all pending operations finish.

**Related Commands** \*OPC.

**Syntax** \*WAI

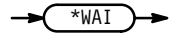





# Status and Events

The HFS 9000 provides a status and event reporting system for the GPIB and RS-232-C interfaces. This system informs you of significant events that occur within the HFS 9000.

The HFS 9000 status handling system consists of five 8-bit registers and two queues. This section describes these registers and components, and explains how the event handling system operates.

## Registers

The registers in the event handling system fall into two functional groups:

- The Standard Event Status Register (SESR) and the Status Byte Register (SBR) contain information about the status of the HFS 9000. These registers are therefore called the Status Registers.
- The Device Event Status Enable Register (DESER), the Event Status Enable Register (ESER), and the Service Request Enable Register (SRER) determine whether selected types of events are reported to the Status Registers and the Event Queue. These three registers are called the Enable Registers.

### Status Registers

The Standard Event Status Register (SESR) and the Status Byte Register (SBR) record certain types of events that may occur while the HFS 9000 is in use. These registers are defined by IEEE Standard 488.2-1987.

Each bit in a Status Register records a particular type of event, such as an execution error or service request. When an event of a given type occurs, the bit that represents that type of event is set to a value of one. (You can disable bits so that they ignore events and remain at zero; see the Enable Registers section on page 3–131.) Reading the status registers tells you what types of events have occurred.

**The Standard Event Status Register (SESR).** The SESR, (see Figure 3–11 and Table 3–11) records eight types of events that can occur within the HFS 9000. Use the \*ESR? query to read the SESR register. Reading the register clears the bits of the register so that the register can accumulate information about new events.

7	6	5	4	3	2	1	0
PON	URQ	CME	EXE	DDE	QYE	RQC	OPC

**Figure 3–11: The Standard Event Status Register (SESR)**

**Table 3–11: SESR Bit Functions**

Bit	Function
7 (MSB)	<b>PON</b> (Power On). Shows that the HFS 9000 was powered on.
6	<b>URQ</b> (User Request). Shows that the SRQ button was pressed.
5	<b>CME</b> (Command Error). Shows that an error occurred while the HFS 9000 was parsing a command or query. Command error messages are listed in Table 3–14 on page 3–135.
4	<b>EXE</b> (Execution Error). Shows that an error occurred while the HFS 9000 was executing a command or query. Execution error messages are listed in Table 3–15 on page 3–137.
3	<b>DDE</b> (Device Error). Shows that a device error occurred. Device error messages are listed in Table 3–16 on page 3–137.
2	<b>QYE</b> (Query Error). Shows that either an attempt was made to read the Output Queue when no data was present or pending, or that data in the Output Queue was lost.
1	<b>RQC</b> (Request Control). Not used.
0 (LSB)	<b>OPC</b> (Operation Complete). Shows that the operation is complete. This bit is set by the *OPC command.

**The Status Byte Register (SBR).** The SBR (see Figure 3–12 and Table 3–12) records whether output is available in the Output Queue, whether the HFS 9000 requests service, and whether the SESR has recorded any events.

Use a Serial Poll or the \*STB? query to read the contents of the SBR. The bits in the SBR are set and cleared depending on the contents of the SESR, the Event Status Enable Register (ESER), and the Output Queue. (When you use a Serial Poll to obtain the SBR, bit 6 is the RQS bit. When you use the \*STB? query to obtain the SBR, bit 6 is the MSS bit.)

7	6	5	4	3	2	1	0
—	RQS	ESB	MAV	—	—	—	—
	MSS						

**Figure 3–12: The Status Byte Register (SBR)**

Table 3–12: SBR Bit Functions

Bit	Function
7 (MSB)	Not used.
6	<b>RQS</b> (Request Service ) obtained from a serial poll. Shows that the HFS 9000 requests service from the GPIB controller.
6	<b>MSS</b> (Master Status Summary) obtained from *STB? query. Summarizes the ESB and MAV bits in the SBR.
5	<b>ESB</b> (Event Status Bit). Shows that status is enabled and present in the SESR.
4	<b>MAV</b> (Message Available). Shows that output is available in the Output Queue.
3 – 0	Not used.

## Enable Registers

The DESER, ESER, and SRER allow you to select which events are reported to the Status Registers and the Event Queue. Each Enable Register acts as a filter to a Status Register (the DESER also acts as a filter to the Event Queue), and can prevent information from being recorded in the register or queue.

Each bit in an Enable Register corresponds to a bit in the Status Register it controls. In order for an event to be reported to its bit in the Status Register, the corresponding bit in the Enable Register must be set to one. If the bit in the Enable Register is set to zero, the event is not recorded.

The bits in the Enable Registers are set using various commands. The Enable Registers and the commands used to set them are described in the following sections.

**The Device Event Status Enable Register (DESER).** The DESER (see Figure 3–13) controls which types of events are reported to the SESR and the Event Queue. The bits in the DESER correspond to those in the SESR, as described earlier.

Use the DESE command to enable and disable the bits in the DESER. Use the DESE? query to read the DESER.

7	6	5	4	3	2	1	0
PON	URQ	CME	EXE	DDE	QYE	RQC	OPC

Figure 3–13: The Device Event Status Enable Register (DESER)

**The Event Status Enable Register (ESER).** The ESER (see Figure 3–14) controls which types of events are summarized by the Event Status Bit (ESB) in the SBR.

Use the \*ESE command to set the bits in the ESER, and the \*ESE? query to read it.

7	6	5	4	3	2	1	0
PON	URQ	CME	EXE	DDE	QYE	RQC	OPC

**Figure 3-14: The Event Status Enable Register (ESER)**

**The Service Request Enable Register (SRER).** The SRER (see Figure 3-15) controls which bits in the SBR generate a Service Request and are summarized by the Master Status Summary (MSS) bit.

Use the \*SRE command to set the SRER. Use the SRE? query to read it. The RQS bit remains set to one until either the Status Byte Register is read with a Serial Poll or the MSS bit changes back to a zero.

7	6	5	4	3	2	1	0
—	—	ESB	MAV	—	—	—	—

**Figure 3-15: The Service Request Enable Register (SRER)**

**The Enable Registers and the \*PSC Command**

The \*PSC command controls the contents of the Enable Registers at power-on. Sending \*PSC 1 sets the Enable Registers at power-on as follows:

- DESER 255 (equivalent to a DESE 255 command)
- ESER 0 (equivalent to an \*ESE 0 command)
- SRER 0 (equivalent to an \*SRE command)

Sending \*PSC 0 lets the Enable Registers maintain their values in non-volatile memory through a power cycle.

---

**NOTE.** To enable the PON (Power On) event to generate a Service Request, send \*PSC 0, use the DESE and \*ESE commands to enable PON in the DESER and ESER, and use the \*SRE command to enable bit 5 in the SRER. Subsequent power-on cycles will generate a Service Request.

---

## Queues

The HFS 9030 status and event reporting system contains two queues: the Output Queue and the Event Queue.

**The Output Queue** The Output Queue stores up to 1024 bytes of a query response while it is waiting to be output. The Output Queue is emptied each time a new command or query message is received. Any query response must be read before the next command or query is sent or responses to earlier queries will be lost, and an error may result.

**The Event Queue** The Event Queue stores detailed information on up to 20 events. If more than 20 events stack up in the Event Queue, the 20th event is replaced by event code 350, "Too many events."

Read the Event Queue with either the `EVENT?` query (which returns only the event number) or with the `EVMSG?` query (which returns the event number and a text description of the event). Reading an event removes it from the queue.

Before reading an event from the Event Queue, you must use the `*ESR?` query to read the summary of that event from the `SESR`. This makes the events summarized by the `*ESR?` available to the `EVENT?` and `EVMSG?` queries, and empties the `SESR`.

Reading the `SESR` erases any events that were summarized by a previous `*ESR?` but not read from the Event Queue. Events that follow an `*ESR?` are put in the Event Queue but are not available until `*ESR?` is used again.

## Event Handling Sequence

Figure 3–16, on page 3–134, shows how to use the status and event handling system. In the explanation that follows, numbers in parentheses refer to the numbers in circles in Figure 3–16.

When an event occurs, a signal is sent to the `DESER` (1). If that type of event is enabled in the `DESER` (that is, if the bit for that event type is set to 1), the appropriate bit in the `SESR` is set to one and the event is recorded in the Event Queue (2). If the corresponding bit in the `ESER` is also enabled (3), then the `ESB` bit in the `SBR` is set to one (4).

When output is sent to the Output Queue, the `MAV` bit in the `SBR` is set to one (5).

When a bit in the `SBR` is set to one and the corresponding bit in the `SRER` is enabled (6), the `MSS` bit in the `SBR` is set to one and a service request is generated (7).

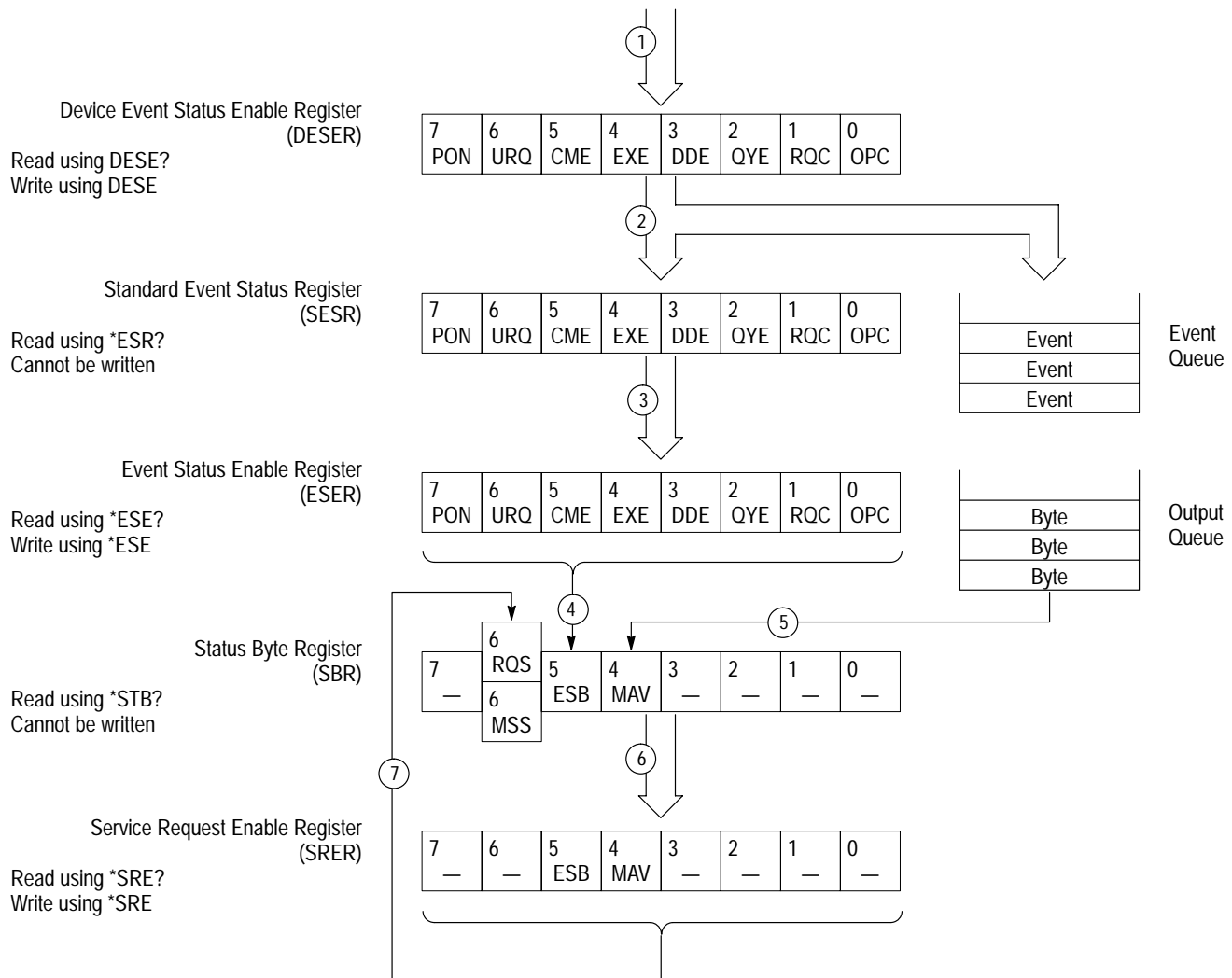

Figure 3-16: Status and Event Handling Process

## Conflicts

Whenever a command is issued resulting in a conflict, an event is generated on the EXE bit (bit 4). This is the equivalent of having blinking menu items when operating the HFS 9000 from the front panel.

You can avoid generating this event if you concatenate commands so that the conflict is resolved when the command is completed. For example, if you set the pulse width longer than the period with a single command, an event is generated. You can then change the period to resolve the conflict. However, if you change the pulse width and then the period in a single concatenated command, no conflict event is generated.

## Messages

Tables 3–13 through 3–18 list all the programming interface messages the HFS 9000 generates in response to commands and queries. For a description of the messages displayed on the front panel, see Appendix D, Error Messages.

For most messages, a secondary message from the HFS 9000 gives more detail about the cause of the error or the meaning of the message. This message is part of the message string and is separated from the main message by a semicolon.

Each message is the result of an event. Each type of event sets a specific bit in the SESR and is controlled by the equivalent bit in the DESER. Thus, each message is associated with a specific SESR bit. In the tables that follow, the associated SESR bit is specified in the table title, with exceptions noted with the error message text.

Table 3–13 shows the messages when the system has no events or status to report. These have no associated SESR bit.

**Table 3–13: No Event Messages**

Code	Message
0	No events to report — queue empty
1	No events to report — new events pending *ESR?

Table 3–14 shows the error messages generated by improper command syntax. Check that the command is properly formatted and that it follows the rules in the Command Syntax chapter starting on page 3–9.

**Table 3–14: Command Error Messages — CME Bit 5**

Code	Message
100	Command error
101	Invalid character
102	Syntax error
103	Invalid message or unit separator
104	Data type error
105	GET not allowed
106	Invalid program data separator
108	Parameter not allowed
109	Missing parameter
110	Command header error



**Table 3-14: Command Error Messages — CME Bit 5 (Cont.)**

<b>Code</b>	<b>Message</b>
111	Header separator error
112	Program mnemonic too long
113	Undefined header
118	Query not allowed
120	Numeric data error
121	Invalid character in number
123	Numeric overflow
124	Too many digits
128	Numeric data not allowed
130	Suffix error
131	Invalid suffix
134	Suffix too long
138	Suffix not allowed
140	Character data error
141	Invalid character data
144	Character data too long
148	Character data not allowed
150	String data error
151	Invalid string data
158	String data not allowed
160	Block data error
161	Invalid block data
168	Block data not allowed
170	Expression error
171	Invalid expression data
178	Expression data not allowed
180	Macro error
181	Invalid outside macro definition
183	Invalid inside macro definition
184	Command in macro requires more/fewer parameters

Table 3–15 lists the execution errors that are detected during execution of a command. In these error messages, you should read “macro” as “alias.”

**Table 3–15: Execution Error Messages — EXE Bit 4**

Code	Message
200	Execution error
212	Trigger not enabled
220	Parameter error
221	Settings in conflict
222	Data out of range
223	Too much data
260	Expression error
261	Math error in expression
262	Expression block unit syntax error
263	Expression block unit execution error
270	Macro error
271	Macro syntax error
272	Macro execution error
273	Illegal macro label
274	Macro parameter error
275	Oversized block in macro definition
276	Macro recursion error
277	Macro redefinition not allowed
278	Macro header not found

Table 3–16 lists the device errors that can occur during operation of the HFS 9000. These errors may indicate that the HFS 9000 needs repair.

**Table 3–16: Device Error Messages — DDE Bit 3**

Code	Message
300	Internal error
310	System error
313	Calibration memory lost
314	Save/recall memory lost

**Table 3–16: Device Error Messages — DDE Bit 3 (Cont.)**

Code	Message
315	Configuration memory lost
350	Too many events (does not set DDE bit)

Table 3–17 lists the system event messages. These messages are generated whenever certain system conditions occur.

**Table 3–17: System Event Messages — QYE Bit 2**

Code	Message
401	Power on – PON Bit 7
402	Operation complete – OPC Bit 0
403	User request – URQ Bit 6
410	Query INTERRUPTED
420	Query UNTERMINATED
430	Query DEADLOCKED
440	Query UNTERMINATED after indefinite response

Table 3–18 lists warning messages that do not interrupt the flow of command execution. These notify you that you may get unexpected results.

**Table 3–18: Execution Warning Messages — EXE Bit 4**

Code	Message
500	Execution warning
510	Value too small, increased to minimum
511	Value too large, decreased to maximum
512	Value rounded to nearest legal setting
513	Level adjusted to new limit
514	This channel's transition time is not variable
515	Settings conflict
540	Phase Lock failed. Set TBAS:PLIN:INPUT ON to reattempt

# Programming Examples

This section contains three example programs that illustrate the methods you can use to control the HFS 9000 from the GPIB interface. These programs are written in GWBASIC. The programs run on a PC compatible system equipped with a Tektronix GURU GPIB card.

## Example 1: Setting Up a Pulse Channel

The first example illustrates the way to send commands to the HFS 9000 to set it to a desired state. The program performs these operations:

- Lines 100 – 140 print the title of the program.
- Lines 150 – 320 are standard GURU card initializations.
- Lines 330 – 370 initialize the HFS 9000.
- Lines 380 – 440 set up the time base.
- Lines 450 – 550 set up two pulse channels.
- Lines 560 – 620 wait for all the above operations to complete. \*OPC? puts a 1 in the output queue when all pending operations are complete. The read in line 620 waits for this 1 to be set.
- Lines 630 – 670 trigger the burst of pulses set up above. IBTRG in line 670 sends GET (Group Execute Trigger), which executes a TBAS:TIN:TRIG command.

This program produces one burst of pulses, unless a trigger signal is continually sent to the HFS 9000 through the **TRIGGER IN** connector. Once the program completes, you can also generate other bursts on demand by pressing the **MANUAL TRIGGER** button.

### Example 1 Listing

```

100 CLS
110 PRINT "HFS 90x0 Precision Pulse Generator"
120 PRINT "Example 1: Setting Up a Pulse Channel"
130 PRINT "(GPIB Version)"
140 PRINT
150 REM
160 REM decl.bas
170 REM
180 REM GURU initialization code; declarations
190 REM
200 CLEAR ,58900!      'IBM BASICA Declarations; =BYTES FREE -size(bib.m)
210 IBINIT1 = 58900!   'a smaller than calculated # is OK in lines 1 & 2
220 IBINIT2 = IBINIT1 +3 'Lines 1 thru 6 MUST be included in your program
230 BLOAD "bib.m",IBINIT1
240 CALL IBINIT1(IBFIND,IBTRG,IBCLR,IBPCT,IBSIC,IBLOC,IBPPC,IBBNA,IBONL,IBRSC,IBSRE,IBRSV,IBPAD,
IBSAD,IBIST,IBDMA,IBEOS,IBTMO,IBEOT,IBRDF,IBWRTF,IBTRAP)
250 CALL IBINIT2(IBGTS,IBCAC,IBWAIT,IBPOKE,IBWRT,IBWRTA,IBCMD,IBCMDA,IBRD,IBRDA,IBSTOP,IBRPP,IBRSP,
IBDIAG,IBXTRC,IBRDI,IBWRTI,IBRDIA,IBWRTIA,IBSTA%,IBERR%,IBCNT%)
300 BDNAME$ = "TEKDEV1"
310 CALL IBFIND (BDNAME$, TEKDEV1%)
320 IF TEKDEV1% < 0 THEN PRINT "IBFIND ERROR":END
330 REM
340 REM Initialize (reset) the pulse generator.
350 REM
360 WRT$ = "*rst;;header on;;verbose on"
370 CALL IBWRT(TEKDEV1%, WRT$)
380 REM
390 REM Set up the time base.
400 REM
410 WRT$ = "fpan:dmenu 'Time Base Menu'"
420 CALL IBWRT(TEKDEV1%, WRT$)
430 WRT$ = "tbas:mode burst;period 1us;count 10;tout:per 5"
440 CALL IBWRT(TEKDEV1%, WRT$)
450 REM
460 REM Set up channels A1 and A2.
470 REM
480 WRT$ = "fpan:dmenu 'Pulse Menu'"
490 CALL IBWRT(TEKDEV1%, WRT$)
500 WRT$ = "pgena:ch1:high 1v;low -1v;ldel 250ns;thold width;width 250ns"
510 CALL IBWRT(TEKDEV1%, WRT$)
520 WRT$ = "pgena:ch2:high 2v;low 0v;ldel 100ns;thold width;width 350ns"
530 CALL IBWRT(TEKDEV1%, WRT$)
540 WRT$ = "pgena:ch1:output on;;pgena:ch2:output on"
550 CALL IBWRT(TEKDEV1%, WRT$)
560 REM
570 REM Wait for above setups to complete.
580 REM
590 WRT$ = "*opc?"
600 CALL IBWRT(TEKDEV1%, WRT$)
610 RD$ = SPACE$(64)
620 CALL IBRD (TEKDEV1%, RD$ )
630 REM
640 REM Trigger the burst of pulses when requested.
650 REM
660 INPUT "Press ENTER to trigger the burst of pulses.",A$
670 CALL IBTRG(TEKDEV1%)
999 END

```

## Example 2: Command/Query Usage with Error Handling

The second example illustrates the use of the status and event system to query the HFS 9000 and to read error messages. The program reads and executes commands or queries that you type on the PC keyboard. If the command you type generates messages or a query response, they are displayed on the PC screen.

- Lines 100 – 140 print the title of the program.
- Lines 150 – 320 are standard GURU card initializations.
- Lines 330 – 370 initialize the HFS 9000.
- Lines 380 – 390 enable event generation. The \*SRE 32 command enables the ESB bit but not the MAV bit.
- Lines 400 – 445 read a command or query from the PC keyboard.
- Lines 450 – 480 send the command or query to the HFS 9000.
- Line 490 calls the event handling subroutine at line 700.
- Line 500 checks whether there was an event, and if not, goes to read the next typed input.
- Lines 510 – 610 check to see if the typed command was a query (the header ends with “?”). If the command was a query, the query response is read. Line 600 checks for EOI on each read of 64 characters; if no EOI is detected, an additional query response is read.

Lines 700 through 980 are the event handling subroutine:

- Line 730 does a serial poll to read the SBR register.
- Lines 740 – 780 check the RQS bit in the SBR register. The RQS bit is set only by the ESB bit because of the \*SRE 32 command on line 380.
- Lines 800 – 980 read the event:
  - Lines 800 – 810 display the value of the SBR register.
  - Lines 820 – 860 read and display the value of the ESR register.
  - Lines 870 – 940 read and display all event messages. At line 910, if val = 0, then the event queue is empty. If the event queue is not empty, the ESR must be read to get the rest of the messages.
  - Lines 970 – 980 report the event to the main program.

### Example 2 Listing

```

100 CLS
110 PRINT "HFS 90x0 Precision Pulse Generator"
120 PRINT "Example 2: Command/Query Usage With Error Handling"
130 PRINT "(GPIB Version)"
140 PRINT
150 REM
160 REM decl.bas
170 REM
180 REM GURU initialization code; declarations
190 REM
200 CLEAR ,58900!      'IBM BASICA Declarations; =BYTES FREE -size(bib.m)
210 IBINIT1 = 58900!   'a smaller than calculated # is OK in lines 1 & 2
220 IBINIT2 = IBINIT1 +3 'Lines 1 thru 6 MUST be included in your program
230 BLOAD "bib.m",IBINIT1
240 CALL IBINIT1(IBFIND,IBTRG,IBCLR,IBPCT,IBSIC,IBLOC,IBPPC,IBBNA,IBONL,IBRSC,IBSRE,IBRSV,IBPAD,
IBSAD,IBIST,IBDMA,IBEOS,IBTMO,IBEOT,IBRDF,IBWRTF,IBTRAP)
250 CALL IBINIT2(IBGTS,IBCAC,IBWAIT,IBPOKE,IBWRT,IBWRTA,IBCMD,IBCMDA,IBRD,IBRDA,IBSTOP,IBRPP,IBRSP,
IBDIAG,IBXTRC,IBRDI,IBWRTI,IBRDIA,IBWRTIA,IBSTA%,IBERR%,IBCNT%)
270 BDNAME$ = "GPIBO"
280 CALL IBFIND (BDNAME$, BRDO%)
290 IF BRDO% < 0 THEN PRINT "IBFIND ERROR":END
300 BDNAME$ = "TEKDEV1"
310 CALL IBFIND (BDNAME$, TEKDEV1%)
320 IF TEKDEV1% < 0 THEN PRINT "IBFIND ERROR":END
330 REM
340 REM Initialize (reset) the pulse generator and enable error generation.
350 REM
360 WRT$ = "*rst;:header on;:verbose on"
370 CALL IBWRT (TEKDEV1%, WRT$)
380 WRT$ = "*cls;:dese 255;*ese 255;*sre 32"
390 CALL IBWRT (TEKDEV1%, WRT$)
400 REM
410 REM Prompt user for a command or query.
420 REM
430 PRINT
440 INPUT "Command/query: ",C$
445 IF (C$ = "quit") OR (C$ = "QUIT") THEN 999
450 REM
460 REM Send command/query to pulse generator and check for errors.
470 REM
480 CALL IBWRT (TEKDEV1%, C$)
490 GOSUB 700
500 IF E% THEN 400
510 REM
520 REM If query, read response from pulse generator.
530 REM
540 IF RIGHT$(C$, 1) <> "?" THEN 400
550 RD$ = SPACE$(64)
560 CALL IBRD (TEKDEV1%, RD$)
570 PRINT
580 PRINT RD$;
590 EOI% = &H2000
600 IF (IBSTA% AND EOI%) <> EOI% THEN 550
610 GOTO 400
700 REM
710 REM Check for errors.
720 REM
730 CALL IBRSP (TEKDEV1%, SPR%)
740 RQS% = &H40 ' Request Service bit

```

```
750 ESB% = &H20 ' Event Status Bit
760 IF (SPR% AND RQS%) = RQS% THEN 800
770 E% = 0
780 RETURN
800 PRINT
810 PRINT "Status Byte: ";SPR%
820 WRT$ = "*esr?"
830 CALL IBWRT (TEKDEV1%, WRT$)
840 RD$ = SPACE$(64)
850 CALL IBRD (TEKDEV1%, RD$)
860 PRINT "ESR Register: ";RD$
870 WRT$ = "evmsg?"
880 CALL IBWRT (TEKDEV1%, WRT$)
890 RD$ = SPACE$(64)
900 CALL IBRD (TEKDEV1%, RD$)
910 IF VAL(MID$(RD$,8)) = 0 THEN 950
920 IF VAL(MID$(RD$,8)) = 1 THEN 820
930 PRINT RD$
940 GOTO 870
970 E% = 1
980 RETURN
999 END
```



## Example 3: Interacting With a User

Example 3 demonstrates using the HFS 9000 in an automated test system, where the front panel is locked out. During automated operation, the testing process may need to pause while you perform some manual setup. You then indicate that the setup is complete by pressing the HFS 9000 **SRQ** button. This program detects the **SRQ** button press and responds by unlocking the front panel and continuing the program.

---

***NOTE.** If you interrupt this program before it completes, the HFS 9000 may be left in local lockout mode, where front panel button presses are ignored. Execute program lines 550 through 570 to restore normal operation.*

---

- Lines 100 – 140 print the title of the program.
- Lines 150 – 320 are standard GURU card initializations.
- Lines 330 – 370 initialize the HFS 9000.
- Lines 380 – 390 enable event generation. The \*SRE 32 command enables the ESB bit but not the MAV bit.
- Lines 400 – 440 lock out the front panel. (The hex 11 value in line 430 is used for the Local Lock Out command.)
- Lines 450 – 460 display a message on the HFS 9000 screen.
- Lines 470 – 520 wait for the HFS 9000 **SRQ** button to be pressed. The SBR register is polled until the RQS bit is set. RQS is set from the URQ bit in the DESER register and the ESB bit in the SBR register.
- Lines 530 – 540 erase the front panel message.
- Line 550 sends a GTL (Go To Local) command to enable the front panel. Local Lock Out is still active after this command is sent.
- Lines 560 – 570 release REN, which clears Local Lock Out.

### Example 3 Listing

```

100 CLS
110 PRINT "HFS 90x0 Precision Pulse Generator"
120 PRINT "Example 3: Interacting With a User"
130 PRINT "(GPIB Version)"
140 PRINT
150 REM
160 REM decl.bas
170 REM
180 REM GURU initialization code; declarations
190 REM
200 CLEAR ,58900! 'IBM BASICA Declarations; =BYTES FREE -size(bib.m)
210 IBINIT1 = 58900! 'a smaller than calculated # is OK in lines 1 & 2
220 IBINIT2 = IBINIT1 +3 'Lines 1 thru 6 MUST be included in your program
230 BLOAD "bib.m",IBINIT1
240 CALL IBINIT1(IBFIND,IBTRG,IBCLR,IBPCT,IBSIC,IBLOC,IBPPC,IBBNA,IBONL,IBRSC,IBSRE,IBRSV,IBPAD,
IBSAD,IBIST,IBDMA,IBEOS,IBTMO,IBEOT,IBRDF,IBWRTF,IBTRAP)
250 CALL IBINIT2(IBGTS,IBCAC,IBWAIT,IBPOKE,IBWRT,IBWRTA,IBCMD,IBCMDA,IBRD,IBRDA,IBSTOP,IBRPP,IBRSP,
IBDIAG,IBXTRC,IBRDI,IBWRTI,IBRDIA,IBWRTIA,IBSTA%,IBERR%,IBCNT%)
270 BDNAMES$ = "GPIB0"
280 CALL IBFIND (BDNAMES$, BRD0%)
290 IF BRD0% < 0 THEN PRINT "IBFIND ERROR":END
300 BDNAMES$ = "TEKDEV1"
310 CALL IBFIND (BDNAMES$, TEKDEV1%)
320 IF TEKDEV1% < 0 THEN PRINT "IBFIND ERROR":END
330 REM
340 REM Initialize (reset) the pulse generator and enable error generation.
350 REM
360 WRT$ = "*rst;:header on;:verbose on"
370 CALL IBWRT (TEKDEV1%, WRT$)
380 WRT$ = "*cls;:dese 255;*ese 255;*sre 32"
390 CALL IBWRT (TEKDEV1%, WRT$)
400 REM
410 REM Lockout the front panel controls
420 REM
430 CMD$ = CHR$(&H11)
440 CALL IBCMD (BRD0%, CMD$)
450 WRT$ = "fpan:message 'The front panel controls are locked out."+CHR$(10)+
"<-- press SRQ to continue.'"
460 CALL IBWRT (TEKDEV1%, WRT$)
470 REM
480 REM Wait for SRQ button to be pressed then unlock front panel controls.
490 REM
500 CALL IBRSP (TEKDEV1%, SPR%)
510 RQS% = &H40 ' ReQuest Service bit
520 IF (SPR% AND RQS%) <> RQS% THEN 500
530 WRT$ = "fpan:message '"
540 CALL IBWRT (TEKDEV1%, WRT$)
550 CALL IBLOC (TEKDEV1%)
560 V% = 0
570 CALL IBSRE (BRD0%, V%)
999 END

```





# Appendix A: Accessories

Some accessories are included with the HFS 9000. If you wish to purchase optional accessories, or purchase additional standard accessories, see a Tektronix products catalog or contact your local Tektronix field representative.

## Standard Accessories

- The *HFS 9000 Stimulus System User Manual* (Tektronix part number 070-8365-01) is this manual.
- **HFS 9003**: Power cord (North American 120 V), Tektronix part number 161-0066-00.
- **HFS 9009**: Power cord (North American 120 V), Tektronix part number 161-0213-00.
- SMA 50  $\Omega$  coaxial cable, 20 inches, Tektronix part number 174-1427-00.
- SMA — BNC Adapter, Tektronix part number 015-0572-00.
- DB-9 to DB-25 cable, Tektronix part number 012-1241-00.
- Zip-lock pouch, Tektronix part number 016-0537-00.
- **HFS 9003**: Type 3AG Fuse, 5 A 250 V, Tektronix part number 159-0014-00.
- **HFS 9003**: Type 3AG Fuse, 4 A 250 V, fast blow, Tektronix part number 159-0017-00.
- **HFS 9009**: Type 3AG Fuse, 15 A 250 V, fast blow, Tektronix part number 159-0256-00.

## Optional Accessories

- Rackmount adapter kit, Tektronix part number 020-1828-00.
- BitWriter™ programming tool and Windows interface for the HFS 9000 Data Time Generator. BitWriter™ includes software and user manual and requires at least a 386 PC, Windows 3.1, and GPIB card.
- The *HFS 9003 Module Service Manual* (Tektronix part number 070-8564-00) gives service information for maintenance and repair of the HFS 9003 to the replaceable module level.

OR

- The *HFS 9009 Module Service Manual* (Tektronix part number 070-8366-01) gives service information for maintenance and repair of the HFS 9009 to the replaceable module level.

## Power Cord Options

- **HFS 9003:** Option A1 universal European 220 V/6 A, 50 Hz, Tektronix part number 161-0066-09.
- **HFS 9003:** Option A2 United Kingdom 240 V/6 A, 50 Hz, Tektronix part number 161-0066-10.
- **HFS 9003:** Option A3 Australian 240 V/6 A, 50 Hz, Tektronix part number 161-0066-11.
- **HFS 9003:** Option A4 North American 250 V/10 A, 60 Hz, Tektronix part number 161-0066-12.
- **HFS 9003:** Option A5 Switzerland 240 V/6 A, 50 Hz, Tektronix part number 161-0154-00.
- **HFS 9009:** Option A1 universal European 220 V/10 A, 50 Hz, Tektronix part number 161-0209-00.
- **HFS 9009:** Option A2 United Kingdom 240 V/10 A, 50 Hz, Tektronix part number 161-0210-00.
- **HFS 9009:** Option A3 Australian 240 V/10 A, 50 Hz, Tektronix part number 161-0211-00.
- **HFS 9009:** Option A4 North American 250 V/10 A, 60 Hz, Tektronix part number 161-0208-00.
- **HFS 9009:** Option A5 Switzerland 240 V/10 A, 50 Hz, Tektronix part number 161-0212-00.

# Appendix B: Specifications

The HFS 9000 family of high-speed logic signal source instruments have a modular architecture with factory-configurable cards. The channels are digitally synthesized from a common clock resulting in highly accurate independent placement of rising and falling edges. The instruments are optimized for digital device characterization with unique triggering capabilities and a variety of pulse outputs. The product family also features low RMS jitter, the ability to compensate for external cable skews, and an easy-to-use graphical human interface.

This section contains the complete specifications for the HFS 9000 Stimulus System and Modules. These specifications are classified as either nominal traits, warranted characteristics, or typical characteristics.

## Nominal Traits

Nominal traits are described using simple statements of fact such as “+2.6 V” for the trait “Maximum high level,” rather than in terms of limits that are performance requirements.

**Table B-1: Nominal Traits — HFS 9PG1 Output Performance**

Each channel and complement driving a 50  $\Omega$  load to ground, except as noted.

Name	Description
Maximum high level	+2.6 V
Minimum low level	-2.00 V
Maximum amplitude	3.00 V
Minimum amplitude	0.50 V
Level resolution	0.01 V
Operation when terminated through 50 $\Omega$ to -2 V	Output levels will be approximately 1 V more negative than the values programmed, specified, and displayed. Actual output levels more negative than -2 V may cause malfunction. Level accuracy specifications do not apply when terminating to -2 V. Both true and complement outputs must be terminated to the same voltage.

**Table B-1: Nominal Traits — HFS 9PG1 Output Performance (Cont.)**

Each channel and complement driving a 50  $\Omega$  load to ground, except as noted.

Name	Description
Operation when terminated to high impedance loads	Output level range will double until certain internal limits are achieved. Since the programmed, specified, and displayed output levels do not match the actual output levels, level accuracy specifications do not apply when terminating to a high impedance load. Because of the larger voltage swings associated with doubled level range, output transition time specifications do not apply when driving a high impedance load.
Output limits	One high limit and one low limit may be enabled or disabled together.

**Table B-2: Nominal Traits — HFS 9PG2 Output Performance**

Each channel and complement driving a 50  $\Omega$  load to ground, except as noted.

Name	Description
Maximum high level	+5.50 V
Minimum low level	-2.00 V
Maximum amplitude	5.50 V
Minimum amplitude	0.50 V
Level resolution	0.01 V
Operation when terminated through 50 $\Omega$ to -2 V	Output levels will be approximately 1 V more negative than the values programmed, specified, and displayed. Actual output levels more negative than -2 V may cause malfunction. Level accuracy specifications do not apply when terminating to -2 V. Both true and complement outputs must be terminated to the same voltage.
Transition time 20% to 80%	Variable from 800 ps to 5 ns
Transition time resolution	10 ps
Output limits	One high limit and one low limit may be enabled or disabled together.



**Table B-3: Nominal Traits — HFS 9DG1 Output Performance**

Each channel and complement driving a 50  $\Omega$  load to ground, except as noted.

Name	Description
Maximum high level	+5.0 V
Minimum low level	-2.5 V
Maximum amplitude	3.00 V
Minimum amplitude	0.01 V
Level resolution	0.01 V
Operation when terminated through 50 $\Omega$ to -2 V	Output levels will be approximately 1 V more negative than the values programmed, specified, and displayed. Actual output levels more negative than -2 V may cause malfunction. Level accuracy specifications do not apply when terminating to -2 V. Both true and complement outputs must be terminated to the same voltage.
Operation when terminated to high impedance loads	Output level range will double until certain internal limits are achieved. Since the programmed, specified, and displayed output levels do not match the actual output levels, level accuracy specifications do not apply when terminating to a high impedance load. Because of the larger voltage swings associated with doubled level range, output transition time specifications do not apply when driving a high impedance load.
Output limits	One high limit and one low limit may be enabled or disabled together.

**Table B-4: Nominal Traits — HFS 9DG2 Output Performance**

Each channel and complement driving a 50  $\Omega$  load to ground, except as noted.

Name	Description
Maximum high level	+5.50 V
Minimum low level	-2.00 V
Maximum amplitude	5.50 V
Minimum amplitude	0.01 V
Level resolution	0.01 V
Operation when terminated through 50 $\Omega$ to -2 V	Output levels will be approximately 1 V more negative than the values programmed, specified, and displayed. Actual output levels more negative than -2 V may cause malfunction. Level accuracy specifications do not apply when terminating to -2 V. Both true and complement outputs must be terminated to the same voltage.
Transition time 20% to 80%	Variable from 800 ps to 6 ns

**Table B-4: Nominal Traits — HFS 9DG2 Output Performance (Cont.)**

Each channel and complement driving a 50 Ω load to ground, except as noted.

Name	Description
Transition time resolution	10 ps
Output limits	One high limit and one low limit may be enabled or disabled together.

**Table B-5: Nominal Traits — Time Base**

Name	Description
Frequency range	HFS 9PG1, HFS 9DG1: 50 kHz to 630 MHz HFS 9PG2, HFS 9DG2: 50 kHz to 300 MHz <sup>1</sup>
Frequency resolution	≤ 0.1% of frequency setting
Minimum frequency setting when using half, quarter, or eighth pulse rate modes <sup>2</sup>	half pulse rate: 100 kHz quarter pulse rate: 200 kHz eighth pulse rate: 400 kHz
Number of pulse periods in burst or auto-burst modes	User selectable from 1 to 65,536

<sup>1</sup> If the HFS 9PG2 or HFS 9DG2 is operated in half pulse rate mode, frequency can be extended to 600 MHz for the HFS 9PG2 and 630 MHz for the HFS 9DG2.

<sup>2</sup> All pulse rate modes result in 50 kHz output frequency.

**Table B-6: Nominal Traits — Performance to External Frequency Reference**

Name	Description
<b>PHASE LOCK IN</b> input characteristic	0.1 μF DC blocking capacitor followed by 50 Ω termination to ground
Phase lock output frequency range	Any 2 <sup>n</sup> multiple or sub-multiple of the phase lock frequency that is within the allowed frequency range for the card being used
<b>FRAME SYNC IN</b>	Initiates a burst when using phase lock mode
<b>FRAME SYNC IN</b> input characteristic	50 Ω terminated to -2 V

**Table B-7: Nominal Traits — Output Edge Placement Performance<sup>1</sup>**

Name	Description
Channel deskew ( <b>Chan Delay</b> ) range, channels relative to time zero reference	-60 ns to 2.0 $\mu$ s
Channel deskew ( <b>Chan Delay</b> ) resolution	HFS 9PG1, HFS 9PG2: 5 ps HFS 9DG1, HFS 9DG2: 1 ps
Delay ( <b>Lead Delay</b> ) adjustment range	Zero to 20 $\mu$ s
Delay ( <b>Lead Delay, Trail Delay</b> ) adjustment resolution	HFS 9PG1, HFS 9PG2: 5 ps HFS 9DG1, HFS 9DG2: 1 ps
Pulse width adjustment range	HFS 9PG1, HFS 9PG2: Zero to (one period - 790 ps) inclusive HFS 9DG1, HFS 9DG2: Zero to (one period $\times$ 65,536) inclusive
Pulse width adjustment resolution	HFS 9PG1, HFS 9PG2: 5 ps HFS 9DG1, HFS 9DG2: 1 ps
Fine knob resolution of timing	5 ps

<sup>1</sup> Measured at 50% levels, each channel independent.

**Table B-8: Nominal Traits — Transducer In Performance**

Name	Description
<b>TRANSDUCER IN</b> input characteristic	HFS 9PG1: 1000 pF DC blocking capacitor followed by 50 $\Omega$ termination to ground HFS 9PG2: 100 pF DC blocking capacitor followed by 50 $\Omega$ termination to ground

**Table B-9: Nominal Traits — Skew Cal In Performance**

Name	Description
<b>SKEW CAL IN</b> usage	Calibration use only. No signal, except from a channel <b>OUTPUT</b> connector during the calibration process, should ever be applied to this input.

**Table B-10: Nominal Traits — Trigger In Performance**

Name	Description
Input Voltage range	±5 V maximum
Trigger level range	±4.70 V
Trigger level resolution	100 mV

**Table B-11: Nominal Traits — Trigger Out Performance**

Name	Description
Pretrigger range, TRIGGER OUT before time zero reference	Zero to 70 ns
TRIGGER OUT pulse width in auto mode	<p>The graph plots pulse width in nanoseconds (ns) on a logarithmic y-axis (0.1 to 100) against output frequency in MHz on a logarithmic x-axis (0.01 to 1000). The pulse width is constant at approximately 20 ns for frequencies from 0.01 MHz to 10 MHz. Above 10 MHz, the pulse width drops sharply to about 1 ns and exhibits a sawtooth-like oscillation between 1 ns and 2 ns up to 1000 MHz.</p>

**Table B-12: Nominal Traits — Power Requirements**

Name	HFS 9003 Description	HFS 9009 Description
Fuse ratings	5 A, 250 V, type 3AG, (Tektronix part 159-0014-00), and 4 A, 250 V, type 3AG, fast blow, (Tektronix part 159-0017-00)	15 A, 250 V, type 3AG, fast blow, (Tektronix part 159-0256-00)

**Table B-13: Nominal Traits — System Memory Performance**

Name	Description
Non-volatile memory retention time	Instrument settings and calibration constants are retained in non-volatile memory for 5 years or more. Card identification is retained for 10 years. Extended storage above 50° C may degrade the life of all non-volatile memory.

**Table B-14: Nominal Traits — HFS 9003 Mechanical**

Name	Description
Weight, in 12-channel configuration. (Shipping weight includes all standard accessories.)	Cabinet
	Rackmount
Net weight:	45 lbs. (20.5 kg)
	51 lbs. (23.2 kg)
Shipping weight:	60 lbs. (27.3 kg)
	66 lbs. (30.0 kg)
Overall Dimensions	Cabinet
	Rackmount
	Width: 16.3 in. (414 mm)
	19.0 in. (483 mm)
	Height: 7.0 in. (178 mm)
7.0 in. (178 mm)	
Depth: 24.75 in. (629 mm)	
24.75 in. (629 mm)	
Depth behind rack flange:	—
22.0 in. (559 mm)	
Cooling Method	Forced-air circulation with no air filter, maximum 318 cfm
Construction Material	Chassis parts are constructed of aluminum alloy; bezel is glass-filled polycarbonate with Lexan plastic inserts; cabinet is aluminum with textured epoxy paint.

**Table B-15: Nominal Traits — HFS 9009 Mechanical**

Name	Description
Weight, in 36-channel configuration. (Shipping weight includes all standard accessories.)	Rackmount
	Net weight: 81 lbs. (33.7 kg)
Shipping weight:	100 lbs. (45.3 kg)
Overall Dimensions	Rackmount
	Width: 16.75 in. (425.79 mm)
	Height: 14.00 in. (355.89 mm)
	Depth: 24.00 in. (610.11 mm)
Cooling Method, mainframe	Forced-air circulation with air filter, maximum 318 cfm
Cooling Method, power supply	Forced-air circulation, maximum 106 cfm
Construction Material	Chassis parts are constructed of aluminum alloy with Lexan plastic inserts; cabinet is aluminum with textured epoxy paint.

## Warranted Characteristics

Warranted characteristics are described in terms of quantifiable performance limits which are warranted. Names of characteristics that appear in boldface type have checks for verifying the specifications in the *Check Procedures* section.

**Table B-16: Warranted Characteristics — HFS 9PG1 Output Performance**

Name	Description
<b>High level accuracy (amplitude <math>\geq 1</math> V or high level <math>\geq 0</math> V)<sup>1</sup></b>	$\pm 2\%$ of level, $\pm 50$ mV
<b>Low level accuracy (amplitude <math>\geq 1</math> V or high level <math>\geq 0</math> V)<sup>1</sup></b>	$\pm 2\%$ of high level, $\pm 2\%$ of amplitude, $\pm 50$ mV
<b>Transition time 20% to 80% (amplitude <math>\leq 1</math> V)</b>	$\leq 200$ ps

<sup>1</sup> If amplitude  $< 1$  V and high level  $< 0$  V, accuracy typically meets the specification but is not guaranteed

**Table B-17: Warranted Characteristics — HFS 9PG2 Output Performance**

Name	Description
<b>High level accuracy</b>	$\pm 2\%$ of level, $\pm 50$ mV
<b>Low level accuracy</b>	$\pm 2\%$ of high level, $\pm 2\%$ of amplitude, $\pm 50$ mV
<b>Transition time accuracy 20% to 80% (amplitude <math>\leq 1</math> V)</b>	$\pm 10\%$ of setting, $\pm 300$ ps

**Table B-18: Warranted Characteristics — HFS 9DG1 Output Performance**

Name	Description
<b>High level accuracy (amplitude <math>\geq 0.5</math> V)<sup>1</sup></b>	$\pm 2\%$ of level, $\pm 50$ mV
<b>Low level accuracy (amplitude <math>\geq 0.5</math> V)<sup>1</sup></b>	$\pm 2\%$ of high level, $\pm 2\%$ of amplitude, $\pm 50$ mV
<b>Transition time 20% to 80% (amplitude <math>\leq 1</math> V)</b>	$\leq 250$ ps

<sup>1</sup> If amplitude  $< 0.5$  V, accuracy typically meets the specification but is not guaranteed

Table B-19: Warranted Characteristics — HFS 9DG2 Output Performance

Name	Description
High level accuracy (amplitude $\geq 0.5$ V) <sup>1</sup>	$\pm 2\%$ of level, $\pm 50$ mV
Low level accuracy (amplitude $\geq 0.5$ V) <sup>1</sup>	$\pm 2\%$ of high level, $\pm 2\%$ of amplitude, $\pm 50$ mV
Transition time accuracy 20% to 80% (amplitude $\leq 1$ V)	$\pm 10\%$ of setting, $\pm 300$ ps

<sup>1</sup> If amplitude  $< 0.5$  V, accuracy typically meets the specification but is not guaranteed.

Table B-20: Warranted Characteristics — Time Base

Name	Description
Frequency accuracy	$\pm 1\%$

Table B-21: Warranted Characteristic — Performance to External Frequency Reference

Name	Description
PHASE LOCK IN frequency range	6 MHz to 630 MHz

Table B-22: Warranted Characteristics — Output Edge Placement Performance<sup>1</sup>

Name	Description
Delay of pulses relative to time zero reference (Lead Delay) accuracy	HFS 9PG1, HFS 9PG2: 1% of (Lead Delay + Chan Delay) $\pm 300$ ps HFS 9DG1, HFS 9DG2: 1% of (Lead Delay + Chan Delay) $\pm 50$ ps
Pulse width accuracy	HFS 9PG1: 1% of width $\pm 300$ ps HFS 9PG2: 1% of width $\pm 300$ ps [for widths $\geq 20$ ns]; 1% of width + 300 ps, -500 ps [for widths $< 20$ ns] HFS 9DG1: 1% of width + 50 -75 ps HFS 9DG2: 1% of width + 50 ps, -250 ps [for widths $\geq 20$ ns]; 1% of width + 50 ps, -450 ps [for widths $< 20$ ns]

<sup>1</sup> Measured at 50% levels, each channel independent.

**Table B-23: Warranted Characteristics — Trigger Out Performance**

Name	Description
TRIGGER OUT signal levels	Amplitude $\geq 300$ mV ( $-0.5$ V $\geq$ offset $\geq -1.5$ V, driving $50 \Omega$ to ground)

**Table B-24: Warranted Characteristics — Power Requirements**

Name	Description
Primary circuit dielectric break-down voltage	1500 VAC <sub>RMS</sub> , 60 Hz for 10 seconds without breakdown
Primary Grounding	0.1 $\Omega$ maximum from chassis ground and protective earth ground

**Table B-25: Warranted Characteristics — Environmental and Safety**

Name	HFS 9003 Description	HFS 9009 Description
Temperature	Operating: 0° C to +50° C (32° F to 122° F) Non-operating (storage): -40° C to +75° C (-40° F to 167° F)	Operating: 0° C to +40° C (32° F to 104° F) Non-operating (storage): -40° C to +75° C (-40° F to 167° F)
Altitude	Operating: 4 hours at 3,048 m (10,000 feet). Derate maximum operating temperature by -1° C (-1.8° F) for each 304.8 m (1,000 feet) above 1,524 m (5,000 feet) Non-operating: 2 hours at 12,192 m (40,000 feet)	
Humidity	Operating: < 95% RH, non-condensing, from 0° C to 30° C (32° F to 86° F) < 75% RH, non-condensing, from 31° C to 40° C (88° F to 104° F) (MIL-T-28800E, para 4.5.5.1.2.2, Type III, Class 5)	
Shock (non-operating)	MIL-T-28800E, para 4.5.5.4.1, Type III, Class 5	
Resistance to mishandling during bench use (operating)	MIL-T-28800E, para 4.5.5.4.3, Type III, Class 5	
Resistance to packaged transportation vibration, sinusoidal, in shipping package	Drops of 36 inches on all edges, faces, and corners National Safe Transit Association, test procedure 1A-B-2	
Resistance to packaged transportation vibration, sinusoidal, in shipping package	Packaged sinusoidal vibration National Safe Transit Association, test procedure 1A-B-1	
Resistance to packaged transportation random vibration	MIL-STD-810D, method 514.3, category I, Figure 514.3-1	



**Table B-25: Warranted Characteristics — Environmental and Safety (Cont.)**

Name	HFS 9003 Description	HFS 9009 Description
Safety	Listed to UL1244 Certified to CAN/CSA-C22.2 No. 231-M89	
IEC Specifications	Installation Category II Pollution Degree 2 Safety Class I	

## Typical Characteristics

Typical characteristics are described in terms of typical or average performance. Typical characteristics are not warranted.

**Table B-26: Typical Characteristics — Time Base**

Name	Description
RMS jitter	15 ps, $\pm 0.05\%$ of interval
Recovery time between bursts or auto-bursts	15 $\mu$ s

**Table B-27: Typical Characteristics — HFS 9PG1 Output Performance**

Name	Description
Transition time 20% to 80%	Amplitude $\leq 1$ V: 150 ps 1 V < Amplitude $\leq 2$ V: 190 ps 2 V < Amplitude $\leq 3$ V: 225 ps
Output aberrations (beginning 200 ps after 50% point of transition)	Overshoot: +15%, +20 mV Undershoot: -10%, -20 mV

**Table B–28: Typical Characteristics — HFS 9PG2 Output Performance**

Name	Description
Operation when terminated to high impedance loads	Output level range will double until certain internal limits are achieved. Since the programmed, specified, and displayed output levels do not match the actual output levels, level accuracy specifications do not apply when terminating to a high impedance load. Because of the larger voltage swings associated with doubled level range, output transition time specifications do not apply when driving a high impedance load.
Transition time accuracy 20% to 80%	±10% of setting, ±300 ps
Output aberrations	Overshoot: +15%, +20 mV Undershoot: -10%, -20 mV

**Table B–29: Typical Characteristics — HFS 9DG1 Output Performance**

Name	Description
Transition time 20% to 80%	Amplitude ≤ 1 V: ≤ 250 ps, 250 ps 1 V < Amplitude < 2 V: 250 ps 2 V ≤ Amplitude ≤ 3 V: 260 ps
Output aberrations	Overshoot: +15%, +20 mV Undershoot: -10%, -20 mV

**Table B–30: Typical Characteristics — HFS 9DG2 Output Performance**

Name	Description
Operation when terminated to high impedance loads	Output level range will double until certain internal limits are achieved. Since the programmed, specified, and displayed output levels do not match the actual output levels, level accuracy specifications do not apply when terminating to a high impedance load. Because of the larger voltage swings associated with doubled level range, output transition time specifications do not apply when driving a high impedance load.
Transition time accuracy 20% to 80%	±10% of setting, ±300 ps
Output aberrations	Overshoot: +15%, +20 mV Undershoot: -10%, -20 mV

**Table B-31: Typical Characteristics — Performance to External Frequency Reference**

Name	Description
<b>PHASE LOCK IN</b> amplitude range	0.8 V to 1.0 V peak-to-peak
<b>PHASE LOCK IN</b> transition time requirement	20% to 80% in $\leq 10$ ns
<b>FRAME SYNC IN</b> signal level	$-1.810 \text{ V} \leq V_{\text{low}} \leq -1.475 \text{ V}$ $-1.165 \text{ V} \leq V_{\text{high}} \leq -0.810 \text{ V}$ (standard 100 K ECL levels)
Setup time, rising edge of <b>FRAME SYNC IN</b> signal to rising edge of <b>PHASE LOCK IN</b>	650 ps minimum
Hold time, high level of <b>FRAME SYNC IN</b> after rising edge of <b>PHASE LOCK IN</b>	650 ps minimum
Time from frame sync qualified phase lock clock cycle to time-zero reference	70 ns minimum, 130 ns

**Table B-32: Typical Characteristics — Transducer In Performance**

Name	Description
<b>TRANSDUCER IN</b> useful frequency range	HFS 9PG1: 25 MHz to > 1 GHz HFS 9PG2: 5 MHz to 300 MHz
<b>TRANSDUCER IN</b> amplitude requirement	1.0 V to 1.5 V peak-to-peak

**Table B-33: Typical Characteristics — Trigger In Performance**

Name	Description
Input resistance	50 $\Omega$
Trigger level accuracy	$\pm 100$ mV $\pm 5\%$ of trigger level
Trigger input rise/fall time requirement	$\leq 10$ ns
Minimum trigger input pulse width	1 ns
Trigger sensitivity	$\leq 500$ mV
Time from trigger in to time-zero reference	70 ns minimum, 130 ns typical

**Table B-34: Typical Characteristics — Trigger Out Performance**

Name	Description
Pretrigger resolution	250 ps

**Table B-35: Typical Characteristics — Power Requirements**

Name	HFS 9003 Description	HFS 9009 Description
Line Voltage	90 VAC <sub>RMS</sub> to 130 VAC <sub>RMS</sub> or 180 VAC <sub>RMS</sub> to 250 VAC <sub>RMS</sub> , range switched automatically	90 VAC <sub>RMS</sub> to 104 VAC <sub>RMS</sub> with maximum 7 cards installed, 104 VAC <sub>RMS</sub> to 132 VAC <sub>RMS</sub> with maximum 9 cards installed, or 180 VAC <sub>RMS</sub> to 250 VAC <sub>RMS</sub> , range switched automatically
Line frequency	48 Hz to 63 Hz	
Power consumption	540 W maximum	1190 W with maximum of 9 cards installed
Inrush surge current	50 A maximum up to 40 ms at 110 VAC 100 A maximum up to 40 ms at 220 VAC	

# Appendix C: Interface Specifications

This appendix describes details of the remote interfaces of the Stimulus System, both the serial port (RS-232-C) and GPIB. Normally, you will not need this information to use the HFS 9000, but the information is useful when connecting to controllers of unusual configuration.

This appendix also contains general information that pertains to programming with both interfaces including a chart of the ASCII character set and a list of reserved words.

## Interface Messages

Table C-1 shows the standard interface messages that are supported by the HFS 9000.

**Table C-1: HFS 9000 Standard Interface Messages**

Message	GPIB	RS-232-C
DCL	Yes	Yes (provided by Break)
GET	Yes	Yes (provided by *TRG)
GTL	Yes	No
LLO	Yes	No
PPC	No	No
PPD	No	No
PPE	No	No
PPU	No	No
SDC	Yes	No
SPD	Yes	No
SPE	Yes	No
UNL	Yes	No
UNT	Yes	No
Listen Addresses	Yes	No
Talk Addresses	Yes	No

## Character Set (ASCII Chart)

Table C–2 shows the character set used for all messages to and from the HFS 9000. This is identical to standard ASCII.

Table C–2: The ASCII Character Set

	0	1	2	3	4	5	6	7
0	NUL 0	DLE 16	space 32	0 48	@ 64	P 80	' 96	p 112
1	SOH 1	DC1 17	! 33	1 49	A 65	Q 81	a 97	q 113
2	STX 2	DC2 18	" 34	2 50	B 66	R 82	b 98	r 114
3	ETX 3	DC3 19	# 35	3 51	C 67	S 83	c 99	s 115
4	EOT 4	DC4 20	\$ 36	4 52	D 68	T 84	d 100	t 116
5	ENQ 5	NAK 21	% 37	5 53	E 69	U 85	e 101	u 117
6	ACK 6	SYN 22	& 38	6 54	F 70	V 86	f 102	v 118
7	BEL 7	ETB 23	' 39	7 55	G 71	W 87	g 103	w 119
8	BS 8	CAN 24	( 40	8 56	H 72	X 88	h 104	x 120
9	HT 9	EM 25	) 41	9 57	I 73	Y 89	i 105	y 121
A	LF 10	SUB 26	* 42	: 58	J 74	Z 90	j 106	z 122
B	VT 11	ESC 27	+ 43	; 59	K 75	[ 91	k 107	{ 123
C	FF 12	FS 28	, 44	< 60	L 76	\ 92	l 108	 124
D	CR 13	GS 29	- 45	= 61	M 77	] 93	m 109	} 125
E	SO 14	RS 30	. 46	> 62	N 78	^ 94	n 110	~ 126
F	SI 15	US 31	/ 47	? 63	O 79	_ 95	o 111	rubout 127

## Reserved Words

The following is a list of the reserved words of the HFS 9000. You cannot use these words as names of aliases.

ABUR	CONSTA	DSETTI	LDELA	ON	PRETR
ABURS	CONSTAN	DSETTIN	LDELAY	ONE	PRETRI
ABURST	CONSTANT	DSETTING	LEV	OUTP	PRETRIG
ALI	COUN	ECHO	LEVE	OUTPUT	PRETRIGG
ALIA	COUNT	EOL	LEVEL	OUTPUT	PRETRIGGE
ALIAS	COUT	EVEN	LF	PAR	PRETRIGGER
ALL	COUTP	EVENT	LFCR	PARI	PURGE
AMPL	COUTPU	EVMSG	LHOL	PARIT	PVI
AMPLI	COUTPUT	FACTORY	LHOLD	PARITY	PVIE
AMPLIT	CR	FINE	LIM	PER	PVIEW
AMPLITU	CRLF	FLAG	LIMI	PERI	RS232
AMPLITUD	DCH	FLAGG	LIMIT	PERIO	SBIT
AMPLITUDE	DCHA	FLAGGI	LLIM	PERIOD	SBITS
AUTO	DCHAN	FLAGGIN	LLIMI	PGENA	SLOP
BAUD	DCHANN	FLAGGING	LLIMIT	PGENB	SLOPE
BURS	DCHANNE	FPAN	LOW	PGENC	SOFT
BURST	DCHANNEL	FREQ	LVI	PGEND	TBAS
CAL	DCYC	FREQU	LVIE	PGENE	TDEL
CAT	DCYCL	FREQUE	LVIEW	PGENF	TDELA
CATA	DCYCLE	FREQUEN	MAX	PGENG	TDELAY
CATAL	DEF	FREQUENC	MESS	PGENH	THOL
CATALO	DEFI	FREQUENCY	MESSA	PGENI	THOLD
CATALOG	DEFIN	HALF	MESSAG	PGENJ	TIN
CDEL	DEFINE	HARD	MESSAGE	PGENK	TINP
CDELA	DEL	HEADER	MIN	PHAS	TINPU
CDELAY	DELA	HIGH	MODE	PHASE	TINPUT
CH1	DELAY	HLIM	NAME	PLIN	TOUT
CH2	DELE	HLIMI	NEG	POL	TRAN
CH3	DELET	HLIMIT	NEGA	POLA	TRANS
CH4	DELETE	INP	NEGAT	POLAR	TRANSI
CID	DESE	INPU	NEGATI	POLARI	TRANSIT
COAR	DISP	INPUT	NEGATIV	POLARIT	TRANSITI
COARS	DISPL	KEY	NEGATIVE	POLARITY	TRANSITIO
COARSE	DISPLA	KRES	NONE	POS	TRANSITION
COMP	DISPLA	KRESO	NORM	POSI	TRIG
COMPL	DISPLAY	KRESOL	NORMA	POSIT	TRIGG
COMPLE	DIT	KRESOLU	NORMAL	POSITI	TRIGGE
COMPLEM	DITE	KRESOLUT	ODD	POSITIV	TRIGGER
COMPLEME	DITEM	KRESOLUTI	OFF	POSITIVE	VERBOSE
COMPLEMEN	DMEN	KRESOLUTIO	OFFS	PRAT	WIDT
COMPLEMENT	DMENU	KRESOLUTION	OFFSE	PRATE	WIDTH
CONS	DSET	LDEL	OFFSET	PRET	ZERO
CONST	DSETT				

## Using Debug Mode

You can turn on **Debug** from either the GPIB or RS-232 menu. The purpose of debug mode is to let you observe command operation as commands are sent to the HFS 9000. Debug is especially useful when you are trying to debug a program and you have the controller set to single-step through the commands.

When debug mode is on, the debug window (see Figure C-1) is displayed above the menu. This window is present regardless of which menu is displayed.

```

REM LLO ATN LADS TADS RS232 Error >XOFF XOFF>
<DCL>factory<EOI>*cls<EOI>tbas:mode burst;cou
nt 100;*trg<EOI>tbas:mode auto<EOI><GET>EVENT
(212)dese 255;*ese 255;*sre 32<EOI><SRQ>^J

```

Figure C-1: The Debug Window

The bottom three rows of the debug window show the most recent commands received by the HFS 9000, regardless of which interface received them (GPIB or RS-232). The row of the debug window shows several indicators which appear only when appropriate. The indicators and their meanings are:

- **REM**. The HFS 9000 is in the remote state. Generally, remote means that the HFS 9000 expects to receive commands through the GPIB. If local lockout is enabled with remote, the front panel is rendered inactive (except for the **SRQ** button and the pulse generator channel buttons), and the **REMOTE** light on the front panel is lit. If local lockout has not been enabled, then front-panel commands will be entered and executed regardless of the remote or local state. When you de-assert the remote enable line, local lockout is reset automatically. Refer to the documentation on your controller to determine how you control the remote enable line.
- **LLO**. The HFS 9000 is in local lockout mode. The front panel is inactive when both the LLO command is received and REM (remote enable) is asserted. Use the LLO command to assert local lockout mode. Once local lockout mode is asserted, you can reset it by de-asserting remote enable.
- **ATN**. The attention line is asserted (low) on the GPIB. This means that the controller is sending an interface command on the bus. When not asserted, the data I/O lines are carrying data.
- **LADS**. The HFS 9000 is addressed on the GPIB to listen.
- **TADS**. The HFS 9000 is addressed on the GPIB to talk.
- **RS232 Error**. An error has occurred during I/O on the RS-232-C interface. Check the RS-232-C settings, especially **Baud Rate**, **Parity**, and **Stop Bits**. This error flag can also occur when the input buffer has overflowed, which



may indicate the controller failing to acknowledge that the HFS 9000 has flagged busy by sending an XOff character. See XOff> below.

You can clear the RS232 Error flag by turning Debug off and then on.

- >XOff. An XOff character has been received by the HFS 9000 on the RS-232-C controller. The HFS 9000 has responded by suspending output. When the HFS 9000 receives an XOn character, output will resume.
- XOff>. The HFS 9000 has sent an XOff character to the RS-232-C controller because the HFS 9000 input buffer is nearly full. The controller should acknowledge the XOff character by not sending any more characters until the HFS 9000 sends an XOn character. If the controller fails to respond to the HFS 9000 XOff request within three characters, the RS232 Error flag may turn on to indicate possible loss of data.

## GPIB Function Subsets

The HFS 9000 supports many GPIB function subsets, as listed below. Some of the listings describe subsets that the HFS 9000 does not support.

- SH1 (Source Handshake). The HFS 9000 can transmit multi-line messages across the GPIB.
- AH1 (Acceptor Handshake). The HFS 9000 can receive multi-line messages across the GPIB.
- T6 (Talker). The HFS 9000 becomes a talker when its talk address is sent with the ATN (Attention) line asserted. It ceases to be a talker when another device's talk address is sent with ATN asserted. The HFS 9000 has no talk-only capability.
- L4 (Listener). The HFS 9000 becomes a listener when its listen address is sent with the ATN (Attention) line asserted. The HFS 9000 does not have listen-only capability.
- SR1 (Service Request). The HFS 9000 asserts an SRQ (Service Request) line to notify the controller when it requires service.
- RL1 (Remote/Local). The HFS 9000 responds to both the GTL (Go To Local) and LLO (Local Lock Out) interface messages.
- PPO (Parallel Poll). The HFS 9000 has no parallel poll capability. It does not respond to the following interface messages: PPC, PPD, PPE, and PPU. The HFS 9000 does not send out a status message when the ATN (Attention) and EOI (End of Instruction) lines are asserted simultaneously.

- DCL (Device Clear). When acting as a listener, the HFS 9000 responds to the DCL (Device Clear) and SDC (Selected Device Clear) interface messages.
- DT1 (Device Trigger). The HFS 9000 responds to the GET (Group Execute Trigger) interface message.
- C0 (Controller). The HFS 9000 cannot control other devices.
- E2 (Electrical). The HFS 9000 uses tri-state buffers to provide optimal high-speed data transfer.

## Wiring for Alternate RS-232-C Configurations

The RS-232-C cable included with the HFS 9000 connects the HFS 9000 to a standard RS-232-C serial port with a DB-25 female connector configured as DCE (Data Communications Equipment). If your controller is configured differently, you will need to obtain or build a different cable or adapter. The information below will assist a qualified service person to identify or build the necessary custom cable.

### Serial Port DB-9 Pin Assignments

The HFS 9000 serial port is a 9-pin male connector with the following pin assignments listed in Table C-3. This port configuration is equivalent to the Compaq personal computer 9-pin serial port.

**Table C-3: Serial Port DB-9 Pin Assignments**

Pin	RS-232-C Signal Name
1	DCD — Carrier Detect
2	RXD — Receive Data
3	TXD — Transmit Data
4	DTR — Data Terminal Ready
5	Signal Ground
6	DSR — Data Set Ready
7	RTS — Request To Send
8	CTS — Clear To Send
9	RNG — Ring Indicator

### Standard Accessory Serial Cable

The standard accessory serial cable supplied with the HFS 9000, Tektronix part number 012-1241-00, connects the HFS 9000 to a standard RS-232-C serial port with a DB-25 female connector configured as DCE (Data Communications Equipment).

In effect, the standard accessory serial cable converts the HFS 9000 to a standard RS-232-C serial port with a DB-25 male connector configured as DTE (Data Terminal Equipment).

Table C-4 shows the wiring of the standard accessory cable. This table also shows the standard cable's effective pin assignments at the DB-25 connector when the DB-9 connector is attached to the HFS 9000.

**Table C-4: Standard Accessory Cable Connections**

DB-9 Female 9-Pin Connector Pin Number	DB-25 Male 25-Pin Connector Pin Number	RS-232-C Pin Assignments when Cable Connected to HFS 9000
1	8	DCD — Carrier Detect
2	3	RXD — Receive Data
3	2	TXD — Transmit Data
4	20	DTR — Data Terminal Ready
5	7	Signal Ground
6	6	DSR — Data Set Ready
7	4	RTS — Request To Send
8	5	CTS — Clear To Send
9	22	RNG — Ring Indicator

### Connection to IBM PC DB-25 Ports

The easiest way to connect to an IBM PC or PC clone is to create a “null modem” or converter. This connects to the IBM PC serial port, and the standard accessory cable connects to the null modem. The converter is non-polarized; it can be connected either way between the standard accessory cable and the IBM PC serial port. The wiring for the null modem is shown in Table C-5.

**Table C-5: Converter Wiring for 25-pin PCs**

DB-25 Female 25-Pin Connector Pin Number	DB-25 Female 25-Pin Connector Pin Number
1	1
2	3
3	2
4	8
5 and 6	20
8	4
20	5 and 6

**Connection to IBM PC  
DB-9 Ports**

To connect the HFS 9000 to an IBM PC or compatible having DB-9 (9-pin) serial ports, do not use the standard accessory cable at all. Instead, obtain a DB-9 to DB-9 cable with the wiring shown in Table C-6. Either end of this cable may be connected to either the HFS 9000 or the IBM PC.

**Table C-6: Converter Cable for 9-pin PCs<sup>1</sup>**

DB-9 Female 9-Pin Connector Pin Number	DB-9 Female 9-Pin Connector Pin Number
1	7
2	3
3	2
4	6 and 8
5	5
6 and 8	4
7	1

<sup>1</sup> Neither connector uses pin 9.

# Appendix D: Error Messages

Table D–1 shows all the error messages that can be displayed on the screen of the HFS 9000. Included are explanations of the cause of each message and how to correct it.

**Table D–1: Displayed Error Messages**

Message	Explanation
Calibration failed	The HFS 9000 has failed to calibrate itself to its internal voltage and timing references. It needs repair.
Calibration memory is corrupted	Calibration memory has lost all information. To reset it, perform a total instrument reset as described under Reset in the User Reference section of this manual.
Invalid character in number	You have entered a number through the numeric keypad that contains an improper character. Re-enter the number.
Level adjusted to new limit. Press Undo to restore it.	The level you entered is outside the established limits. You need not do anything; the level has been set to the nearest limit. If you want to restore the previous level, press <b>UNDO</b> .
Numeric data error	You have entered an improper number through the numeric keypad. Re-enter the number.
Out of memory	The HFS 9000 has run out of internal memory.
Phase Lock failed. Turn on PhaseLockIn to reattempt.	The HFS 9000 cannot phase lock on the signal connected to the <b>PHASE LOCK IN</b> connector. Make certain the signal is stable, continuous, and within the amplitude and frequency range specified. The HFS 9000 will also fail to phase lock if the instrument needs calibrating. Retry by turning on the <b>PhaseLockIn</b> menu item again.
Press Select to modify the highlighted item	The highlighted menu item cannot be adjusted using the knob or numeric keypad.
Press Select to modify the highlighted view	Use the <b>SELECT</b> button to change the menu item to a different name for the same parameter (for example, to change <b>Frequency</b> to <b>Period</b> ). The knob or keypad cannot be used to do this.
Press Select to perform the highlighted action	The knob or keypad cannot be used to initiate the action selected in the highlighted menu item.
Press Select to show the highlighted menu	When the main menu is displayed, only the <b>SELECT</b> button can display the highlighted menu. The knob or keypad cannot be used.
Stored setting memory is corrupted	The memory holding the stored settings has lost the settings. Perform a <b>Factory</b> reset to clear all stored settings and clean up the settings memory.

Table D-1: Displayed Error Messages (Cont.)

Message	Explanation
That card's identifier memory is corrupted	The memory holding the card identifier string has lost its information. This string cannot be established from the front panel. Use a GPIB or RS-232-C device to execute the <code>CAL:CID</code> command and re-establish the card identifier string.
The displayed menu does not select channels	The <b>PREVIOUS CHANNEL</b> and <b>NEXT CHANNEL</b> buttons do not work with the displayed menu.
There is no stored setting by that number	There is no stored setting in the storage cell you have specified to recall settings from. Select a different storage cell that has a box around it indicating that it is not empty.
There is nothing to undo	There is no previous operation to be undone.  <i><b>NOTE.</b> Whenever you change menu display, the queue of previous operations is emptied. If you press the UNDO button immediately after changing menu display, you will see this error message.</i>
This channel's transition time is not variable	You cannot adjust the transition time of High Speed pulse generator channels. The requested adjustment has been ignored.
Time Base failed to stop	Your HFS 9000 needs repair.
To use manual trigger, set Time Base mode to "Burst"	Manual triggering cannot be used in Auto or Auto-Burst time base modes. Set the mode item in the Time Base menu to Burst.
Use the Knob or Keypad to modify the highlighted item	The highlighted menu item cannot be adjusted using the <b>SELECT</b> button.
Value rounded to a legal setting	The value you entered was not an exact value to which a parameter can be set. You need not do anything; it has been set to the nearest value that is acceptable.
Value too large, decreased to maximum	The maximum value for a parameter is smaller than the value you entered. You need not do anything; the value has been adjusted to the maximum allowable value.
Value too small, increased to minimum	The minimum value for a parameter is larger than the value you entered. You need not do anything; the value has been adjusted to the minimum allowable value.

## Appendix E: Packing for Shipment

If you ship the HFS 9000, pack it in the original shipping carton and packing material. If the original packing material is not available, package the instrument as follows:

1. Use a corrugated cardboard shipping carton with inside dimensions of at least 15 cm (6 in) taller, wider, and deeper than the HFS 9000. The shipping carton must be constructed of cardboard with 375 pound test strength.
2. If you are shipping the HFS 9000 to a Tektronix field office for repair, attach a tag to the HFS 9000 showing the instrument owner and address, the name of the person to contact about the instrument, the instrument type, and the serial number.
3. Wrap the HFS 9000 with polyethelene sheeting or equivalent material to protect the finish.
4. Cushion the HFS 9000 in the shipping carton by tightly packing dunnage or urethane foam on all sides between the carton and the HFS 9000. Allow 7.5 cm (3 in) on all sides, top, and bottom.
5. Seal the shipping carton with shipping tape or an industrial stapler.





# Appendix F: Performance Verification

The following tests verify that the HFS 9000 Stimulus System achieves its specified performance.

## Required Test Equipment

Refer to Table F–1 for a list of the test equipment required to verify performance.

**Table F–1: Required Test Equipment**

Item Number and Description	Minimum Requirements	Example	Purpose
1 Digital Volt Meter	DC volt accuracy: $\pm 0.1\%$ from 0.40 V to 5.5 V	Tektronix DM 511	Output level and amplitude checks
2 BNC female to dual banana plug	—	Tektronix part number 103-0090-00	Output level and amplitude checks
3 Cable, Precision Coaxial, BNC	36-inch, 50 $\Omega$	Tektronix part number 012-0482-00	Output level and amplitude checks
4 Precision Feed-through Terminator	50 $\Omega$ , 0.1% at DC	Tektronix part number 011-0129-00	Output level and amplitude checks
5 Digital Sampling Oscilloscope	$\Delta$ time accuracy: $\pm (0.25\% + 10 \text{ ps})$ from 100 ps to 1 $\mu\text{s}$ Freq. Measurement accuracy: $\pm 0.10\%$ from 50 kHz to 630 MHz	Tektronix 11801B Digital Sampling Oscilloscope or CSA803A Communication Signal Analyzer	Trigger Output Check, Rise and fall time checks, Edge placement checks, Frequency accuracy check
6 Sampling Head	Rise time: $\leq 60 \text{ ps}$ (10% to 90%)	Tektronix SD-22, SD-24, or SD-26	Used with Tektronix Digital Sampling Oscilloscope (item 5)
7 Attenuator, 5X, SMA	50 $\Omega$ , $\geq 12 \text{ GHz}$ bandwidth	Tektronix part number 015-1002-00	Rise and fall time checks
8 Cable, Coaxial, SMA (two required)	20-inch, 50 $\Omega$	Tektronix part number 174-1427-00	Trigger Output Check, Rise and fall time checks, Edge placement check, Frequency accuracy check
9 Generator, Leveled Sine Wave	Capable of producing 0.8 V <sub>p-p</sub> amplitude up to 600 MHz into 50 $\Omega$	Tektronix SG 504	Phase lock check

**Table F-1: Required Test Equipment (Cont.)**

Item Number and Description	Minimum Requirements	Example	Purpose
10 BNC female to SMA male adapter	—	Tektronix part number 015-1018-00	Output level and amplitude checks, Phase lock check
11 Threaded SMA female to SMA male slip-on connector	—	Tektronix part number 015-0553-00	SMA quick disconnect

## Test Record

Identify the type of cards you will be testing and photocopy the appropriate tables from pages F-3 to F-9. Use these tables to record the performance test results for the instrument.

**Table F-2: Trigger Output Level and Phase Lock Test**

Instrument Serial Number: _____		Page _____ of _____		Certificate Number: _____	
Temperature: _____		RH %: _____		Technician: _____	
Date of Calibration: _____					
Performance Test		Minimum	Incoming	Outgoing	Maximum
<b>Trigger Output Level</b> Amplitude $\geq 300$ mV ( $-0.5$ V $\geq$ offset $\geq -1.5$ V, driving $50 \Omega$ to ground)					
Output	Maximum High Level	N/A	_____	_____	$\leq -0.5$ V
	Minimum Low Level	$\geq -1.5$ V	_____	_____	N/A
	Minimum Amplitude	$\geq 300$ mV <sub>p-p</sub>	_____	_____	N/A
<b>Phase Lock Test</b> 1% (frequency set accuracy of generator)					
Output	0.8 V, 250 MHz	250 MHz	247.5	_____	252.5
Channel	0.8 V, 594 MHz	594 MHz	588.1	_____	599.9

**Table F-3: Test Record for HFS 9DG1 Card**

Channel: _____	Page _____ of _____
Instrument Serial Number: _____	Certificate Number: _____
Temperature: _____	RH %: _____
Date of Calibration: _____	Technician: _____

Performance Test		Nominal	Minimum	Incoming	Outgoing	Maximum
<b>Output</b> High Level: $\pm 2\%$ of level, $\pm 50$ mV    Low Level: $\pm 2\%$ of High Level, $\pm 2\%$ of amplitude (p-p), $\pm 50$ mV						
Output Channel	Complement	+5.0 V	+4.850	_____	_____	+5.150
	Normal	+2.0 V	1.790	_____	_____	+2.210
	Normal	-2.5 V	-2.680	_____	_____	-2.320
	Complement	-1.5 V	-1.580	_____	_____	-1.420
Not Output Channel	Normal	+5.0 V	+4.850	_____	_____	+5.150
	Complement	+2.0 V	1.790	_____	_____	+2.210
	Complement	-2.5 V	-2.680	_____	_____	-2.320
	Normal	-1.5 V	-1.580	_____	_____	-1.420
<b>Rise Time / Fall Time</b> $\leq 250$ ps for Amplitude $\leq 1$ V						
Output Channel	Normal, 1V, Tr	250 ps	N/A	_____	_____	250 ps
	Complement, 1 V, Tf	250 ps	N/A	_____	_____	250 ps
Not Output Channel	Normal, 1V, Tf	250 ps	N/A	_____	_____	250 ps
	Complement, 1 V, Tr	250 ps	N/A	_____	_____	250 ps
<b>Edge Placement Pulse Delay Time</b> 1% of (Lead Delay + Chan Delay) $\pm 50$ ps						
Output Channel	Normal	100 ps	49	_____	_____	151
		500 ps	445	_____	_____	555
		1 ns	0.940	_____	_____	1.060
		5 ns	4.900	_____	_____	5.100
		10 ns	9.850	_____	_____	10.150
		50 ns	49.45	_____	_____	50.55
		100 ns	98.95	_____	_____	101.05
Not Output Channel	Normal	100 ps	49	_____	_____	151
		500 ps	445	_____	_____	555
		1 ns	0.940	_____	_____	1.060
		5 ns	4.900	_____	_____	5.100
		10 ns	9.850	_____	_____	10.150
		50 ns	49.45	_____	_____	50.55
		100 ns	98.95	_____	_____	101.05
<b>Edge Placement Pulse Width Variance</b> 1% of width $\pm 50$ ps						
Output Channel	Normal	500 ps	445	_____	_____	555
		750 ps	693	_____	_____	808
		1 ns	0.940	_____	_____	1.060
Not Output Channel	Normal	500 ps	445	_____	_____	555
		750 ps	693	_____	_____	808
		1 ns	0.940	_____	_____	1.060

**Table F-3: Test Record for HFS 9DG1 Card (Cont.)**

Channel: \_\_\_\_\_ Page \_\_\_\_\_ of \_\_\_\_\_  
 Instrument Serial Number: \_\_\_\_\_ Certificate Number: \_\_\_\_\_  
 Temperature: \_\_\_\_\_ RH %: \_\_\_\_\_  
 Date of Calibration: \_\_\_\_\_ Technician: \_\_\_\_\_

Performance Test	Nominal	Minimum	Incoming	Outgoing	Maximum
<b>Pulse Width Limits</b> 1% of width +50 -75ps					
Output Channel Normal	5 ns	4.875	_____	_____	5.100
	10 ns	9.825	_____	_____	10.150
	50 ns	49.425	_____	_____	50.55
	100 ns	98.925	_____	_____	101.05
	500 ns	494.925	_____	_____	505.05
	1 µs	0.990	_____	_____	1.010
Not Output Channel Normal	5 ns	4.875	_____	_____	5.100
	10 ns	9.825	_____	_____	10.150
	50 ns	49.425	_____	_____	50.55
	100 ns	98.925	_____	_____	101.05
	500 ns	494.925	_____	_____	505.05
	1 µs	0.990	_____	_____	1.010
<b>Frequency Accuracy</b> ± 1%					
Output Channel	50 kHz	49.50	_____	_____	50.50
	324 MHz	320.8	_____	_____	327.2
	326 MHz	322.7	_____	_____	329.3
	400 MHz	396.0	_____	_____	404.0
	433 MHz	428.7	_____	_____	437.3
	466 MHz	461.3	_____	_____	470.7
	500 MHz	495.0	_____	_____	505.0
	533 MHz	527.7	_____	_____	538.3
	566 MHz	560.3	_____	_____	571.7
	600 MHz	594.0	_____	_____	606.0
630 MHz	623.7	_____	_____	636.3	

**Table F-4: Test Record for HFS 9DG2 Card**

Channel: _____	Page _____ of _____
Instrument Serial Number: _____	Certificate Number: _____
Temperature: _____	RH %: _____
Date of Calibration: _____	Technician: _____

Performance Test	Nominal	Minimum	Incoming	Outgoing	Maximum	
<b>Output</b> High Level: $\pm 2\%$ of level, $\pm 50$ mV    Low Level: $\pm 2\%$ of High Level, $\pm 2\%$ of amplitude (p-p), $\pm 50$ mV						
Output Channel	Complement	+5.5 V	+5.340	_____	_____	+5.660
	Normal	0.0 V	-0.270	_____	_____	+0.270
	Normal	-2.0 V	-2.090	_____	_____	-1.910
	Complement	-1.0 V	-1.070	_____	_____	-0.930
<b>Rise Time / Fall Time</b> $\pm 10\%$ of setting $\pm 300$ ps for Amplitude $\leq 1$ V						
Output Channel	Normal, 1V, Tr	0.8 ns	0.420	_____	_____	1.180
	Complement, 1 V, Tf	0.8 ns	0.420	_____	_____	1.180
	Normal, 1 V, Tr	5 ns	4.200	_____	_____	5.800
	Complement, 1 V, Tf	5 ns	4.200	_____	_____	5.800
<b>Edge Placement Pulse Delay Time</b> 1% of (Lead Delay + Chan Delay) $\pm 50$ ps						
Output Channel	Normal	100 ps	49	_____	_____	151
		500 ps	445	_____	_____	555
		1 ns	0.940	_____	_____	1.060
		5 ns	4.900	_____	_____	5.100
		10 ns	9.850	_____	_____	10.150
		50 ns	49.45	_____	_____	50.55
		100 ns	98.95	_____	_____	101.05
<b>Edge Placement Pulse Width Limits</b> (1% + 50 ps, -450 ps) for widths $< 20$ ns    (1% + 50 ps, -250 ps) for widths $\geq 20$ ns						
Output Channel		5 ns	4.500	_____	_____	5.100
		10 ns	9.450	_____	_____	10.150
		50 ns	49.25	_____	_____	50.55
		100 ns	98.75	_____	_____	101.05
		500 ns	494.8	_____	_____	505.1
		1 $\mu$ s	0.990	_____	_____	1.010
<b>Frequency Accuracy</b> $\pm 1\%$						
Output Channel		50 kHz	49.50	_____	_____	50.50
		162 MHz	160.4	_____	_____	163.6
		163 MHz	161.4	_____	_____	164.6
		200 MHz	198.0	_____	_____	202.0
		216.5 MHz	214.3	_____	_____	218.7
		233 MHz	230.7	_____	_____	235.3
		250 MHz	247.5	_____	_____	252.5
		266.5 MHz	263.8	_____	_____	269.2
		283 MHz	280.2	_____	_____	285.8
		300 MHz	297.0	_____	_____	303.0

Table F-5: Test Record for HFS 9PG1 Card

Channel: _____		Page _____ of _____				
Instrument Serial Number: _____		Certificate Number: _____				
Temperature: _____		RH %: _____				
Date of Calibration: _____		Technician: _____				
Performance Test		Nominal	Minimum	Incoming	Outgoing	Maximum
<b>Output</b> High Level: $\pm 2\%$ of level, $\pm 50$ mV		Low Level: $\pm 2\%$ of High Level, $\pm 2\%$ of amplitude (p-p), $\pm 50$ mV				
Output Channel	Complement	+2.6 V	+2.498	_____	_____	+2.702
	Normal	-0.4 V	-0.562	_____	_____	-0.238
	Normal	-2 V	-2.090	_____	_____	-1.910
	Complement	-1 V	-1.070	_____	_____	-0.930
Not Output Channel	Normal	+2.6 V	+2.498	_____	_____	+2.702
	Complement	-0.4 V	-0.562	_____	_____	-0.238
	Complement	-2 V	-2.090	_____	_____	-1.910
	Normal	-1 V	-1.070	_____	_____	-0.930
<b>Rise Time / Fall Time <math>\leq 200</math> ps for Amplitude <math>\leq 1</math> V</b>						
Output Channel	Normal, 1V, Tr	200 ps	N/A	_____	_____	200 ps
	Complement, 1 V, Tf	200 ps	N/A	_____	_____	200 ps
Not Output Channel	Normal, 1V, Tf	200 ps	N/A	_____	_____	200 ps
	Complement, 1 V, Tr	200 ps	N/A	_____	_____	200 ps
<b>Edge Placement Pulse Delay Time 1% of (Lead Delay + Chan Delay) <math>\pm 300</math> ps</b>						
Output Channel	Normal	100 ps	-201	_____	_____	401
		500 ps	195	_____	_____	805
		1 ns	0.690	_____	_____	1.310
		5 ns	4.650	_____	_____	5.350
		10 ns	9.600	_____	_____	10.400
		50 ns	49.20	_____	_____	50.80
		100 ns	98.70	_____	_____	101.30
Not Output Channel	Normal	100 ps	-201	_____	_____	401
		500 ps	195	_____	_____	805
		1 ns	0.690	_____	_____	1.310
		5 ns	4.650	_____	_____	5.350
		10 ns	9.600	_____	_____	10.400
		50 ns	49.20	_____	_____	50.80
		100 ns	98.70	_____	_____	101.30
<b>Edge Placement Pulse Width Variance 1% of width <math>\pm 300</math> ps</b>						
Output Channel	Normal	500 ps	195	_____	_____	805
		750 ps	443	_____	_____	1060
		1 ns	0.690	_____	_____	1.310
Not Output Channel	Normal	500 ps	195	_____	_____	805
		750 ps	443	_____	_____	1058
		1 ns	0.690	_____	_____	1.310

**Table F-5: Test Record for HFS 9PG1 Card (Cont.)**

Channel: _____	Page _____ of _____
Instrument Serial Number: _____	Certificate Number: _____
Temperature: _____	RH %: _____
Date of Calibration: _____	Technician: _____

Performance Test	Nominal	Minimum	Incoming	Outgoing	Maximum
<b>Pulse Width Limits 1% of width <math>\pm</math> 300 ps</b>					
Output Channel Normal	5 ns	4.650	_____	_____	5.350
	10 ns	9.600	_____	_____	10.400
	50 ns	49.20	_____	_____	50.80
	100 ns	98.70	_____	_____	101.30
	500 ns	494.70	_____	_____	505.30
	1 $\mu$ s	0.990	_____	_____	1.010
Not Output Channel Normal	5 ns	4.650	_____	_____	5.350
	10 ns	9.600	_____	_____	10.400
	50 ns	49.20	_____	_____	50.80
	100 ns	98.70	_____	_____	101.30
	500 ns	494.70	_____	_____	505.30
	1 $\mu$ s	0.990	_____	_____	1.010
<b>Frequency Accuracy <math>\pm</math> 1%</b>					
Output Channel	50 kHz	49.50	_____	_____	50.50
	324 MHz	320.8	_____	_____	327.2
	326 MHz	322.7	_____	_____	329.3
	400 MHz	396.0	_____	_____	404.0
	433 MHz	428.7	_____	_____	437.3
	466 MHz	461.3	_____	_____	470.7
	500 MHz	495.0	_____	_____	505.0
	533 MHz	527.7	_____	_____	538.3
	566 MHz	560.3	_____	_____	571.7
	600 MHz	594.0	_____	_____	606.0
630 MHz	623.7	_____	_____	636.3	



Table F-6: Test Record for HFS 9PG2 Card

Channel: _____		Page _____ of _____				
Instrument Serial Number: _____		Certificate Number: _____				
Temperature: _____		RH %: _____				
Date of Calibration: _____		Technician: _____				
Performance Test		Nominal	Minimum	Incoming	Outgoing	Maximum
<b>Output</b> High Level: $\pm 2\%$ of level, $\pm 50$ mV		Low Level: $\pm 2\%$ of High Level, $\pm 2\%$ of amplitude (p-p), $\pm 50$ mV				
Output Channel	Complement	+5.5 V	+5.340	_____	_____	+5.660
	Normal	0 V	-0.270	_____	_____	+0.270
	Normal	-2 V	-2.090	_____	_____	-1.910
	Complement	-1 V	-1.070	_____	_____	-0.930
Not Output Channel	Normal	+5.5 V	+5.340	_____	_____	+5.660
	Complement	0 V	-0.270	_____	_____	+0.270
	Complement	-2 V	-2.090	_____	_____	-1.910
	Normal	-1 V	-1.070	_____	_____	-0.930
<b>Rise Time / Fall Time</b> $\pm 10\%$ of setting $\pm 300$ ps for Amplitude $\leq 1$ V						
Output Channel	Normal, 1V, Tr	0.8 ns	0.420	_____	_____	1.180
	Complement, 1 V, Tf	0.8 ns	0.420	_____	_____	1.180
	Normal, 1 V, Tr	5 ns	4.200	_____	_____	5.800
	Complement, 1 V, Tf	5 ns	4.200	_____	_____	5.800
Not Output Channel	Normal, 1V, Tf	0.8 ns	0.420	_____	_____	1.180
	Complement, 1 V, Tr	0.8 ns	0.420	_____	_____	1.180
	Normal, 1 V, Tf	5 ns	4.200	_____	_____	5.800
	Complement, 1 V, Tr	5 ns	4.200	_____	_____	5.800
<b>Edge Placement Pulse Delay Time</b> 1% of (Lead Delay + Chan Delay) $\pm 300$ ps						
Output Channel	Normal	100 ps	-201	_____	_____	401
		500 ps	195	_____	_____	805
		1 ns	0.690	_____	_____	1.310
		5 ns	4.650	_____	_____	5.350
		10 ns	9.600	_____	_____	10.400
		50 ns	49.20	_____	_____	50.80
		100 ns	98.70	_____	_____	101.30
Not Output Channel	Normal	100 ps	-201	_____	_____	401
		500 ps	195	_____	_____	805
		1 ns	0.690	_____	_____	1.310
		5 ns	4.650	_____	_____	5.350
		10 ns	9.600	_____	_____	10.400
		50 ns	49.20	_____	_____	50.80
		100 ns	98.70	_____	_____	101.30

**Table F-6: Test Record for HFS 9PG2 Card (Cont.)**

Channel: _____		Page _____ of _____				
Instrument Serial Number: _____		Certificate Number: _____				
Temperature: _____		RH %: _____				
Date of Calibration: _____		Technician: _____				
Performance Test		Nominal	Minimum	Incoming	Outgoing	Maximum
<b>Edge Placement Pulse Width Limits</b> (1% of width + 300 ps, -500 ps) for widths < 20 ns (1% of width, ± 300 ps) for widths > 20 ns						
Output Channel	Normal	5 ns	4.450	_____	_____	5.350
		10 ns	9.400	_____	_____	10.400
		50 ns	49.20	_____	_____	50.80
		100 ns	98.70	_____	_____	101.30
		500 ns	494.7	_____	_____	505.3
		1 μs	0.990	_____	_____	1.010
Not Output Channel	Normal	5 ns	4.450	_____	_____	5.350
		10 ns	9.400	_____	_____	10.400
		50 ns	49.20	_____	_____	50.80
		100 ns	98.70	_____	_____	101.30
		500 ns	494.7	_____	_____	505.3
		1 μs	0.990	_____	_____	1.010
<b>Frequency Accuracy ± 1%</b>						
Output Channel	Nominal = HFS Setting Output = Nominal/2	100 kHz	49.50	_____	_____	50.50
		324 MHz	160.4	_____	_____	163.6
		326 MHz	161.4	_____	_____	164.6
		400 MHz	198.0	_____	_____	202.0
		433 MHz	214.3	_____	_____	218.7
		466 MHz	230.7	_____	_____	235.3
		500 MHz	247.5	_____	_____	252.5
		533 MHz	263.8	_____	_____	269.2
		566 MHz	280.2	_____	_____	285.8
600 MHz	297.0	_____	_____	303.0		

## Verification Sequence

The performance verification procedure consists of the following steps, performed in the following order:

1. Perform the HFS 9000 internal self test that follows this list of steps. If the self test indicates problems, refer to the *Maintenance* section in the Service Manual to repair the instrument.
2. Perform the internal calibration on page F-12 if the HFS 9000 has not been recalibrated within the last six months, or if the HFS 9000 has been reconfigured with different cards or has been adjusted or repaired.
3. Follow the procedures in the Check Procedures section beginning on page F-13 to verify that the HFS 9000 performs to every specification.

### Self Test

The HFS 9000 is equipped with self-test diagnostic routines that execute automatically when you switch the power on. You may also manually select the diagnostic routines.

Use the following procedure to manually select the diagnostic routines:

1. Press **MAIN MENU** and select **Cal/Deskew Menu**.
2. Select **Self Test**.

The HFS 9000 display indicates the circuits under test as it proceeds through the diagnostics. The HFS 9000 returns to normal operating mode after successfully completing the diagnostics.

If the HFS 9000 detects a failure, it suspends normal operation and displays an error code (see the *Maintenance* section in the Service Manual for further information). The display presents two choices:

- Press any button other than the **SELECT** button to show a terse description of the failure. This additional information may assist you in isolating a failure to a module, or to determine if users can continue to operate the HFS 9000. The next diagnostic test will not begin until you press the **SELECT** button.
- Press the **SELECT** button to continue with the next diagnostic test.

A self-test failure does not necessarily indicate that the HFS 9000 is inoperable. However, it does indicate that the instrument is out of specification and that it might not be fully operational.

**Calibration** The calibration procedure adjusts the instrument to its internal voltage and timing references and saves the settings in non-volatile memory.

Calibrate the HFS 9000 at least every six months. The instrument does not need more frequent calibration unless it is reconfigured or used in an ambient temperature that differs by more than 5° C from the temperature it was last calibrated in.

---

***NOTE.** Run the calibration procedure only when the HFS 9000 has been powered on for 20 minutes in the temperature environment you expect it to be used in.*

---

To calibrate the HFS 9000, select the **Calibrate** item in the Cal/Deskew menu.

After you select the Calibrate item, verify this choice in the subsequent dialog box. After verification, the HFS 9000 starts the Timebase calibration and prompts you to attach an SMA cable from the front panel SKEW CAL IN connector to the TRIGGER OUT connector. The HFS 9000 then prompts you to connect each channel OUTPUT connector in turn. The HFS 9000 performs the calibration automatically during the time that each channel is connected. The time for the calibration procedure varies by configuration.

A 20 inch, 50  $\Omega$  coaxial SMA cable (Tektronix part number 174-1427-00) is supplied with the HFS 9000 as a standard accessory. This cable is suitable for use during calibration.

## Check Procedures

Once you have run the self-test procedure, and, if necessary, calibrated the HFS 9000, these check procedures will verify that the instrument performs as specified.

### Instrument Setup

Select **MAIN MENU** and reset the HFS 9000 using the **Reset** item in the Save/Recall menu. After this reset, the parameters listed below are properly set for all tests and need not be modified again. However, each check specifies a reset as a first step to ensure the following settings:

- Cal/Deskew menu, **Pretrigger** item: 70 ns
- Cal/Deskew menu, **Channel Delay** item: 0 s (all channels)
- Time Base menu, **Mode** item: Auto
- Levels menu, **Limit** item: Off
- Pulse menu, **Signal Type** item: Pulse

---

***NOTE.** Allow the HFS 9000 to warm up for a minimum of 20 minutes. The instrument must warm up in an ambient temperature within 5° C of the ambient temperature when last calibrated.*

---

After you have set up the first channel for a particular check, use the **Copy Channel** and **Paste Channel** menu items to transfer the setup to the other channels.

### Output Level Checks (HFS 9DG1 Card Only)

These tests check the output level in volts DC of each data generator channel. You will need to repeat these checks for each output channel; the number of times you repeat a check depends on the configuration of your HFS 9000. A reference to “the channel” is a reference to the particular channel being checked.

<b>Equipment Required</b>	One DVM (digital voltmeter, item 1) One BNC female to dual banana connector (item 2) One precision coaxial cable (item 3) One feedthrough termination (item 4) One threaded SMA female to SMA male slip-on connector (item 11).
---------------------------	---

1. Reset the HFS 9000.
2. Set the Digital Voltmeter to measure DC volts on Auto Range.

3. Construct the termination assembly by connecting the following items in the order listed:
  - a. one BNC female to dual banana connector (item 2)
  - b. one precision coaxial cable (item 3)
  - c. one feedthrough termination (item 4)
  - d. one BNC female to SMA male adapter (item 10)
  - e. one threaded SMA female to SMA male slip-on connector (item 11).
4. Connect the banana plug end of the termination assembly to the input of the DVM and connect the other end to the channel normal **OUTPUT** connector.
5. Set the HFS 9000 according to Table F-7.

**Table F-7: HFS 9DG1 Output Level Checks, First Settings**

Control	Setting
Pulse menu, <b>Channel</b>	The channel under test
Pulse menu, <b>Output</b>	On
Pulse menu, <b>~Output</b>	Off
Pulse menu, <b>Pulse Rate</b>	Off
Pulse menu, <b>Polarity</b>	Complement
Pulse menu, <b>High Level</b>	5.0 V
Pulse menu, <b>Low Level</b>	2.0 V

The output voltage reading on the DVM should be between 4.850 V and 5.150 V.

6. Change the Pulse menu **Polarity** item setting to **Normal**.

The output voltage reading on the DVM should be between 1.790 V and 2.210 V.

7. Set the HFS 9000 according to Table F-8.

**Table F-8: HFS 9DG1 Output Level Checks, Second Settings**

Control	Setting
Pulse menu, <b>High Level</b>	-1.5 V
Pulse menu, <b>Low Level</b>	-2.5 V

The output voltage reading on the DVM should be between  $-2.680\text{ V}$  and  $-2.320\text{ V}$ .

8. Change the Pulse menu **Polarity** item setting to **Complement**.

The output voltage reading on the DVM should be between  $-1.580\text{ V}$  and  $-1.420\text{ V}$ .

9. Move the feedthrough termination assembly to the channel complemented OUTPUT. The DVM is now set to monitor the complement output.

10. Set the HFS 9000 according to Table F-9.

**Table F-9: HFS 9DG1 Output Level Checks, Third Settings**

Control	Setting
Pulse menu, <b>Output</b>	Off
Pulse menu, <b>~Output</b>	On
Pulse menu, <b>Polarity</b>	Normal
Pulse menu, <b>High Level</b>	5.0 V
Pulse menu, <b>Low Level</b>	2.0 V

The output voltage reading on the DVM should be between  $4.850\text{ V}$  and  $5.150\text{ V}$ .

11. Change the Pulse menu **Polarity** item setting to **Complement**.

The output voltage reading on the DVM should be between  $1.790\text{ V}$  and  $2.210\text{ V}$ .

12. Set the HFS 9000 according to Table F-10.

**Table F-10: HFS 9DG1 Output Level Checks, Fourth Settings**

Control	Setting
Pulse menu, <b>High Level</b>	$-1.5\text{ V}$
Pulse menu, <b>Low Level</b>	$-2.5\text{ V}$

The output voltage reading on the DVM should be between  $-2.680\text{ V}$  and  $-2.320\text{ V}$ .

13. Change the Pulse menu **Polarity** item setting to **Normal**.

The output voltage reading on the DVM should be between  $-1.580\text{ V}$  and  $-1.420\text{ V}$ .

14. Repeat steps 1 through 13 for each of the HFS 9DG1 channels in the system.

15. Disconnect test setup.

**Output Level Checks  
(HFS 9DG2 and HFS 9PG2  
Cards Only)**

These tests check the output level in volts DC of each pulse or data generator channel. You will need to repeat these checks for each output channel; the number of times you repeat a check depends on the configuration of your HFS 9000. A reference to “the channel” is a reference to the particular channel being checked.

<b>Equipment Required</b>	One DVM (digital voltmeter, item 1) One BNC female to dual banana connector (item 2) One precision coaxial cable (item 3) One feedthrough termination (item 4) One threaded SMA female to SMA male slip-on connector (item 11).
---------------------------	---

1. Reset the HFS 9000.
2. Set the Digital Voltmeter to measure DC volts on Auto Range.
3. Construct the termination assembly by connecting the following items in the order listed:
  - a. one BNC female to dual banana connector (item 2)
  - b. one precision coaxial cable (item 3)
  - c. one feedthrough termination (item 4)
  - d. one BNC female to SMA male adapter (item 10)
  - e. one threaded SMA female to SMA male slip-on connector (item 11).
4. Connect the banana plug end of the termination assembly to the input of the DVM and connect the other end to the channel normal **OUTPUT** connector.
5. Set the HFS 9000 according to Table F–11.



Table F-11: HFS 9DG2 and HFS 9PG2 Output Level Checks, First Settings

Control	Setting
Pulse menu, <b>Channel</b>	The channel under test
Pulse menu, <b>Output</b>	On
Pulse menu, <b>~Output</b>	Off
Pulse menu, <b>Pulse Rate</b>	Off
Pulse menu, <b>Polarity</b>	Complement
Pulse menu, <b>High Level</b>	5.5 V
Pulse menu, <b>Low Level</b>	0 V

The output voltage reading on the DVM should be between 5.340 V and 5.660 V.

6. Change the Pulse menu **Polarity** item setting to **Normal**.

The output voltage reading on the DVM should be between  $-0.270$  V and  $+0.270$  V.

7. Set the HFS 9000 according to Table F-12.

Table F-12: HFS 9DG2 and HFS 9PG2 Output Level Checks, Second Settings

Control	Setting
Pulse menu, <b>High Level</b>	$-1.0$ V
Pulse menu, <b>Low Level</b>	$-2.0$ V

The output voltage reading on the DVM should be between  $-2.090$  V and  $-1.910$  V.

8. Change the Pulse menu **Polarity** item setting to **Complement**.

The output voltage reading on the DVM should be between  $-1.070$  V and  $-0.930$  V.

9. Move the feedthrough termination assembly to the channel complemented  $\overline{\text{OUTPUT}}$  if available (HFS 9PG2). The DVM is now set to monitor the complement output.

10. Set the HFS 9000 according to Table F–13.

**Table F–13: HFS 9PG2 Output Level Checks, Third Settings**

Control	Setting
Pulse menu, <b>Output</b>	Off
Pulse menu, <b>~Output</b>	On
Pulse menu, <b>Polarity</b>	Normal
Pulse menu, <b>High Level</b>	5.5 V
Pulse menu, <b>Low Level</b>	0 V

The output voltage reading on the DVM should be between 5.340 V and 5.660 V.

11. Change the Pulse menu **Polarity** item setting to **Complement**.

The output voltage reading on the DVM should be between –0.270 V and +0.270 V.

12. Set the HFS 9000 according to Table F–14.

**Table F–14: HFS 9PG2 Output Level Checks, Fourth Settings**

Control	Setting
Pulse menu, <b>High Level</b>	–1.0 V
Pulse menu, <b>Low Level</b>	–2.0 V

The output voltage reading on the DVM should be between –2.090 V and –1.910 V.

13. Change the Pulse menu **Polarity** item setting to **Normal**.

The output voltage reading on the DVM should be between –1.07 V and –0.93 V.

14. Repeat steps 1 through 13 for each of the HFS 9PG2 and HFS 9DG2 channels in the system.

15. Disconnect test setup.

**Output Level Checks  
(HFS 9PG1 Card Only)**

These tests check the output level in volts DC of each pulse generator channel. You will need to repeat these checks for each output channel; the number of times you repeat a check depends on the configuration of your HFS 9000. A reference to “the channel” is a reference to the particular channel being checked.

<b>Equipment Required</b>	One DVM (digital voltmeter, item 1) One BNC female to dual banana connector (item 2) One precision coaxial cable (item 3) One feedthrough termination (item 4) One threaded SMA female to SMA male slip-on connector (item 11).
---------------------------	---

1. Reset the HFS 9000.
2. Set the Digital Voltmeter to measure DC volts on Auto Range.
3. Construct the termination assembly by connecting the following items in the order listed:
  - a. one BNC female to dual banana connector (item 2)
  - b. one precision coaxial cable (item 3)
  - c. one feedthrough termination (item 4)
  - d. one BNC female to SMA male adapter (item 10)
  - e. one threaded SMA female to SMA male slip-on connector (item 11).
4. Connect the banana plug end of the termination assembly to the input of the DVM and connect the other end to the channel normal **OUTPUT** connector.
5. Set the HFS 9000 according to Table F–15.

**Table F–15: HFS 9PG1 Output Level Checks, First Settings**

<b>Control</b>	<b>Setting</b>
Pulse menu, <b>Channel</b>	The channel under test
Pulse menu, <b>Output</b>	On
Pulse menu, <b>-Output</b>	Off
Pulse menu, <b>Pulse Rate</b>	Off
Pulse menu, <b>Polarity</b>	Complement
Pulse menu, <b>High Level</b>	2.6 V
Pulse menu, <b>Low Level</b>	–0.4 V

The output voltage reading on the DVM should be between 2.498 V and 2.702 V.

6. Change the Pulse menu **Polarity** item setting to **Normal**.

The output voltage reading on the DVM should be between -0.562 V and -0.238 V.

7. Set the HFS 9000 according to Table F-16.

**Table F-16: HFS 9PG1 Output Level Checks, Second Settings**

Control	Setting
Pulse menu, <b>High Level</b>	-1.0 V
Pulse menu, <b>Low Level</b>	-2.0 V

The output voltage reading on the DVM should be between -2.090 V and -1.910 V.

8. Change the Pulse menu **Polarity** item setting to **Complement**.

The output voltage reading on the DVM should be between -1.07 V and -0.93 V.

9. Move the feedthrough termination assembly to the channel complemented OUTPUT. The DVM is now set to monitor the complement output.

10. Set the HFS 9000 according to Table F-17.

**Table F-17: HFS 9PG1 Output Level Checks, Third Settings**

Control	Setting
Pulse menu, <b>Output</b>	Off
Pulse menu, <b>-Output</b>	On
Pulse menu, <b>Polarity</b>	Normal
Pulse menu, <b>High Level</b>	2.6 V
Pulse menu, <b>Low Level</b>	-0.4 V

The output voltage reading on the DVM should be between 2.498 V and 2.702 V.

11. Change the Pulse menu **Polarity** item setting to **Complement**.

The output voltage reading on the DVM should be between -0.562 V and -0.238 V.

12. Set the HFS 9000 according to Table F-18.

**Table F-18: HFS 9PG1 Output Level Checks, Fourth Settings**

Control	Setting
Pulse menu, <b>High Level</b>	-1.0 V
Pulse menu, <b>Low Level</b>	-2.0 V

The output voltage reading on the DVM should be between -2.090 V and -1.910 V.

13. Change the Pulse menu **Polarity** item setting to **Normal**.

The output voltage reading on the DVM should be between -1.07 V and -0.93 V.

14. Repeat steps 1 through 13 for each of the HFS 9PG1 channels in the system.  
15. Disconnect test setup.

### Trigger Output Level

This check verifies the level of the HFS 9000 trigger output.

Equipment Required	
	One Tektronix 11801B Digital Sampling Oscilloscope or CSA803A Communication Signal Analyzer (item 5) with sampling head (item 6) Two SMA coaxial cables (item 8)

1. Connect an SMA cable from the HFS 9000 **TRIGGER OUTPUT** to the Channel 1 input of the DSO sampling head.
2. Connect an SMA cable from the DSO trigger input to the HFS 9000 Channel 1 output.
3. Reset the HFS 9000.
4. Initialize the DSO and select the Channel 1 sampling head input.

5. Press **AUTOSET** and set the HFS 9000 and DSO according to Table F–19.

**Table F–19: Settings for Trigger Output Check**

Control	Setting
HFS 9000:	
Pulse menu, <b>Period</b>	Press <b>SELECT</b> to change the <b>Period</b> item to a <b>Frequency</b> item
Pulse menu, <b>Frequency</b>	100 MHz
Pulse menu, <b>Output</b>	On
DSO:	
Main Size	2 ns
Vertical Size	200 mV
Vertical Offset	0
Main Position	Minimum
Measure	Min, Max, Amplitude

6. Measure maximum value is less than or equal to  $-0.5\text{ V}$ , the minimum value is greater than or equal to  $-1.5\text{ V}$  and the amplitude is greater than or equal to  $300\text{ mV}_{\text{p-p}}$ .

**Rise Time and Fall Time Checks (HFS 9PG1 and HFS 9DG1 Cards Only)**

These checks verify the rise time and fall times of HFS 9PG1 pulse card and HFS 9DG1 data time generator channels. You will check each HFS 9000 high speed channel in turn. A reference to “the channel” is a reference to the particular channel under test.

<b>Equipment Required</b>	One Tektronix 11801B Digital Sampling Oscilloscope or CSA803A Communication Signal Analyzer (item 5) with sampling head (item 6) Two SMA coaxial cables (item 8) One SMA 5X attenuator (item 7) One threaded SMA female to SMA male slip-on connector (item 11).
---------------------------	---

1. Reset the HFS 9000, then make the settings according to Table F–20.

Table F-20: Settings for Rise Time and Fall Time Checks

Control	Setting
Pulse menu, <b>Channel</b>	The channel under test
Pulse menu, <b>High Level</b>	Press <b>SELECT</b> to change the <b>High Level</b> item to an <b>Amplitude</b> item, and the <b>Low Level</b> item to an <b>Offset</b> item
Pulse menu, <b>Amplitude</b>	1.0 V
Pulse menu, <b>Offset</b>	0 V
Pulse menu, <b>Polarity</b>	Normal
Pulse menu, <b>Period</b>	Press <b>SELECT</b> to change the <b>Period</b> item to a <b>Frequency</b> item
Pulse menu, <b>Frequency</b>	100 kHz
Pulse menu, <b>Pulse Rate</b>	Normal
Pulse menu, <b>Output</b>	On
Pulse menu, <b>-Output</b>	Off

2. Initialize the DSO.
3. Connect an SMA cable from the HFS 9000 **TRIGGER OUT** connector to the **DIRECT** connector located in the **TRIGGER INPUTS** section of the DSO. Set the DSO to trigger on that signal. Turn on averaging on the DSO.



**CAUTION.** To avoid accidentally damaging the sampling head of the DSO, place a 5X SMA attenuator on the sampling head input. Voltages in excess of 3 volts may damage the input circuit.

4. After placing a 5X SMA attenuator on the sampling head input, connect an SMA cable from the 5X SMA attenuator to the HFS 9000 normal **OUTPUT** connector of the channel under test. To save time connecting the cable to other channels, use the SMA slip-on connector on the end of the cable that connects to the HFS.
5. Set the DSO to display the signal with 50 mV/div (4 divisions) vertically at zero offset. Set the DSO time base to 1  $\mu$ s/div horizontally. Set the DSO **MAIN POSITION** to minimum.

6. Display the DSO measurement menu and turn on **RISE** and **FALL** measurements. Touch the **RISE** selector at the bottom of the DSO screen to display the **RISE** measurement parameters. Set these parameters according to Table F-21.

**Table F-21: DSO Settings for Rise/Fall Time Checks**

DSO Control	Setting
Left Limit	0%
Right Limit	100%
Proximal	20%
Distal	80%
Tracking	On
Level Mode	Relative

7. Once the DSO captures high and low levels, turn off tracking.
8. Set the DSO sweep speed to 500 ps/div and position the first rising edge at center screen. The measured rise time should be less than 200 ps for HFS 9PG1 cards, and less than 250 ps for a HFS 9DG1 cards. (Use waveform averaging to stabilize the measurement.)
9. Change the Pulse menu **Polarity** item setting to Complement. The measured fall time should be less than 200 ps for HFS 9PG1 cards, and less than 250 ps for HFS 9DG1 cards.
10. Repeat steps 1 through 9 for each of the HFS 9PG1 or HFS 9DG1 card channels in the system. (For Not Output channels, set **Output** off and **~Output** on.)
11. Disconnect test setup.



### Rise Time and Fall Time Checks (HFS 9PG2 and HFS 9DG2 Cards Only)

These checks verify the rise time and fall times of HFS 9PG2 pulse card and HFS 9DG2 data time generator channels. You will check each HFS 9000 high speed channel in turn. A reference to “the channel” is a reference to the particular channel under test.

<b>Equipment Required</b>	One Tektronix 11801B Digital Sampling Oscilloscope or CSA803A Communication Signal Analyzer (item 5) with sampling head (item 6) Two SMA coaxial cables (item 8) One SMA 5X attenuator (item 7) One threaded SMA female to SMA male slip-on connector (item 11).
---------------------------	---

1. Reset the HFS 9000, then make the settings listed in Table F–22.

**Table F–22: Settings for Rise Time and Fall Time Checks**

<b>Control</b>	<b>Setting</b>
Pulse menu, <b>Channel</b>	The channel under test
Pulse menu, <b>High Level</b>	Press <b>SELECT</b> to change the <b>High Level</b> item to an <b>Amplitude</b> item, and the <b>Low Level</b> item to a <b>Offset</b> item
Pulse menu, <b>Amplitude</b>	1.0 V
Pulse menu, <b>Offset</b>	0 V
Pulse menu, <b>Polarity</b>	Normal
Pulse menu, <b>Transition</b>	800 ps
Pulse menu, <b>Period</b>	Press <b>SELECT</b> to change the <b>Period</b> item to a <b>Frequency</b> item
Pulse menu, <b>Frequency</b>	100 kHz
Pulse menu, <b>Pulse Rate</b>	Normal
Pulse menu, <b>Output</b>	On
Pulse menu, <b>-Output</b>	Off

2. Connect an SMA cable from the HFS 9000 **TRIGGER OUT** connector to the **DIRECT** connector located in the **TRIGGER INPUTS** section of the DSO. Set the DSO to trigger on that signal.



**CAUTION.** To avoid accidentally damaging the sampling head of the DSO, place a 5X SMA attenuator on the sampling head input. Voltages in excess of 3 volts may damage the input circuit.

3. After placing a 5X SMA attenuator on the sampling head input, connect an SMA cable from the 5X SMA attenuator to the HFS 9000 normal **OUTPUT** connector of the channel under test. To save time connecting the cable to other channels, use the SMA slip-on connector on the end of the cable that connects to the HFS.
4. Set the DSO to display the signal with 50 mV/div (4 divisions) vertically at zero offset. Set the DSO time base to 1  $\mu$ s/div horizontally. Set the DSO **MAIN POSITION** to minimum.
5. Display the DSO measurement menu and turn on **RISE** and **FALL** measurements. Touch the **RISE** selector at the bottom of the DSO screen to display the **RISE** measurement parameters. Set these parameters according to Table F-23.

Table F-23: DSO Settings for Rise/Fall Time Checks

DSO Control	Setting
Left Limit	0%
Right Limit	100%
Proximal	20%
Distal	80%
Tracking	On
Level Mode	Relative

6. Once the DSO captures high and low levels, turn off tracking.
7. Set the DSO sweep speed to 500 ps/div and position the first rising edge at center screen. The measured rise time should be between 420 ps and 1.18 ns (HFS 9PG2 & HFS 9DG2 cards). (Use waveform averaging to stabilize the measurement.)
8. Change the Pulse menu **Polarity** item setting to Complement. The measured fall time should be between 420 ps and 1.18 ns (HFS 9PG2 & HFS 9DG2 cards).
9. Change the Pulse menu **Polarity** item setting to Normal. Set the Pulse menu **Transition** item to 5 ns.
10. Set the DSO time base to 5 ns/div. Use the RISE measurement to verify that the rise time is between 4.2 ns and 5.8 ns (HFS 9PG2 & HFS 9DG2 cards).
11. Change the Pulse menu **Polarity** item setting to Complement. The measured fall time on the DSO should be between 4.2 ns and 5.8 ns (HFS 9PG2 & HFS 9DG2 cards).

12. Repeat steps 1 through 11 for each of the HFS 9PG2 or HFS 9DG2 card channels in the system. (For Not Output channels, set **Output** off and **~Output** on.)
13. Disconnect test setup.

### Edge Placement Checks

These checks verify the accuracy of the pulse delays and pulse widths. You will check each HFS 9000 channel in turn. A reference to “the channel” is a reference to the particular channel being checked in this repetition.

<b>Equipment Required</b>	One Tektronix 11801B Digital Sampling Oscilloscope or CSA803A Communication Signal Analyzer (item 5) with sampling head (item 6) Two SMA coaxial cables (item 8) One threaded SMA female to SMA male slip-on connector (item 11).
---------------------------	---

1. Reset the HFS 9000, then make the settings according to Table F–24.

**Table F–24: Settings for Edge Placement Checks**

<b>Control</b>	<b>Setting</b>
Pulse menu, <b>Channel</b>	The channel under test
Pulse menu, <b>High Level</b>	Press <b>SELECT</b> to change the <b>High Level</b> item to an <b>Amplitude</b> item, and the <b>Low Level</b> item to an <b>Offset</b> item
Pulse menu, <b>Amplitude</b>	1.0 V
Pulse menu, <b>Offset</b>	0 V
Pulse menu, <b>Period</b>	Press <b>SELECT</b> to change the <b>Period</b> item to a <b>Frequency</b> item
Pulse menu, <b>Frequency</b>	100 kHz
Pulse menu, <b>Output</b>	On

2. If the channel is a Variable Rate (HFS 9PG2 or HFS 9DG2) channel, set transition to the lowest (fastest) rise time possible. (A quick way to do this is to enter “0” on the numeric keypad.)
3. Connect an SMA cable from the HFS 9000 **TRIGGER OUT** connector to the **DIRECT** connector located in the **TRIGGER INPUTS** section of the DSO.
4. Connect an SMA cable from the normal **OUTPUT** connector of the HFS 9000 channel under test to the sampling head input of the DSO. To save

time connecting the cable to other channels, use the SMA slip-on connector on the end of the cable that connects to the HFS.

5. Initialize the DSO, then set the DSO to display a triggered signal with 200 mV/div (5 divisions) vertically at zero offset. Set the DSO time base to 1  $\mu$ s/div horizontally. Set the DSO **MAIN POSITION** to minimum.
6. Display the DSO measurement menu and turn on **WIDTH** and **CROSS** measurements. On the DSO, touch the **WIDTH** selector at the bottom of the DSO screen to display the width measurement parameters. Set the DSO width **LEVEL MODE** parameter to **RELATIVE**. Turn the DSO tracking on.
7. On the DSO, turn tracking off when the high and low levels have been acquired.
8. Set the DSO sweep speed to 500 ps/div. Position the rising edge of the displayed waveform at the center of the DSO screen. On the DSO, save the cross measurement as the reference (in the Compare & References pop-up menu).
9. On the DSO, turn **COMPARE** on.
10. Refer to Table F-25 or F-26, as appropriate, and adjust for each of the specified Pulse menu **Lead Delay** settings listed in the left column. For each **Lead Delay** value, verify that the DSO **CROSS** measurement falls within the limits specified in the middle and right columns. You may need to adjust the DSO horizontal position to keep the rising edge on the screen.

**Table F-25: Lead Delay Limits for HFS 9PG1 and HFS 9PG2**

HFS 9000 Pulse Menu Lead Delay Setting	DSO CROSS Measurement Minimum	DSO CROSS Measurement Maximum
100 ps	-201 ps	401 ps
500 ps	195 ps	805 ps
1 ns	690 ps	1.31 ns
5 ns	4.65 ns	5.35 ns
10 ns	9.60 ns	10.4 ns
50 ns	49.2 ns	50.8 ns
100 ns	98.7 ns	101.3 ns

Table F-26: Lead Delay Limits for HFS 9DG1 and HFS 9DG2

HFS 9000 Pulse Menu Lead Delay Setting	DSO CROSS Measurement Minimum	DSO CROSS Measurement Maximum
100 ps	49 ps	151 ps
500 ps	445 ps	555 ps
1 ns	940 ps	1.060 ns
5 ns	4.9 ns	5.1 ns
10 ns	9.85 ns	10.15 ns
50 ns	49.45 ns	50.55 ns
100 ns	98.95 ns	101.05 ns

11. Set the DSO horizontal position to minimum. Turn the DSO COMPARE off.
12. On the HFS 9000, use the **SELECT** button to change the Pulse menu **Duty Cycle** item to a **Width** item. Set the **Lead Delay** item to zero.
13. Skip this step if the channel is a Variable Rate (HFS 9PG2 or HFS 9DG2) channel. Refer to Table F-27 or Table F-28. Adjust the DSO horizontal position to display the first rising edge at screen. While observing the width measurement readout on the DSO, adjust the HFS 9000 **Pulse Width** item with the knob in **Fine** mode until each reading in the left column is achieved on the DSO. Then, observe the **Width** item setting on the HFS 9000 that achieved this result. Verify that the HFS 9000 value is within the limits specified in the middle and right columns. You may need to adjust the DSO horizontal position to keep the pulse on the screen.

Table F-27: Width Variance Limits for HFS 9PG1

DSO WIDTH Measurement Readout	HFS 9000 Width Setting Minimum	HFS 9000 Width Setting Maximum
500 ps	195 ps	805 ps
750 ps	443 ps	1.06 ns
1 ns	690 ps	1.31 ns

Table F-28: Width Variance Limits for HFS 9DG1

DSO WIDTH Measurement Readout	HFS 9000 Width Setting Minimum	HFS 9000 Width Setting Maximum
650 ps	594 ps	732 ps
750 ps	693 ps	833 ps
1 ns	940 ps	1.085 ns

14. Refer to Tables F-29, F-30 and F-31, as appropriate, and set each of the specified Pulse menu **Width** settings listed in the left column. For each **Width** setting, verify that the DSO WIDTH measurement falls within the limits specified in the middle and right columns. Adjust the horizontal time/division as necessary to keep a full pulse displayed on screen.

Table F-29: Width Limits for HFS 9PG1 and HFS 9PG2

HFS 9000 Pulse Menu Width Setting	DSO WIDTH Measurement Minimum		DSO WIDTH Measurement Maximum
	HFS 9PG1	HFS 9PG2	
5 ns	4.65 ns	4.45 ns	5.35 ns
10 ns	9.60 ns	9.40 ns	10.4 ns
50 ns	49.2 ns	49.2 ns	50.8 ns
100 ns	98.7 ns	98.7 ns	101.3 ns
500 ns	494.7 ns	494.7 ns	505.3 ns
1 $\mu$ s	990 ns	990 ns	1.01 $\mu$ s

Table F-30: Width Limits for HFS 9DG1

HFS 9000 Pulse Menu Width Setting	DSO WIDTH Measurement Minimum	DSO WIDTH Measurement Maximum
5 ns	4.875 ns	5.1 ns
10 ns	9.825 ns	10.15 ns
50 ns	49.45 ns	50.55 ns
100 ns	98.95 ns	101.05 ns
500 ns	494.95 ns	505.05 ns
1 $\mu$ s	990 ns	1.01 $\mu$ s

Table F-31: Width Limits for HFS 9DG2 1

HFS 9000 Pulse Menu Width Setting	DSO WIDTH Measurement Minimum	DSO WIDTH Measurement Maximum
5 ns	4.500 ns	5.1 ns
10 ns	9.450 ns	10.15 ns
50 ns	49.25 ns	50.55 ns
100 ns	98.75 ns	101.05 ns
500 ns	494.8 ns	505.1 ns
1 $\mu$ s	990 ns	1.01 $\mu$ s

15. Repeat steps 1 through 14 for each of the channels in the system. (For Not Output channels, set **Output** off and **~Output** on).

16. Disconnect test setup.

### Frequency Accuracy Check

<b>Equipment Required</b>	One Tektronix 11801B Digital Sampling Oscilloscope or CSA803A Communication Signal Analyzer (item 5) with sampling head (item 6) One SMA coaxial cable (item 8) One threaded SMA female to SMA male slip-on connector (item 11).
---------------------------	--

1. Reset the HFS 9000, then use the SELECT button to change the Pulse menu **Period** item to a **Frequency** item.
2. Connect an SMA cable from the HFS 9000 TRIGGER OUT connector to the DIRECT connector located in the TRIGGER INPUTS section of the DSO. Set the DSO to trigger on that signal.
3. Connect an SMA cable from the normal OUTPUT connector of any High Speed HFS 9000 channel to the sampling head input of the DSO. To save time connecting the cable to other channels, use the SMA slip-on connector on the end of the cable that connects to the HFS.

**NOTE.** If you have any HFS 9PG2 channels, set the Pulse menu **Pulse Rate** item to Half for those channels. If you have Variable Rate or HFS 9DG2 channels, use one of them for this test.

4. Turn on the output of the HFS 9000 channel you are using.

5. Set the DSO to display the signal with 200 mV/div vertically and a vertical offset of -1.3 V. Set the DSO time base to 500 ps/div horizontally. Set the DSO MAIN POSITION to minimum.
6. Display the DSO measurement menu and turn on the FREQUENCY measurement. On the DSO, turn TRACKING on and turn on AVERAGING with AVGN set to 32.
7. Refer to Tables F-32, F-33, or F-34 as appropriate, and adjust for each of the specified Pulse menu **Frequency** settings listed in the left column. For each **Frequency** value, verify that the DSO FREQUENCY measurement falls within the limits specified in the middle and right columns. Adjust the horizontal size and position to make the display of a single cycle fill the DSO screen.

**Table F-32: Frequency Limits (HFS 9PG1 & HFS 9DG1)**

HFS 9000 Pulse Menu Frequency Setting	DSO FREQUENCY Minimum	DSO FREQUENCY Maximum
50 kHz	49.5 kHz	50.5 kHz
324 MHz	320.8 MHz	327.2 MHz
326 MHz	322.7 MHz	329.3 MHz
400 MHz	396.0 MHz	404.0 MHz
433 MHz	428.7 MHz	437.3 MHz
466 MHz	461.3 MHz	470.7 MHz
500 MHz	495.0 MHz	505.0 MHz
533 MHz	527.7 MHz	538.3 MHz
566 MHz	560.3 MHz	571.7 MHz
600 MHz	594.0 MHz	606.0 MHz
630 MHz	623.7 MHz	636.3 MHz

**Table F-33: Frequency Limits (HFS 9PG2)**

HFS 9000 Pulse Menu Frequency Setting	DSO FREQUENCY ( $\div 2$ ) Minimum	DSO FREQUENCY ( $\div 2$ ) Maximum
100 kHz	49.5 kHz	50.5 kHz
324 MHz	160.4 MHz	163.6 MHz
326 MHz	161.4 MHz	164.6 MHz
400 MHz	198 MHz	202 MHz
433 MHz	214.3 MHz	218.7 MHz



Table F-33: Frequency Limits (HFS 9PG2) (Cont.)

HFS 9000 Pulse Menu Frequency Setting	DSO FREQUENCY ( $\div 2$ ) Minimum	DSO FREQUENCY ( $\div 2$ ) Maximum
466 MHz	230.7 MHz	235.3 MHz
500 MHz	247.5 MHz	252.5 MHz
533 MHz	263.8 MHz	269.2 MHz
566 MHz	280.2 MHz	285.8 MHz
600 MHz	297.0 MHz	303.0 MHz

Table F-34: Frequency Limits (HFS 9DG2)

HFS 9000 Pulse Menu Frequency Setting	DSO FREQUENCY Minimum	DSO FREQUENCY Maximum
50 kHz	49.5 kHz	50.5 kHz
162 MHz	160.4 MHz	163.6 MHz
163 MHz	161.4 MHz	164.6 MHz
200 MHz	198.0 MHz	202.0 MHz
216.5 MHz	214.3 MHz	218.7 MHz
233 MHz	230.7 MHz	235.3 MHz
250 MHz	247.5 MHz	252.5 MHz
266.5 MHz	263.8 MHz	269.2 MHz
283 MHz	280.2 MHz	285.8 MHz
300 MHz	297.0 MHz	303.0 MHz

**Phase Lock Check**

<b>Equipment Required</b>	Generator, Leveled Sine Wave (item 9) BNC female to SMA male adapter (item 10).
---------------------------	--

This check verifies that the phase lock system is capable of detecting, accurately measuring, and holding an input signal.

---

***NOTE.** If the HFS 9009 cannot determine the phase lock frequency, an error message is displayed. This will happen if the phase lock signal is not stable and continuous, or if the phase lock signal is outside the allowed frequency range, or if the HFS 9009 needs calibrating.*

---

1. Reset the HFS 9000.
2. Set the signal generator for an amplitude of  $0.8 V_{p-p}$  and a frequency of 250 MHz. Connect the signal to the HFS 9000 **PHASE LOCK IN** connector. If your generator does not have better than 1% frequency accuracy, use the FREQUENCY measurement capability of the DSO to set the generator frequency to within 1%.
3. Set the Time Base menu **PhaseLockIn** item to On.
4. Check that the input frequency is correctly displayed on the HFS 9000 screen immediately above the menu area.
5. Wait at least five seconds and make sure that the HFS 9000 retains phase lock. (If phase lock is lost, you will see an error message.)
6. Set the Time Base menu **PhaseLockIn** item to Off.
7. Repeat steps 3 through 6 with the signal generator set to 594 MHz. If your generator does not have better than 1% frequency accuracy, use the FREQUENCY measurement capability of the DSO to set the generator frequency to within 1%.
8. You may optionally check other frequencies as well. Low frequency checks will require a different generator (such as a square wave generator) which meets to 20% to 80% risetime requirement of 10 ns or less for the **PHASE LOCK IN** input.
9. Disconnect test setup.



# Glossary

**Address**

An identifier for devices on a GPIB bus. No two devices on a bus may have the same address.

**Alias**

A user-defined programming command that is an abbreviation for a sequence of other programming commands.

**Argument**

A quantity, quality, restriction, or limit that is part of a programming command.

**ASCII (American Standard Code for Information Interchange)**

An encoding of the alphabet and other characters into a binary coding system.

**Amplitude**

The voltage difference between logic low and logic high. See also *Levels*.

**Auto Mode**

A time base mode where the HFS 9000 produces a continuous series of pulse windows, without waiting for any trigger events and without any startup delays in the series of pulses.

**Auto-Burst Mode**

A time base mode where the HFS 9000 produces bursts of pulses continuously. The HFS 9000 creates its own trigger events. There is a delay between pulse bursts.

**Baud Rate**

The transmission speed used with an RS-232-C interface.

**Break**

In RS-232-C communications, a temporary disconnection of the signal path used to communicate status.

**Burst**

A group of generated pulse windows initiated by a single trigger event.

**Burst Mode**

A time base mode where the HFS 9000 produces a burst of pulses whenever a trigger event is detected. Trigger events can be a signal at the **TRIGGER IN** connector, a press of the **MANUAL TRIGGER** button, execution of a remote \*TRG command, or execution of a Group Execute Trigger.

**Calibration**

The act of adjusting the internal adjustments of the HFS 9000 to internal timing and voltage standards. The HFS 9000 provides automation assistance for calibration.

**Channel**

A pulse generator. Each channel has two outputs which are true logical complements of each other.

**Chan Delay**

A deskew applied to a channel to synchronize the timing of pulses relative to other channels and to the trigger. When synchronized, the time zero references for all channels occur simultaneously at the device under test (DUT).

**Command**

A directive sent to the HFS 9000 through a programming interface, either GPIB or RS-232-C. Commands are of two types: set commands and query commands. Set commands to direct the HFS9000 to perform some action. Query commands initiate a response message from the HFS 9000.

**Common Command**

A command that is common to all GPIB devices, as specified in IEEE Std. 488.2-1987. See also *Device Command*.

**DCE (Data Communication Equipment)**

A polarity standard for RS-232-C interfaces. Equipment with DCE ports connect directly to equipment with DTE (Data Terminal Equipment) ports. Special cabling or connectors are required to connect two DCE ports.

**Debug Mode**

A mode of the HFS 9000 that is useful when debugging sequences of remote programming commands. In this mode, a displayed window shows each command as it is being executed, and shows several control settings.

**Device Command**

A command that is unique to the HFS 9000. See also *Common Command*.

**Device Under Test (DUT)**

The device that the HFS 9000 is sending pulses to.

**Delay**

When using the RS-232-C interface, the amount of time that the HFS 9000 waits after receiving a query command before sending the response. Contrast with *Lead Delay*, *Trail Delay*, and *Chan Delay*.

**Deskew**

An adjustment of the timing of an event to compensate for delays in other equipment, or for cabling propagation delays. See *Chan Delay*, *Deskew*, and *Pretrigger*.

**DTE (Data Terminal Equipment)**

A polarity standard for RS-232-C interfaces. Equipment with DTE ports connect directly to equipment with DCE (Data Communication Equipment) ports. Special cabling or connectors are required to connect two DTE ports.

**Duty Cycle**

The percentage of pulse window time that a pulse generator outputs a logical high state. See also *Lead Delay*, *Phase*, *Trail Delay*, and *Width*.

**Echo**

An RS-232-C mode where the HFS 9000 sends back to the computer or terminal a copy of every data character received.

**EOI (End or Identify)**

A signal line of the GPIB used to indicate the end of message for talker devices.

**EOL (End of Line)**

The sequence of character(s) the HFS 9000 puts at the end of every query response when using the RS-232-C interface.

**Event**

An occurrence that causes a GPIB instrument to send a signal to the controller. An event is usually accompanied by a message.

**Factory**

A form of reset that restores the HFS 9000 to a known state. Factory is similar to Reset, except that Factory also deletes the definition of all aliases and purges all settings. Contrast with *Reset*.

**Flagging**

When using the RS-232-C interface, a method of preventing data overflow of buffers. Shortly before it can handle no more data, each device flags the sending device to stop sending data until the flag is removed.

**Frame Sync**

When using phase lock, a method of providing a trigger event that is synchronized with the phase lock (external clock) signal.

**Frequency**

A specification of the rate of occurrence of pulse windows; the inverse of period.

**GPIB (General Purpose Interface Bus)**

A bus standard that allows instruments to be connected in a network and programmed with a controller. This standard is formally defined in ANSI Standard *IEEE 488.2-1987*.

**Header**

The name portion of a command. The header is composed of mnemonics separated by colon (:) characters.

**High Speed Pulse Generator Card**

A pulse generator card having high frequency capability. Channels on the high speed pulse generator card cannot vary their transition time (rise and fall time). Contrast with *Var Rate Pulse Generator Card*.

**IEEE 488.2-1987**

A bus standard that allows instruments to be connected in a network and programmed with a controller. Also known as *GPIB*.

**Lead Delay**

The delay between the beginning of a pulse window and the first edge of the pulse associated with that pulse window. See also *Duty Cycle*, *Phase*, *Trail Delay*, and *Width*.

**Levels**

The voltages used by a channel for logic high and logic low. Levels can be specified in terms of amplitude and offset, or in terms of high level and low level. See also *Limiting*.

**Limiting**

Gives the ability to protect devices under test by applying voltage limits simultaneously to the levels settings of all pulse generator channels.

**Listener**

A device on a GPIB bus that receives messages. See also *Talker*.

**Manual Trigger**

Using the press of a button as the trigger event.

**Mnemonic**

A name element of a header. Several mnemonics may be joined by colon (:) characters to form a complete command header.

**Offset**

The center voltage half-way between the logic high and logic low levels. Amplitude is centered on the offset.

**Out Period**

The particular pulse window within a pulse burst with which the trigger out signal is synchronized.

**Parity**

An error-checking communication parameter used with the RS-232-C interface.

**Period**

A specification of the duration of pulse windows; the inverse of frequency.

**Phase**

The time between the beginning of the pulse window and the beginning of the pulse, in terms of percentage of the pulse window. See also *Duty Cycle*, *Lead Delay*, *Trail Delay*, and *Width*.

**Phase Lock**

A means of using an external signal as the time base clock, instead of using the internal HFS 9000 clock.

**Pretrigger**

A deskew applied to the output trigger to make it occur before it normally would. Pretrigger compensates for cabling delays and input delays in the instrument being triggered.

**Programming Command**

A directive sent to the HFS 9000 through a programming interface, either GPIB or RS-232-C. Commands are of two types: set commands and query commands. Set commands direct to the HFS9000 to perform some action. Query commands initiate a response message from the HFS 9000.

**Pulse Window**

A span of time defined by the time base during which the pulse generators produce a single pulse.

**Query Commands**

A directive sent to the HFS 9000 through a programming interface, either GPIB or RS-232-C. Query commands initiate a response message from the HFS 9000. See also *Set Commands*.

**Reset**

Restoring the HFS 9000 to a known state. Contrast with *Factory*.

**RS-232-C**

An interface that can connect the HFS 9000 to a computer or terminal so that the instrument can be remotely controlled.

**Self Test**

A suite of automated tests that verify proper functioning of the HFS 9000 circuitry.

**Serial Port**

The RS-232-C interface connector on the HFS 9000 front panel.

**Set Commands**

A directive sent to the HFS 9000 through a programming interface, either GPIB or RS-232-C. Set commands direct the HFS 9000 to perform some action. See also *Query Commands*.



**Setting**

The state of all parameters and switches. Several settings may be saved and individually recalled later.

**Startup Delay**

A fixed time interval between the trigger event and the time zero reference.

**Stop Bits**

In RS-232-C communications, extra synchronizing bits appended to the data stream.

**SRQ (Service Request)**

On a GPIB bus, a signal that requests an asynchronous event.

**Syntax**

The grammatical rules by which programming commands are constructed.

**Tek Codes and Formats**

A standard implementation of programming commands that ensures similar commands for similar functions, and ensures programming command compatibility among instruments.

**Talker**

A device on a GPIB bus that sends messages. See also *Listener*.

**Terminal Emulation**

Using a program on a computer to simulate a simple terminal running an RS-232-C interface.

**Time Base**

The circuitry that governs all timed events in the HFS 9000. The time base defines pulse windows which are the spans of time within which pulse generators generate a single pulse.

**Time Base Mode**

The way the time base interacts with trigger events and generates bursts of pulse windows. See *Auto Mode*, *Auto-Burst Mode*, and *Burst Mode*.

**Time Zero Reference**

An imaginary time when pulse burst begins. The beginning of the first pulse window of a burst. Chan Delay allows the adjustment of the time zero references for multiple channels to be simultaneous. See *Chan Delay* and *Deskew*.

**Trail Delay**

The time between the beginning of a pulse window and the second edge of the generated pulse. See *Duty Cycle*, *Lead Delay*, *Phase*, and *Width*.

**Transducer Mode**

A mode where a channel output timing is governed solely by a signal applied to the channel **Transducer In** connector.

**Transition (Var Rate pulse cards only)**

The rise time and fall time of transitions between logic levels.

**Trigger In**

An external signal that initiates the time base burst of pulse windows.

**Trigger Out**

A signal generated by the HFS 9000 that is synchronous with a particular pulse window in a burst.

**Var Rate Pulse Generator Card**

A pulse generator card having variable transition time (rise and fall time) capability. Channels on the var rate pulse generator card have limited frequency capability. Contrast with *High Speed Pulse Generator Card*.

**Width**

The time between the first and second edges of a generated pulse. See *Duty Cycle*, *Lead Delay*, *Phase*, and *Trail Delay*.

**Window**

A span of time defined by the time base during which the pulse generators produce a single pulse.

**XON/XOFF**

An RS-232-C flagging standard to prevent buffer overflow. Two ASCII characters are used: DC3 (Control-S or hex 11) flags the sending device to stop transmission, and DC1 (Control-Q or hex 13) indicates that transmission can resume.





# Index

## A

- Abbreviating, Command, 3–12
- Address
  - Channel, 2–9
  - GPIB, 2–33, 3–4
- Address** menu item, 2–33, 3–4
- Alias
  - Define, 3–27
  - Delete, 3–28
  - Query, 3–27
  - State, 3–29
- ALIAS command
  - ALIAS:CATalog?, 3–27
  - ALIAS:DEFine, 3–27
  - ALIAS:DELEte:ALL, 3–28
  - ALIAS:DELEte:NAME, 3–28
  - ALIAS:STATE, 3–29
- ALLEV?, 3–29
- Amplitude** menu item, 2–36, 2–46
- Amplitude view, 2–36, 2–46, 3–75
- Argument, Command, 3–10
- Arrow button, 1–3, 2–2, 2–3, 2–4
- ASCII, 3–9
  - Character table, C–2
- ATN debug indicator, C–4
- Auto, Time base mode, 1–7, 2–63
- Auto-burst, Time base mode, 2–20
- Auto, Time base mode, 2–20
- Auto-burst, Time base mode, 1–7, 2–63

## B

- BACKSPACE** button, 1–8
- Baud Rate** menu item, 2–55, 3–5
- Blinking, Menu items, 2–48, 2–64
- Block, Command argument, 3–15
- Block End** menu item, 2–21, 2–24
- Block Start** menu item, 2–21, 2–24
- BNF (Backus-Naur form), 3–9
- Break, 3–9
- Burst, Time base mode, 1–7, 2–1, 2–62
- Burst, Time base mode, 2–20
- Button
  - Arrow, 1–3, 2–2, 2–3, 2–4
  - BACKSPACE**, 1–8
  - ENTER**, 1–8
  - FINE**, 1–7, 2–2, 2–3
  - MAIN MENU**, 1–2, 2–2, 2–3, 2–4

- MANUAL TRIGGER**, 1–11, 2–2, 2–3, 2–62, 2–64, 2–67
- NEXT CHANNEL**, 2–2, 2–3, 2–11, 2–25, 2–36, 2–46
- Numeric keypad, 1–8
- ON/STANDBY**, 2–2, 2–3
- OUTPUT**, 1–11, 2–2, 2–3
- PREVIOUS CHANNEL**, 2–2, 2–3, 2–11, 2–25, 2–36, 2–46
- RUN/STOP**, 2–2, 2–3
- SELECT**, 1–3, 2–2, 2–3, 2–4
- SRQ**, 2–2, 2–3, 2–31
- UNDO**, 1–9, 2–2, 2–3

## C

- CAL command
  - CAL:CID, 3–30
  - CAL:CONSTant?, 3–30
- Cal/Deskew menu, 1–4, 2–7, 2–25, 2–43, 2–59, 2–61, 2–67
- Calibrate** menu item, 2–7
- Calibration, 2–7, F–12
  - Constant, 3–30
  - Interval, 2–7
  - Memory, 2–7, 2–51
  - Settings, 2–7
- Card ID, 2–44, 3–30
- Card-channel, Command mnemonic, 3–16
- Chan Delay** menu item, 2–25
- Channel
  - Address, 2–9
  - Channel View, 3–65, 3–68
  - Command argument, 3–16
  - Connectors, 2–10
  - Data Copy, 3–66
  - Data Fill (Binary), 3–63
  - Data Input/Output, 3–65
  - Data Input/Output (Binary), 3–61
  - Data Swap, 3–67
  - Delay, 2–25
  - Deskew, 2–25
  - Location, 2–9
  - Naming, 2–14–2–24
  - Output
    - Amplitude, 2–46, 3–59
    - Channel delay, 2–25, 3–63
    - Duty cycle, 2–48, 3–67
    - Fall time, 2–48, 3–83

- High, 2–36, 2–37, 2–46, 3–69
- Lead delay, 2–47, 3–71
- Limits, 2–37, 3–70, 3–73
- Low, 2–36, 2–37, 3–74
- Offset, 2–46, 3–76
- On/off, 2–2, 2–3, 2–10, 2–14, 2–43, 2–46, 3–64, 3–77
- Phase, 2–48, 3–78
- Polarity, 2–46, 2–49, 3–79
- Pulse rate, 2–49, 3–79
- Pulse width, 2–48, 3–85
- Rise time, 2–48, 3–83
- Trail delay, 2–48, 3–81
- Transducer input, 2–49, 3–83
- Transition, 2–48, 3–83
- Voltages, 2–36, 2–46, 3–69, 3–74
- Width, 2–48, 3–85
- Selecting, 2–11
- Signal, 3–80
- Signal Channel View, 3–100
- Signal Data, 3–101
- Signal Data Copy, 3–102
- Signal Type, 3–84, 3–104
- Channel** menu item, 2–25, 2–36, 2–46
- Channel** menu item, 2–21
- Channels, 2–9
- Check Procedures, F–13
- Clear Block** menu item, 2–21
- Clear Status, 3–31
- \*CLS command, 3–31
- Command
  - Abbreviating, 3–12
  - ALIAS:CATalog?, 3–27
  - ALIAS:DEFine, 3–27
  - ALIAS:DELEte:ALL, 3–28
  - ALIAS:DELEte:NAME, 3–28
  - ALIAS:STATE, 3–29
  - Argument, 3–10
  - Block argument, 3–15
  - CAL:CID, 3–30
  - CAL:CONStant?, 3–30
  - Card-channel mnemonic, 3–16
  - Channel argument, 3–16
  - \*CLS, 3–31
  - Common, List, 3–21
  - Concatenating, 3–12
  - DESE, 3–32, 3–131
  - Device, List, 3–22
  - \*ESE, 3–33, 3–132
  - \*ESR?, 3–34, 3–129
  - EVENT?, 3–34
  - EVMSG?, 3–34
  - FACTORY, 3–35
  - FPAN?, 3–38
  - FPAN:ADVance, 3–38
  - FPAN:BEND, 3–39
  - FPAN:BSIZE, 3–40
  - FPAN:BSart, 3–41
  - FPAN:CONStant, 3–41
  - FPAN:COPIes, 3–42
  - FPAN:CORDer, 3–43
  - FPAN:DCHannel, 3–40, 3–43
  - FPAN:DITem, 3–44
  - FPAN:DMENU, 3–45
  - FPAN:DNCHannel, 3–45
  - FPAN:DNSignal, 3–46
  - FPAN:DNStart, 3–46
  - FPAN:DSEtting, 3–47
  - FPAN:DSIGnal, 3–47
  - FPAN:DVEctor, 3–48
  - FPAN:FSCale, 3–49
  - FPAN:KEY, 3–49
  - FPAN:KRESolution, 3–51
  - FPAN:MESSage, 3–52
  - FPAN:METHod, 3–52
  - FPAN:SORDer, 3–53
  - FPAN:VRADix, 3–54
  - HEADER, 3–54
  - Header, 3–10
  - \*IDN?, 3–55
  - List
    - Common command, 3–21
    - Device command, 3–22
  - \*LRN?, 3–56
  - Message, 3–10
  - Mnemonic, 3–10
  - Numeric argument, 3–16
  - \*OPC, 3–57
  - \*OPT?, 3–57
  - PGEN<x>?, 3–58
  - PGEN<x>:CH<n>?, 3–59
  - PGEN<x>:CH<n>:AMPLitude, 3–59
  - PGEN<x>:CH<n>:BDATA, 3–61
  - PGEN<x>:CH<n>:BDATA:FILL, 3–63
  - PGEN<x>:CH<n>:CDElay, 3–63
  - PGEN<x>:CH<n>:COUtput, 3–64
  - PGEN<x>:CH<n>:DATA, 3–65
  - PGEN<x>:CH<n>:DATA:COpy, 3–66
  - PGEN<x>:CH<n>:DATA:SWAP, 3–67
  - PGEN<x>:CH<n>:DCYcle, 3–67
  - PGEN<x>:CH<n>:CVIew, 3–65
  - PGEN<x>:CH<n>:DRADix, 3–68
  - PGEN<x>:CH<n>:HIGH, 3–69
  - PGEN<x>:CH<n>:HLIMit, 3–70
  - PGEN<x>:CH<n>:LDElay, 3–71
  - PGEN<x>:CH<n>:LHOLd, 3–72

- PGEN<x>:CH<n>:LIMit, 3–73
- PGEN<x>:CH<n>:LLIMit, 3–73
- PGEN<x>:CH<n>:Low, 3–74
- PGEN<x>:CH<n>:LVIEw, 3–75
- PGEN<x>:CH<n>:OFFSet, 3–76
- PGEN<x>:CH<n>:OUTPut, 3–77
- PGEN<x>:CH<n>:PHASe, 3–78
- PGEN<x>:CH<n>:POLarity, 3–79
- PGEN<x>:CH<n>:PRATe, 3–79
- PGEN<x>:CH<n>:SIGNal, 3–80
- PGEN<x>:CH<n>:TDElAy, 3–81
- PGEN<x>:CH<n>:THOLd, 3–82
- PGEN<x>:CH<n>:TINPut, 3–83
- PGEN<x>:CH<n>:TRANsition, 3–83
- PGEN<x>:CH<n>:TYPE, 3–84
- PGEN<x>:CH<n>:WIDTh, 3–85
- \*PSC, 3–86, 3–132
- PURGE, 3–87
- Query, 3–9
- Quoted string argument, 3–14
- \*RCL, 3–88
- RS232?, 3–88
- RS232:BAUD, 3–89
- RS232:DElAy, 3–89
- RS232:ECHO, 3–90
- RS232:EOL, 3–91
- RS232:FLAGging, 3–92
- RS232:PARity, 3–93
- RS232:SBITs, 3–94
- \*RST, 3–95
- \*SAV, 3–96
- Separator, 3–10
- Set, 3–9
- SIGNAL:<parameter>, 3–96
- SIGNAL:BDATA, 3–98
- SIGNAL:BDATA:FILL, 3–99
- SIGNal:CVIEw, 3–100
- SIGNal:DATA, 3–101
- SIGNal:DATA:COPI, 3–102
- SIGNal:DRADix, 3–103
- SIGNal:TYPE, 3–104
- \*SRE, 3–105, 3–132
- \*STB?, 3–105, 3–130
- Syntax, BNF (Backus-Naur form), 3–9
- Table
  - Common command, 3–21
  - Device command, 3–22
- TBAS?, 3–106
- TBAS:COUNT, 3–106
- TBAS:FREQuency, 3–107
- TBAS:MODE, 3–108
- TBAS:PERiod, 3–109
- TBAS:PLIN?, 3–110
- TBAS:PLIN:INPut, 3–110
- TBAS:PVIEw, 3–109
- TBAS:RUN, 3–111
- TBAS:TIN?, 3–112
- TBAS:TIN:INPut, 3–112
- TBAS:TIN:LEVel, 3–113
- TBAS:TIN:SLOPe, 3–113
- TBAS:TIN:TRIGger, 3–114
- TBAS:TOUT?, 3–115
- TBAS:TOUT:PERiod, 3–115
- TBAS:TOUT:PRETrigger, 3–116
- \*TRG, 3–116
- \*TST?, 3–117
- VECTor?, 3–118
- VECTor:BDATA, 3–118
- VECTor:BIOfFormat, 3–121
- VECTor:DATA, 3–121
- VECTor:END, 3–123
- VECTor:IOFormat, 3–124
- VECTor:LOOP, 3–125
- VECTor:STARt, 3–125
- VERBOSE, 3–126
- \*WAI, 3–126
- Command syntax, BNF (Backus-Naur form), 3–9
- Common command, List, 3–21
- Concatenating, Command, 3–12
- Configuration, 2–43
  - Command query, 3–55
- Conflicts, 3–134
- Connector
  - FRAME SYNC IN**, 2–2, 2–3, 2–39, 2–64, 2–67, 2–68
  - GPIB**, 2–29, 3–1
  - OUTPUT**, 1–11, 2–2, 2–3, 2–7, 2–10
  - PHASE LOCK IN**, 2–2, 2–3, 2–39, 2–43, 2–64, 2–68
  - SERIAL PORT**, 2–53
  - SKREW CAL IN**, 2–2, 2–3, 2–7
  - TRANSDUCER**, 2–2, 2–3
  - TRANSDUCER IN**, 2–10, 2–49
  - TRIGGER IN**, 2–2, 2–3, 2–25, 2–62, 2–64, 2–67
  - TRIGGER OUT**, 1–11, 2–2, 2–3, 2–7, 2–27, 2–65, 2–68
- Constant** menu item, 2–21, 2–22
- Controller, GPIB, 3–1
- Copy Channel** menu item, 2–50
- Count Down, 2–22
- Count** menu item, 1–6, 1–7, 2–49, 2–62
- Count Up, 2–22

**D**

- Data Copy menu, 1–4
- Data Edit menu, 1–4
- Data Fill menu, 1–4
- Data Radix** menu item, 2–20
- Data time generator, 2–13
  - On/off, 2–14
  - Output, 2–14
  - ~Output, 2–14
- DCL, C–1
- Debug
  - Indicator
    - ATN, C–4
    - LADS, C–4
    - LLO, C–4
    - REM, C–4
    - RS232 Error, C–4
    - TADS, C–4
    - >XOFF, C–5
    - XOFF>, C–5
  - mode, C–4
- Debug** menu item, 2–33, 2–56, 3–5, 3–6
- Delay, Channel, 2–25
- Delay** menu item, 2–56, 3–6
- deleting a single vector, 2–23
- DESE command, 3–32, 3–131
- DESER register, 3–32, 3–86, 3–131
- Deskew, 2–25
  - Channel, 2–25
  - Trigger out, 2–27
- Device Clear, 3–9, C–1
- Device command, List, 3–22
- Diagnostics, Calibration memory failure, 2–8
- Diagram
  - Level, 2–36
  - Syntax, 3–19, 3–20
  - Timing, 2–1
  - Voltage, 2–36
- Dialog, 1–5
- Documentation, A–1
- Duty Cycle** menu item, 2–48
- Duty cycle view, 2–48, 3–82

**E**

- E (in Data Edit menu), 2–18
- Echo** menu item, 2–56, 3–5
- Edge Placement Checks, F–27
- EIA Std. RS-232-C interface, 3–1
- End vector indicator, 2–18
- ENTER** button, 1–8

- EOI (end or identify), 3–13
- EOL** menu item, 2–56, 3–6
- Error message, Programming interface, 3–135
- \*ESE command, 3–33, 3–132
- ESER register, 3–33, 3–86, 3–131
- \*ESR? command, 3–34
- \*ESR? query, 3–129
- Event handling, 3–134, 3–141
- Event query, 3–34
- Event queue, 3–34, 3–133
- EVENT? command, 3–34
- EVMSG? command, 3–34
- External clock, 2–39

**F**

- FACTORY command, 3–35
- Factory** menu item, 2–51, 2–58
- Fill Block with Method** menu item, 2–21, 2–23
- FINE** button, 1–7, 2–2, 2–3
- FINE** light, 1–8, 2–2, 2–3
- Flagging** menu item, 2–55, 3–5
- FPAN command
  - FPAN?, 3–38
  - FPAN:ADVance, 3–38
  - FPAN:BEND, 3–39
  - FPAN:BSIZE, 3–40
  - FPAN:BSart, 3–41
  - FPAN:CONStant, 3–41
  - FPAN:COPIes, 3–42
  - FPAN:CORDer, 3–43
  - FPAN:DCHannel, 3–40, 3–43
  - FPAN:DITem, 3–44
  - FPAN:DMENU, 3–45
  - FPAN:DNCHannel, 3–45
  - FPAN:DNSignal, 3–46
  - FPAN:DNStart, 3–46
  - FPAN:DSEtting, 3–47
  - FPAN:DSIGnal, 3–47
  - FPAN:DVEctOr, 3–48
  - FPAN:FSCale, 3–49
  - FPAN:KEY, 3–49
  - FPAN:KRESolution, 3–51
  - FPAN:MESSage, 3–52
  - FPAN:METHod, 3–52
  - FPAN:SORDer, 3–53
  - FPAN:VRADix, 3–54
- FRAME SYNC IN**
  - Connector, 2–2, 2–3, 2–39, 2–64, 2–67, 2–68
  - Impedance, 2–41
  - Voltage, 2–41
- Frequency, 1–8, 2–47, 2–62, 3–107, 3–109



Phase lock, 2–40  
 Frequency Accuracy Check, F–31  
**Frequency** menu item, 1–7, 2–40, 2–47, 2–62  
 Front panel control from programming interface  
   Auto Advance, 3–38  
   Block End/Size, 3–39  
   Block size, 3–40  
   Block start, 3–41  
   Copies, 3–42  
   Destination channel, 3–45  
   Destination signal, 3–46  
   Destination start address, 3–46  
   Display channel, 3–40, 3–43  
   Display vector, 3–48  
   Displayed item, 3–44  
   Displayed menu, 3–45  
   Displayed setting, 3–47  
   Displayed signal, 3–47  
   Fill method, 3–52  
   Fill scale, 3–49  
   Front panel channel order, 3–43  
   Front panel constant, 3–41  
   Key press, 3–49  
   Knob resolution, 3–51  
   Message, 3–52  
   Query, 3–38  
   Signal data radix, 3–103  
   Signal display order, 3–53  
   Vector radix, 3–54

## G

GET, C–1  
 Go to local, C–1  
 GPIB, 2–29  
   Address, 2–33, 3–4  
   Configurations, 3–3  
   Connection rules, 3–3  
   Debug, 2–33, 3–5  
   EOI (end or identify), 3–13  
   Function subsets, C–5  
   Interactive operation, 2–31  
   Menu, 1–4, 3–4  
   On bus, 2–33, 3–4  
   Parameter Setting, 3–4  
   Using a controller, 3–1  
**GPIB** connector, 2–29, 3–1  
 Group execute trigger, C–1  
 GTL, C–1

## H

Header  
   Command, 3–10, 3–54  
   Included in query response, 3–54, 3–126  
 HEADER command, 3–54  
**High Level** menu item, 2–36, 2–37, 2–46  
 High level view, 2–36, 2–46, 3–75  
**High Limit** menu item, 2–37  
**HIGH SPEED** pulse generator card, 2–47

## I

\*IDN? query, 3–55  
 IEEE Std. 488.2-1987, 3–1, 3–9, 3–21  
 Impedance  
   **FRAME SYNC IN** connector, 2–41  
   **PHASE LOCK IN** connector, 2–39  
   **TRANSDUCER IN** connector, 2–49  
 inserting a single vector, 2–23  
 Instrument Setup, F–13  
 Interface message, C–1  
 Invert, 2–22

## K

Keypad, 1–8, 2–2, 2–3  
 Knob, 2–2, 2–3

## L

L (in Data Edit menu), 2–18  
 LADS debug indicator, C–4  
 Lead delay view, 2–47, 3–72  
 Level and Amplitude Tests, F–19  
   HFS 9DG1, F–13  
   HFS 9DG2 and HFS 9PG2, F–16  
 Levels menu, 1–4, 2–36  
   Voltage diagram, 2–36  
 Light  
   **FINE**, 1–8, 2–2, 2–3  
   **REMOTE**, 2–2, 2–3, 2–31  
   **RUNNING**, 2–2, 2–3  
**Limit** menu item, 2–37  
 List  
   Common command, 3–21  
   Device command, 3–22  
 LLO, C–1

LLO debug indicator, C-4  
Local lock out, 3-144, C-1  
Loop vector indicator, 2-18  
**Low Level** menu item, 2-36, 2-37, 2-46  
Low level view, 2-36, 2-46, 3-75  
**Low Limit** menu item, 2-37  
\*LRN? query, 3-56

## M

Main menu, 1-3  
**MAIN MENU** button, 1-2, 2-2, 2-3, 2-4  
Manual trigger, 1-11, 2-64, 2-67  
    Simulation with command, 3-114, 3-116  
**MANUAL TRIGGER** button, 1-11, 2-2, 2-3, 2-62,  
    2-64, 2-67  
Manuals, A-1  
Map, Menu, 2-5, 2-6  
Menu  
    Cal/Deskew, 1-4, 2-7, 2-25, 2-43, 2-59, 2-61, 2-67  
    Data Copy, 1-4  
    Data Edit, 1-4  
    Data Fill, 1-4  
    GPIB, 1-4, 3-4  
    Levels, 1-4, 2-36  
        Voltage diagram, 2-36  
    Main, 1-3  
    Navigation, 2-4  
    Pulse, 1-4, 2-10, 2-35, 2-45  
        Timing diagram, 2-45  
    RS-232, 1-4  
    Save/Recall, 1-4, 2-51, 2-57  
    Signal, 1-4  
    Time Base, 1-4, 2-40, 2-61, 2-67  
    Vector, 1-4  
Menu Item  
    **Copy Channel**, 2-50  
    **Paste Channel**, 2-50  
Menu item  
    **Address**, 2-33, 3-4  
    **Amplitude**, 2-36, 2-46  
    **Baud Rate**, 2-55, 3-5  
    Blinking, 2-48, 2-64  
    **Calibrate**, 2-7  
    **Chan Delay**, 2-25  
    **Channel**, 2-25, 2-36, 2-46  
    **Count**, 1-6, 1-7, 2-49, 2-62  
    **Debug**, 2-33, 2-56, 3-5, 3-6  
    **Delay**, 2-56, 3-6  
    **Duty Cycle**, 2-48  
    **Echo**, 2-56, 3-5  
    **EOL**, 2-56, 3-6

**Factory**, 2-51, 2-58  
**Flagging**, 2-55, 3-5  
**Frequency**, 1-7, 2-40, 2-47, 2-62  
**High Level**, 2-36, 2-37, 2-46  
**High Limit**, 2-37  
**Limit**, 2-37  
**Low Level**, 2-36, 2-37, 2-46  
**Low Limit**, 2-37  
**Mode**, 1-6, 2-61, 2-68  
**Offset**, 2-36, 2-46  
**On Bus**, 2-33, 3-4  
**Out Period**, 2-65, 2-68  
**Output**, 2-10, 2-14, 2-46  
**~Output**, 2-10, 2-14, 2-46  
**Parity**, 2-55, 3-5  
**Period**, 1-7, 2-40, 2-47, 2-62  
**Lead Delay**, 2-26, 2-47  
**Phase**, 2-48  
**PhaseLockIn**, 2-40, 2-43, 2-64, 2-68  
**Polarity**, 2-46  
**Pretrigger**, 2-25, 2-65, 2-68  
**Pulse Rate**, 2-49  
**Purge**, 2-58  
**Recall**, 2-57  
**Reset**, 2-51  
**Save**, 2-58  
**Self Test**, 2-59  
**Setting**, 2-57  
**Stop Bits**, 2-55, 3-5  
**Trail Delay**, 2-48  
**Transducer**, 2-49  
**Transition**, 2-48  
**Trig Level**, 2-64, 2-68  
**Trig Slope**, 2-64, 2-68  
**Trigger In**, 2-41, 2-64, 2-67  
**View Config**, 2-43  
**Width**, 2-48  
Menu map, 2-5, 2-6  
Message  
    Command, 3-10  
    Command terminator, 3-13  
    Dialog, 1-5  
    Table of program messages, 3-135  
**Method** menu item, 2-21, 2-22  
Mnemonic, Command, 3-10  
**Mode** menu item, 1-6, 2-61, 2-68  
**Mode** menu item, 2-20  
**Move Up/Order** menu item, 2-17

## N

Naming channels, 2-14-2-24

Navigation, Menu, 2-4  
**NEXT CHANNEL** button, 2-2, 2-3, 2-11, 2-25, 2-36, 2-46  
 Nominal specifications, B-1  
 Numeric  
   Command argument, 3-16  
   Keypad, 1-8, 2-2, 2-3

**O**

**Offset** menu item, 2-36, 2-46  
 Offset view, 2-36, 2-46, 3-75  
**On Bus** menu item, 2-33, 3-4  
**ON/STANDBY** button, 2-2, 2-3  
 \*OPC command, 3-57  
 Operation complete command, 3-57  
 Operation complete wait, 3-126  
 \*OPT? query, 3-57  
 Optional identification query, 3-57  
**Out Period** menu item, 2-65, 2-68

**Output**  
   Amplitude, 2-46, 3-59  
   Channel delay, 2-25, 3-63  
   Duty cycle, 2-48, 3-67  
   Fall time, 2-48, 3-83  
   High, 2-36, 2-37, 2-46, 3-69  
   Lead delay, 2-47, 3-71  
   Limits, 2-37, 3-70, 3-73  
   Low, 2-36, 2-37, 3-74  
   Offset, 2-46, 3-76  
   On/off, 2-2, 2-3, 2-10, 2-14, 2-43, 2-46, 3-64, 3-77  
   Phase, 2-48, 3-78  
   Polarity, 2-46, 2-49, 3-79  
   Pulse rate, 2-49, 3-79  
   Pulse width, 2-48, 3-85  
   Queue, 3-133  
   Rise time, 2-48, 3-83  
   Trail delay, 2-48, 3-81  
   Transducer input, 2-49, 3-83  
   Transition, 2-48, 3-83  
   Voltages, 2-36, 2-46, 3-69, 3-74  
   Width, 2-48, 3-85

**OUTPUT** button, 1-11, 2-2, 2-3  
**OUTPUT** connector, 1-11, 2-2, 2-3, 2-7, 2-10, 2-14, 2-46  
 Output Level Checks  
   HFS 9DG1, F-13  
   HFS 9DG2 and HFS 9PG2, F-16  
   HFS 9PG1, F-19  
**Output** menu item, 2-10, 2-14, 2-46  
 Output queue, 3-133

**~Output** menu item, 2-10, 2-14, 2-46

## P

Parallel poll, C-1  
**Parity** menu item, 2-55, 3-5  
**Paste Channel** menu item, 2-50  
 Performance Verification Procedures, F-1  
 Period, 1-8, 2-47, 2-62, 3-109  
   Phase lock, 2-40  
**Period** menu item, 1-7, 2-40, 2-47, 2-62  
 PGEN<x>:CH<n> command  
   PGEN<x>?, 3-58  
   PGEN<x>:CH<n>?, 3-59  
   PGEN<x>:CH<n>:AMPLitude, 3-59  
   PGEN<x>:CH<n>:BDATA, 3-61  
   PGEN<x>:CH<n>:BDATA:FILL, 3-63  
   PGEN<x>:CH<n>:CDElAy, 3-63  
   PGEN<x>:CH<n>:COUtpuT, 3-64  
   PGEN<x>:CH<n>:CVIew, 3-65  
   PGEN<x>:CH<n>:DATA, 3-65  
   PGEN<x>:CH<n>:DATA:COpy, 3-66  
   PGEN<x>:CH<n>:DATA:SWAP, 3-67  
   PGEN<x>:CH<n>:DCYClE, 3-67  
   PGEN<x>:CH<n>:DRADix, 3-68  
   PGEN<x>:CH<n>:HIGH, 3-69  
   PGEN<x>:CH<n>:HLIMit, 3-70  
   PGEN<x>:CH<n>:LDElAy, 3-71  
   PGEN<x>:CH<n>:LHOLd, 3-72  
   PGEN<x>:CH<n>:LIMit, 3-73  
   PGEN<x>:CH<n>:LLIMit, 3-73  
   PGEN<x>:CH<n>:LOW, 3-74  
   PGEN<x>:CH<n>:LVIew, 3-75  
   PGEN<x>:CH<n>:OFFSet, 3-76  
   PGEN<x>:CH<n>:OUTPut, 3-77  
   PGEN<x>:CH<n>:PHASe, 3-78  
   PGEN<x>:CH<n>:POLarity, 3-79  
   PGEN<x>:CH<n>:PRATe, 3-79  
   PGEN<x>:CH<n>:SIGNal, 3-80  
   PGEN<x>:CH<n>:TDElAy, 3-81  
   PGEN<x>:CH<n>:THOLd, 3-82  
   PGEN<x>:CH<n>:TINPut, 3-83  
   PGEN<x>:CH<n>:TRANsition, 3-83  
   PGEN<x>:CH<n>:TYPE, 3-84  
   PGEN<x>:CH<n>:WIDTh, 3-85  
 Phase lock, 2-39, 2-43, 2-64, 2-68, 3-110  
   Period and Frequency, 2-40  
 Phase Lock Check, F-34  
**PHASE LOCK IN**  
   Connector, 2-2, 2-3, 2-39, 2-43, 2-64, 2-68  
   Impedance, 2-39  
   Voltage, 2-39

- Lead Delay** menu item, 2–26, 2–47
- Phase** menu item, 2–48
- Phase view, 2–47, 3–72
- PhaseLockIn** menu item, 2–40, 2–43, 2–64, 2–68
- Polarity** menu item, 2–46
- Power cord, A–2
- Power on, 2–43
- Power-on status clear command, 3–86
- PPC, C–1
- PPD, C–1
- PPE, C–1
- PPU, C–1
- Pretrigger** menu item, 2–25, 2–65, 2–68
- PREVIOUS CHANNEL** button, 2–2, 2–3, 2–11, 2–25, 2–36, 2–46
- \*PSC command, 3–86, 3–132
- Pulse generator, 2–45
  - Amplitude, 2–46, 3–59
  - Channel delay, 2–25, 3–63
  - Channel query, 3–59
  - Complementary output, 3–64
  - Duty cycle, 2–48, 3–67
  - Fall time, 2–48, 3–83
  - High, 2–36, 2–37, 2–46, 3–69
  - Lead delay, 2–47, 3–71
  - Leading hold, 3–72
  - Level view, 3–75
  - Limits, 2–37, 3–70, 3–73
  - Low, 2–36, 2–37, 3–74
  - Offset, 2–46, 3–76
  - On/off, 2–2, 2–3, 2–10, 2–43, 2–46, 3–64, 3–77
  - Output, 2–10, 2–46, 3–77
  - ~Output, 2–10, 2–46, 3–64
  - Phase, 2–48, 3–78
  - Polarity, 2–46, 2–49, 3–79
  - Pulse rate, 2–49, 3–79
  - Pulse width, 2–48, 3–85
  - Query, 3–58
  - Rise time, 2–48, 3–83
  - Trail delay, 2–48, 3–81
  - Trailing hold, 3–82
  - Transducer input, 2–49, 3–83
  - Transition, 2–48, 3–83
  - Voltages, 2–36, 2–46, 3–69, 3–74
  - Width, 2–48, 3–85
- Pulse menu, 1–4, 2–10, 2–35, 2–45
  - Timing diagram, 2–45
- Pulse Rate** menu item, 2–49, 2–65
- Pulse window, 2–1, 2–62
- PURGE command, 3–87
- Purge** menu item, 2–58
- Purge setting command, 3–87

## Q

- Query, Header in query response, 3–54, 3–126
- Query command, 3–9
- Queue
  - Event, 3–133
  - Output, 3–133
- Quoted string, Command argument, 3–14

## R

- Rack mount, A–2
- Random, 2–22
- \*RCL command, 3–88
- Recall** menu item, 2–57
- Recall setting command, 3–88
- Register
  - DESER, 3–32, 3–86, 3–131
  - ESER, 3–33, 3–86, 3–131
  - SBR, 3–105, 3–130
  - SESR, 3–31, 3–34, 3–57, 3–129
  - SRER, 3–86, 3–105, 3–132
- REM debug indicator, C–4
- REMOTE** light, 2–2, 2–3, 2–31
- Required Test Equipment, F–1
- Reserved words, C–3
- Reset, 1–5
  - Calibration memory, 2–51
  - Command, 3–95
  - Factory, 2–51, 3–35
  - Total instrument, 2–51
- Reset** menu item, 2–51
- Reset Order** menu item, 2–17
- Rise Time and Fall Time Checks (HFS 9PG1 and HFS 9DG1 Cards Only), F–22
- Rise Time and Fall Time Checks (HFS 9PG2 and HFS 9DG2 Cards Only), F–25
- RS-232-C, 2–53
  - Additional information you need about your computer, 3–6
  - Baud rate, 2–55, 3–5
  - Debug, 2–56, 3–6
  - Delay, 2–56, 3–6
  - Echo, 2–56, 3–5
  - EOL (End of Line), 2–56, 3–6
  - Flagging, 2–55, 3–5
  - Parity, 2–55, 3–5
  - Stop bits, 2–55, 3–5
  - Terminal, 3–6
  - Using a terminal, 3–6
- RS-232 menu, 1–4

- RS-232-C
    - Baud rate, 3–89
    - Cables, C–6
    - Delay, 3–89
    - Echo, 3–90
    - EOL (End of Line), 3–91
    - Flagging, 3–92
    - Parity, 3–93
    - Query, 3–88
    - Stop bits, 3–94
    - Wiring, C–6
  - RS232 command
    - RS232?, 3–88
    - RS232:BAUD, 3–89
    - RS232:DELAy, 3–89
    - RS232:ECHO, 3–90
    - RS232:EOL, 3–91
    - RS232:FLAGging, 3–92
    - RS232:PARity, 3–93
    - RS232:SBITs, 3–94
  - RS232 Error debug indicator, C–4
  - \*RST command, 3–95
  - RUN/STOP** button, 2–2, 2–3
  - RUNNING** light, 2–2, 2–3
- ## S
- S (in Data Edit menu), 2–18
  - \*SAV command, 3–96
  - Save** menu item, 2–58
  - Save setting command, 3–96
  - Save/Recall menu, 1–4, 2–51, 2–57
  - SBR register, 3–105, 3–130
  - SDC, C–1
  - SELECT** button, 1–3, 2–2, 2–3, 2–4
  - Selected device clear, C–1
  - Selecting
    - Channels, 2–11
    - Menu, 2–4
  - Self Test, F–11
  - Self test, 2–59, 3–117
  - Self Test** menu item, 2–59
  - Separator, Command, 3–10
  - Serial poll, 3–130
    - Disable, C–1
    - Enable, C–1
  - SERIAL PORT** connector, 2–53
  - Service request enable command, 3–105
  - Service request enable register, 3–105
  - SESR register, 3–31, 3–34, 3–57, 3–129
  - Set command, 3–9
  - Setting
    - Command query, 3–56
    - Purge command, 3–87
    - Query, 3–56
    - Recall command, 3–88
    - Save command, 3–96
  - Setting** menu item, 2–57
  - Settings, 2–57
  - Signal, 2–16
    - Data Fill (Binary), 3–99
    - Data Input/Output (Binary), 3–98
    - Parameter Setting, 3–96
  - SIGNAL command
    - SIGNAL:<parameter>, 3–96
    - SIGNAL:BDATA, 3–98
    - SIGNAL:BDATA:FILL, 3–99
  - SIGNAL command
    - SIGNAL:CVIEW, 3–100
    - SIGNAL:DATA, 3–101
    - SIGNAL:DATA:COPY, 3–102
    - SIGNAL:TYPE, 3–104
  - Signal command, SIGNAL:DRADix, 3–103
  - Signal Menu, 2–14
  - Signal menu, 1–4
  - Signal Name** menu item, 2–14
  - Signal Type** menu item, 2–16, 2–46
  - Single-step operation, 2–63
  - SKEW CAL IN** connector, 2–2, 2–3, 2–7
  - SPD, C–1
  - SPE, C–1
  - Specified characteristics, B–8
  - \*SRE command, 3–105, 3–132
  - SRER register, 3–86, 3–105, 3–132
  - SRQ** button, 2–2, 2–3, 2–31
  - Start vector indicator, 2–18
  - Startup delay, 2–1, 2–62
  - Status and error commands, ALLEV?, 3–29
  - \*STB? query, 3–105, 3–130
  - Stop Bits** menu item, 2–55, 3–5
  - Synchronizing to external signal, 2–39
  - Syntax
    - BNF (Backus-Naur form), 3–9
    - Diagram, 3–19, 3–20
- ## T
- Table
    - ASCII character, C–2
    - Common command, 3–21
    - Device command, 3–22
    - Programming message, 3–135
    - Reserved words, C–3
  - TADS debug indicator, C–4

- TBAS command
    - TBAS?, 3-106
    - TBAS:COUNT, 3-106
    - TBAS:FREQUENCY, 3-107
    - TBAS:MODE, 3-108
    - TBAS:PERIOD, 3-109
    - TBAS:PLIN?, 3-110
    - TBAS:PLIN:INPUT, 3-110
    - TBAS:PVIEW, 3-109
    - TBAS:RUN, 3-111
    - TBAS:TIN?, 3-112
    - TBAS:TIN:INPUT, 3-112
    - TBAS:TIN:LEVEL, 3-113
    - TBAS:TIN:SLOPE, 3-113
    - TBAS:TIN:TRIGGER, 3-114
    - TBAS:TOUT?, 3-115
    - TBAS:TOUT:PERIOD, 3-115
    - TBAS:TOUT:PRETRIGGER, 3-116
  - Tek Std. Codes and Formats 1989, 3-21
  - Terminal, RS-232-C, 3-6
  - Terminator, Command message, 3-13
  - Time base, 2-61
    - Count, 1-6, 1-7, 2-49, 2-62, 3-106
    - Frequency, 1-7, 2-40, 2-47, 2-62, 3-107
    - Frequency view, 1-8, 2-47, 2-62, 3-109
    - Manual trigger simulation, 3-114, 3-116
    - Mode, 1-7, 2-61
      - Auto, 1-7, 2-63, 3-108
      - Auto-burst, 1-7, 2-63, 3-108
      - Burst, 1-7, 2-1, 2-62, 3-108
      - Trig-Auto, 1-7
      - Trig-Auto, 2-63
    - Period, 1-7, 2-40, 2-47, 2-62, 3-109
    - Period view, 1-8, 2-47, 2-62, 3-109
    - Phase lock, 2-39, 2-43, 2-64, 2-68, 3-110
    - Phase lock query, 3-110
    - Pretrigger, 2-27, 2-65, 2-68, 3-116
    - Query, 3-106
    - Run, 3-111
    - Run/Stop, 2-63
    - Startup delay, 2-62
    - Time zero reference, 2-1, 2-62
    - Trigger in, 2-25, 2-62, 3-112
    - Trigger in query, 3-112
    - Trigger level, 2-64, 2-68, 3-113
    - Trigger out, 2-27, 2-65, 2-68
    - Trigger out period, 2-65, 2-68, 3-115
    - Trigger out query, 3-115
    - Trigger slope, 2-64, 2-68, 3-113
  - Time Base menu, 1-4, 2-40, 2-61, 2-67
  - Time zero reference, 2-1, 2-62
  - Timing, Diagram, 2-1
  - Trail Delay** menu item, 2-48
  - Trail delay view, 2-48, 3-82
  - TRANSDUCER IN**
    - Connector, 2-2, 2-3, 2-10, 2-49
    - Impedance, 2-49
    - Voltage, 2-49
  - Transducer** menu item, 2-49
  - Transition** menu item, 2-48
  - \*TRG command, 3-116
  - Trig Level** menu item, 2-64, 2-68
  - Trig Slope** menu item, 2-64, 2-68
  - Trig-Auto, Time base mode, 1-7, 2-63
  - Trig-Auto, Time base mode, 2-20
  - Trigger, 2-67
    - Burst mode, 2-41
    - Frame sync, 2-39
    - In, 2-25, 2-39, 3-112
    - Level, 2-64, 2-68, 3-113
      - Diagram, 2-36
    - Out, 2-27, 2-65, 2-68, 3-115
      - Deskew, 2-27
    - Out period, 2-65, 2-68, 3-115
    - Phase lock, 2-39, 2-43, 2-64, 2-68, 3-110
    - Pretrigger, 2-27, 2-65, 2-68, 3-116
    - Slope, 2-64, 2-68, 3-113
  - Trigger command, 3-116
  - TRIGGER IN** connector, 2-2, 2-3, 2-25, 2-62, 2-64, 2-67
  - Trigger In** menu item, 2-41, 2-64, 2-67
  - TRIGGER OUT** connector, 1-11, 2-2, 2-3, 2-7, 2-27, 2-65, 2-68
  - \*TST? query, 3-117
  - Typical specifications, B-11
- ## U
- UNDO** button, 1-9, 2-2, 2-3
  - UNL, C-1
  - Unlisten, C-1
  - UNT, C-1
  - Untalk, C-1
- ## V
- VAR RATE** pulse generator card, 2-35, 2-47
  - Vec Radix** menu item, 2-20, 2-24
  - VECTOR commands
    - BDATA, 3-118
    - BIOFormat, 3-121
    - DATA, 3-121
    - END, 3-123
    - IOFormat, 3-124
    - LOOP, 3-125

START, 3–125  
VECTor?, 3–118  
Vector menu, 1–4  
VERBOSE command, 3–126  
Verification Sequence, F–11  
Version number, 2–43  
**View Config** menu item, 2–43  
**View** menu item, 2–16, 2–21  
Voltage  
  Amplitude, 2–46, 3–59  
  Diagram, 2–36  
  **FRAME SYNC IN** connector, 2–41  
  High, 2–36, 2–37, 2–46, 3–69  
  Limits, 2–37, 3–70, 3–73  
  Low, 2–36, 2–37, 3–74  
  Offset, 2–46, 3–76  
  **PHASE LOCK IN** connector, 2–39

**TRANSDUCER IN** connector, 2–49

## W

\*WAI command, 3–126  
Wait for operation complete, 3–126  
**Width** menu item, 2–48  
Width view, 2–48, 3–82  
Window, Pulse, 2–1, 2–62

## X

>XOFF debug indicator, C–5  
XOFF> debug indicator, C–5  
Xon/Xoff, 2–55, 3–5







